

FEATURES

- Advanced programmable PLL design
- Very low Jitter and Phase Noise (30-70ps Pk-Pk typical)
- Up to 3 programmable outputs
- Output frequency up to 200MHz CMOS.
- Accepts Crystal or reference clock inputs
 - Fundamental crystal: 10MHz-30MHz
 - 3RD overtone crystal: Up to 75MHz
 - Reference input: Up to 200MHz
- Accepts <1.0V reference signal input voltage
- One programmable I/O pin can be configured as Programmable clock, or Frequency Selection input, or output Enable (OE) or Power Down (PDB) input.
- Supply operating range 2.25V to 3.63V
- Operating temperature range from -40°C to 85°C
- Available in 8-pin MSOP/SOP, and 6-pin SOT Green/ RoHS compliant Packages

PIN CONFIGURATION

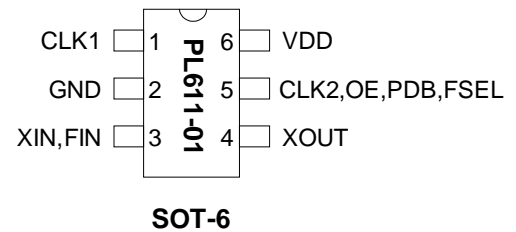
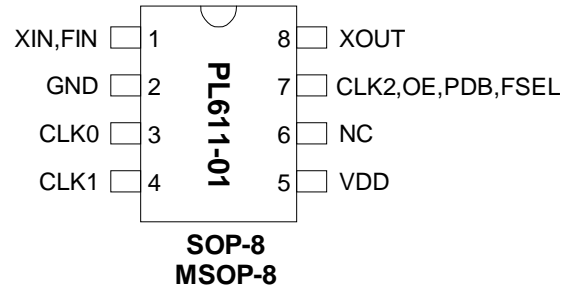

DESCRIPTION

The PL611-01 is a low-cost general purpose frequency synthesizer and a member of Programmable Clock family. PL611-01 product family offers the versatility of using a single Crystal or Reference Clock input and producing up to three different system clocks. They can generate any output frequency up to 200 MHz from fundamental crystal input between 10 MHz - 30 MHz, or a 3rd overtone crystal of up to 75MHz, or a Reference clock input of up to 200 MHz. Cascading of the ICs to produce additional clock frequencies is also supported.

BLOCK DIAGRAM

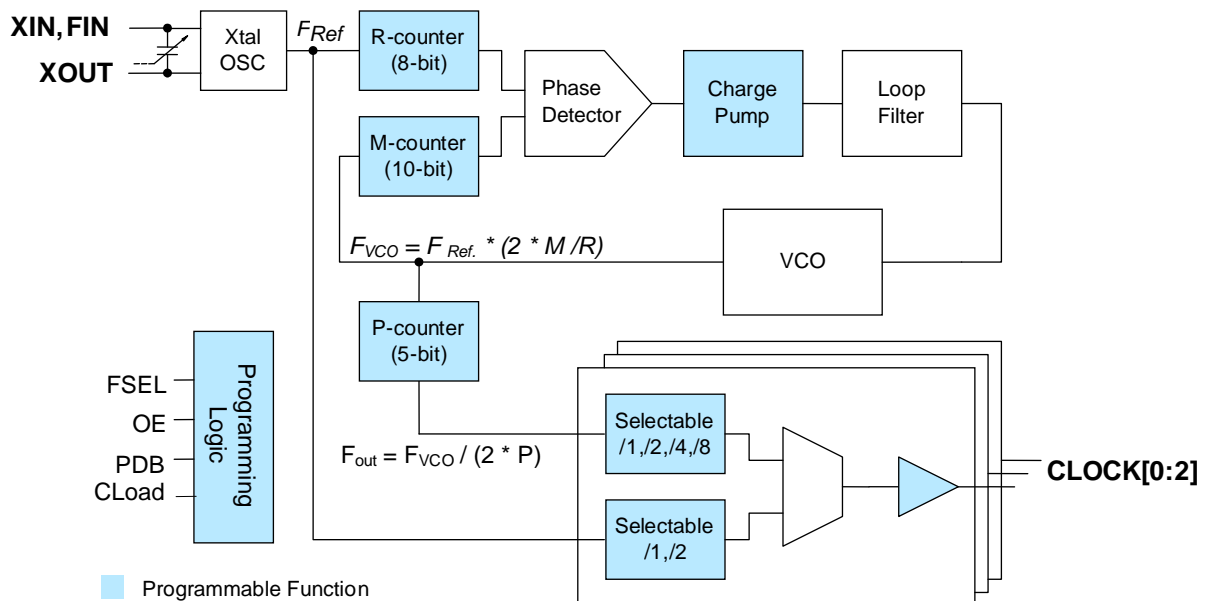

KEY PROGRAMMING PARAMETERS

CLK[0:2] Output Frequency	Output Drive Strength	Crystal Load	Programmable Input/Output	Charge-Pump Current
$F_{OUT} = F_{REF} * M / (R * P)$ where M=10 bit R= 8 bit P= 5 bit $CLK[0:2] = F_{out} / (1,2,4,8), F_{REF} \text{ OR } F_{REF} / 2$	Std: 10mA (default) High: 24mA	+/- 200ppm tuning.	One output pin can be configured as 1. CLK2 - output 2. FSEL - input 3. OE - input 4. PDB - input	4 levels of pump current settings

PIN DESCRIPTION

Name	Pin #		Type	Description												
	MSOP-8 SOIC-8	SOT-23														
XIN, FIN	1	3	I	Crystal or Reference input pin												
GND	2	2	P	GND connection												
CLK[0:1]	3,4	1	O	Programmable Clock Output												
VDD	5	6	P	VDD connection (2.25~3.63V)												
NC	6			No Connect												
CLK2, OE, PDB, FSEL	7	5	B	This programmable I/O pin can be configured as a programmable clock output (CLK2), or Output Enable (OE) input, or Power Down input (PDB), or Frequency Selection (FSEL) input pin. This pin has an internal 60KΩ pull up resistor. <table border="1" data-bbox="852 1381 1481 1556"> <thead> <tr> <th>State</th> <th>OE</th> <th>PDB</th> <th>FSEL</th> </tr> </thead> <tbody> <tr> <td>0</td> <td>Tristate CLK[0:1]</td> <td>Power Down Mode</td> <td>Select Freq. '1'</td> </tr> <tr> <td>1 (default)</td> <td>Normal mode</td> <td>Normal mode</td> <td>Select Freq. '2'</td> </tr> </tbody> </table>	State	OE	PDB	FSEL	0	Tristate CLK[0:1]	Power Down Mode	Select Freq. '1'	1 (default)	Normal mode	Normal mode	Select Freq. '2'
State	OE	PDB	FSEL													
0	Tristate CLK[0:1]	Power Down Mode	Select Freq. '1'													
1 (default)	Normal mode	Normal mode	Select Freq. '2'													
XOUT	8	4	O	Crystal output pin												

ELECTRICAL SPECIFICATIONS
ABSOLUTE MAXIMUM RATINGS

PARAMETERS	SYMBOL	MIN.	MAX.	UNITS
Supply Voltage Range	V_{DD}	-0.5	4.6	V
Input Voltage Range	V_i	-0.5	$V_{DD}+0.5$	V
Output Voltage Range	V_o	-0.5	$V_{DD}+0.5$	V
Soldering Temperature (Green package)			260	°C
Storage Temperature	T_s	-65	150	°C
Ambient Operating Temperature		-40	85	°C

Exposure of the device under conditions beyond the limits specified by Maximum Ratings for extended periods may cause permanent damage to the device and affect product reliability. These conditions represent a stress rating only, and functional operations of the device at these or any other conditions above the operational limits noted in this specification is not implied. *Operating temperature is guaranteed by design. Parts are tested to commercial grade only.

AC SPECIFICATIONS

PARAMETERS	CONDITIONS	MIN.	TYP.	MAX.	UNITS
Crystal Input Frequency(XIN)	Fundamental Crystal	10		30	MHz
	3 rd Overtone Crystal			75	MHz
Input (FIN) Frequency				200	MHz
Input (FIN) Signal Amplitude	Internally AC coupled	0.9		V_{DD}	V _{pp}
Settling Time	At power-up (after V_{DD} increases over 2.25V)			2	ms
Output Enable Time	OE Function; $T_a=25^\circ\text{C}$, 15pF Load			100	μs
	PDB Function; $T_a=25^\circ\text{C}$, 15pF Load			2	ms
PLL Settling Time	After Crystal Start Up (Crystal Input)			100	μs
	After Reference Input Present (FIN)			100	μs
Output Rise Time	15pF Load, 10/90% V_{DD} , Standard drive		2.5	3.5	ns
	15pF Load, 10/90% V_{DD} , High drive		1.0	1.5	ns
Output Fall Time	15pF Load, 90/10% V_{DD} , Standard drive		2.5	3.5	ns
	15pF Load, 90/10% V_{DD} , High drive		1.0	1.5	ns
Duty Cycle	At $V_{DD}/2$	45	50	55	%
Max. output skew between same frequency clocks	Equal loading (15 pF). Equal frequency & drive strength			500	ps
Period Jitter, peak-to-peak* (10,000 samples measured)	With capacitive decoupling between V_{DD} and GND. Operating only one output.		70		ps

* Note: Jitter performance depends on the programming parameters.

DC SPECIFICATIONS

PARAMETERS	SYMBOL	CONDITIONS	MIN.	TYP.	MAX.	UNITS
Supply Current, Dynamic, with Loaded Outputs	I _{DD}	At 10MHz, load=15pF (PDB=1)			15	mA
		PDB=0			5	μA
Operating Voltage	V _{DD}		2.25		3.63	V
Output Low Voltage	V _{OL}	I _{OL} = +4mA Standard drive			0.4	V
Output High Voltage	V _{OH}	I _{OH} = -4mA Standard drive	V _{DD} - 0.4			V
Output Current, Standard drive	I _{OSD}	V _{OL} = 0.4V, V _{OH} = 2.4V			10	mA
Output Current, High drive	I _{OHD}	V _{OL} = 0.4V, V _{OH} = 2.4V			24	mA
Short-circuit Current	I _S			±50		mA

CRYSTAL SPECIFICATIONS

PARAMETERS	SYMBOL	MIN.	TYP.	MAX.	UNITS
Fundamental Crystal Resonator Frequency	F _{XIN}	10		30	MHz
3 rd Overtone Crystal Resonator Frequency	F _{XIN}			75	MHz
Crystal Loading Rating (The IC can be programmed for any value in this range.)	C _{L (xtal)}	5		20	pF
Maximum Sustainable Drive Level				500	μW
Operating Drive Level			100		μW
Crystal Shunt Capacitance	C ₀			6	pF
Effective Series Resistance, Fundamental, 10-30MHz	ESR			30	Ω
Effective Series Resistance, 3 rd Overtone, 30-50MHz [C ₀ < 4pF, C _L =(5pF)/(8pF)]	ESR			100/70	Ω
Effective Series Resistance, 3 rd Overtone, 50-65MHz, [C ₀ < 4pF, C _L =5pF(5pF)/(8pF)]	ESR			60/40	Ω
Effective Series Resistance, 3 rd Overtone, 65-75MHz [C ₀ < 4pF, C _L =(5pF)/(8pF)]	ESR			45/30	Ω

PACKAGE DRAWINGS (GREEN PACKAGE COMPLIANT)

MSOP-8L

Symbol	Dimension in MM	
	Min.	Max.
A	---	1.10
A1	0.05	0.15
A2	0.81	0.91
B	0.25	0.40
C	0.13	0.23
D	2.90	3.10
E	2.90	3.10
H	4.90 BSC	
L	0.445	0.648
e	0.65 BSC	

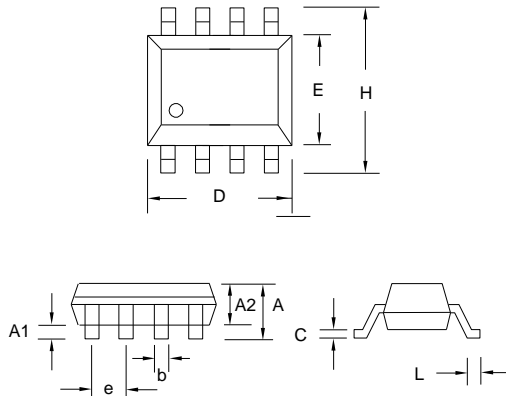

SOP-8L

Symbol	Dimension in MM	
	Min.	Max.
A	1.35	1.75
A1	0.10	0.25
A2	1.25	1.50
B	0.33	0.53
C	0.19	0.27
D	4.80	5.00
E	3.80	4.00
H	5.80	6.20
L	0.40	0.89
e	1.27 BSC	

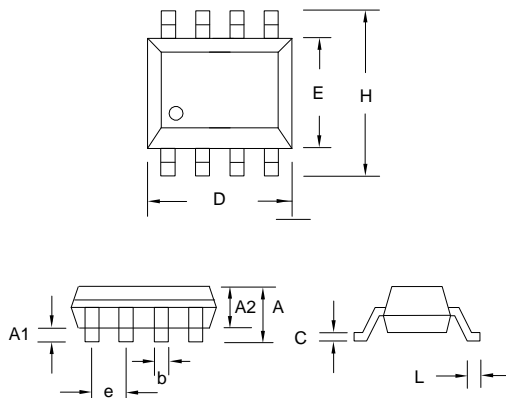

SOT23-6 L

Symbol	Dimension in MM	
	Min.	Max.
A	1.05	1.45
A1	0.05	0.15
A2	0.90	1.30
b	0.30	0.50
C	0.08	0.22
D	2.80 BSC	
E	1.60 BSC	
H	2.80 BSC	
L	0.30	0.60
e	0.95 BSC	

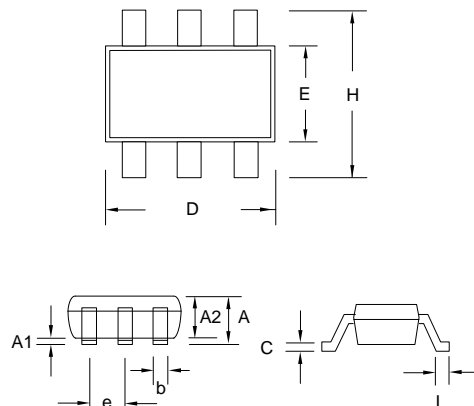

ORDERING INFORMATION (GREEN PACKAGE COMPLIANT)

For part ordering, please contact our Sales Department:

2180 Fortune Drive, San Jose, CA 95131, USA
 Tel: (408) 944-0800 Fax: (408) 474-1000

PART NUMBER

The order number for this device is a combination of the following:
 Part number, Package type and Operating temperature range

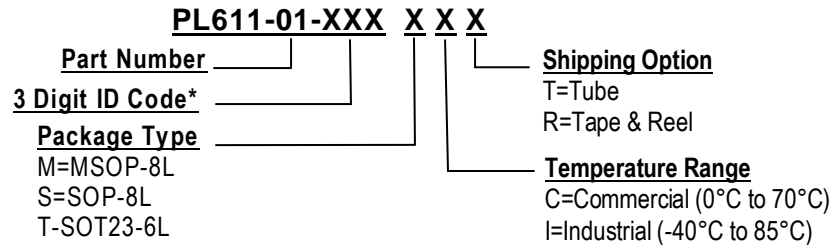

* Micrel will assign a unique 3-digit ID code for each approved programmed part number.

Part / Order Number	Marking	Part / Order Number	Marking	Package Option
PL611-01-XXXMC	C1XXX	PL611-01-XXXMI	C1XXX	8-Pin MSOP (Tube)
PL611-01-XXXMC-R	LLL	PL611-01-XXXMI-R	LLLI	8-Pin MSOP (Tape and Reel)
PL611-01-XXXSC	P611-01 XXX	PL611-01-XXXSI	P611-01 XXXI	8-Pin SOP (Tube)
PL611-01-XXXSC-R	LLLLL	PL611-01-XXXSI-R	LLLLL	8-Pin SOP (Tape and Reel)
PL611-01-XXXTC	C1XXX	PL611-01-XXXTI	C1XXX	6-Pin SOT-23 (Tape)
PL611-01-XXXTC-R	LLL	PL611-01-XXXTI-R	LLLI	6-Pin SOT-23 (Tape and Reel)

† Note: 'XXX' designates marking identifier that, at times, could be independent of the part number.
 "LLL" and "LLLLL" means assembly from which lot number.

Micrel Inc., reserves the right to make changes in its products or specifications, or both at any time without notice. The information furnished by Micrel is believed to be accurate and reliable. However, Micrel makes no guarantee or warranty concerning the accuracy of said information and shall not be responsible for any loss or damage of whatever nature resulting from the use of, or reliance upon this product.

LIFE SUPPORT POLICY: Micrel's products are not authorized for use as critical components in life support devices or systems without the express written approval of the President of Micrel Inc.