

General Description

The Micrel MIC2202 is a high efficiency 2MHz PWM synchronous buck regulator. The fast 2MHz operation along with a proprietary compensation scheme allows the smallest possible external components. The MIC2202 can operate with a 1 μ F ceramic output capacitor and a small, low DC-resistance, 2.2 μ H inductor, reducing system size and cost while allowing a high level of efficiency.

The MIC2202 operates from 2.3V to 5.5V input and features internal power MOSFETs that can supply over 600mA of output current with output voltages down to 0.5V. The MIC2202 implements a constant 2MHz pulse-width-modulation (PWM) control scheme which reduces noise in sensitive RF, audio, and communications applications. Additionally, the MIC2202 can be synchronized to an external clock, or multiple MIC2202s can easily be daisy-chained with the SYNCLOCK feature.

The MIC2202 has a high bandwidth loop (up to 500kHz) which allows ultra fast transient response times. This is very useful when powering applications that require fast dynamic response such as CPU cores and RF circuitry in high performance cellular phones and PDAs. The MIC2202 is available in 10-pin MSOP and 10-pin 3mm x 3mm MLF[®] package options with an operating junction temperature range from -40°C to +125°C.

Data sheets and support documentation can be found on Micrel's web site at: www.micrel.com.

Features

- Input voltage range: 2.3V to 5.5V
- Output down to 0.5V/600mA
- 2MHz PWM operation
- Stable with 1 μ F ceramic output capacitor.
- Ultra-fast transient response (up to 500kHz GBW)
- Internal compensation
- All ceramic capacitors
- >95% efficiency
- Fully integrated MOSFET switches
- Easily synchronized to external clock
- SYNCLOCK feature to daisy chain multiple 2202s
- Requires only 4 external components
- 1% line and load regulation
- Logic controlled micropower shutdown
- Thermal shutdown and current limit protection
- 10-pin MSOP and 10-pin 3mmx3mm MLF[®] package options
- -40°C to +125°C junction temperature range

Applications

- Cellular phones
- PDAs
- 802.11 WLAN power supplies
- FPGA/ASIC power supplies
- Dynamically adjustable power supply for CDMA/W-CDMA RF power amps
- DSL modems
- Tape drives

Typical Application

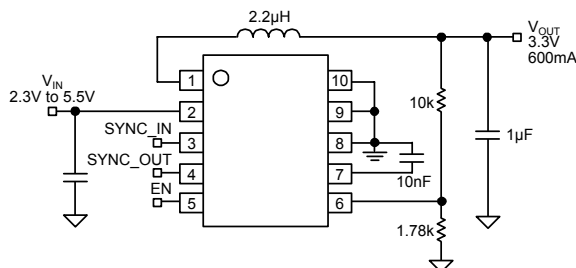

Adjustable Output Synchronous Buck Regulator

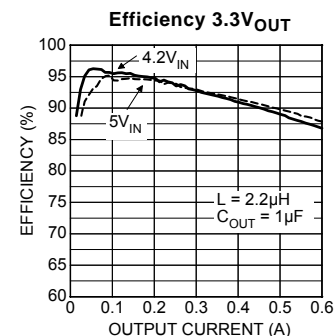

MLF and MicroLeadFrame are registered trademarks of Amkor Technology, Inc.

Micrel Inc. • 2180 Fortune Drive • San Jose, CA 95131 • USA • tel +1 (408) 944-0800 • fax + 1 (408) 474-1000 • <http://www.micrel.com>

Ordering Information

Part Number	Voltage	Temperature Range	Package	Lead Finish
MIC2202BMM	Adj.	-40° to +125°C	10-Pin MSOP	Standard
MIC2202BML	Adj.	-40° to +125°C	10-Pin MLF [®]	Standard
MIC2202YMM	Adj.	-40° to +125°C	10-Pin MSOP	Pb-Free
MIC2202YML	Adj.	-40° to +125°C	10-Pin MLF [®]	Pb-Free

Pin Configuration

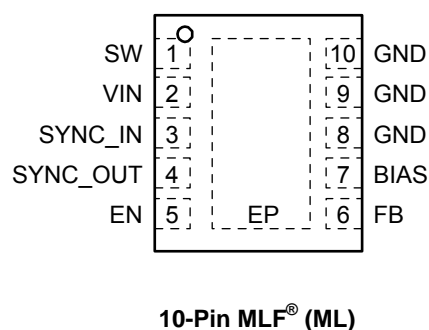
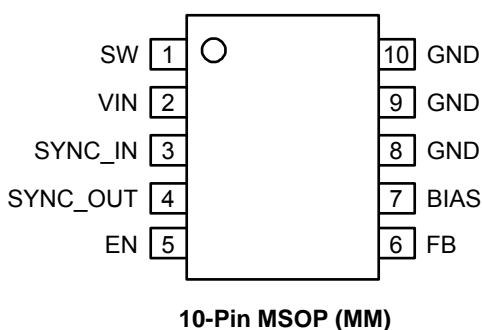

Pin Description

Pin Number	Pin Name	Pin Function
1	SW	Switch (Output): Internal power MOSFET output switches.
2	VIN	Supply Voltage (Input): Requires bypass capacitor to GND.
3	SYNC_IN	SYNC_IN for the MIC2202: Sync the main switching frequency to an external clock.
4	SYNC_OUT	SYNC_OUT an open collector output.
5	EN	A low level EN will power down the device, reducing the quiescent current to under 1 μ A.
6	FB	Input to the error amplifier, connect to the external resistor divider network to set the output voltage.
7	BIAS	Internal circuit bias supply, nominally 2.3V. Must be de-coupled to signal ground with a 0.01 μ F capacitor.
8, 9, 10	GND	Ground.
EP	GND	Ground, backside pad.

Absolute Maximum Ratings⁽¹⁾

Supply Voltage (V_{IN})	6V
Output Switch Voltage (V_{SW})	6V
Logic Input Voltage (V_{EN}, V_{SYNC_IN})	V_{IN} to $-0.3V$
Power Dissipation	Note 3
Storage Temperature (T_s)	$-65^{\circ}C$ to $+150^{\circ}C$
ESD Rating ⁽⁴⁾	2kV

Operating Ratings⁽²⁾

Supply Voltage (V_{IN})	+2.3V to +5.5V
Junction Temperature (T_J)	$-40^{\circ}C \leq T_J \leq +125^{\circ}C$
Package Thermal Resistance	
MSOP-10L (θ_{JA})	115 $^{\circ}C/W$
3x3 MLF-10 (θ_{JA})	60 $^{\circ}C/W$

Electrical Characteristics⁽⁵⁾

$T_A = 25^{\circ}C$ with $V_{IN} = 3.5V$ unless otherwise noted; **bold** values indicate $-40^{\circ}C \leq T_J \leq +125^{\circ}C$.

Parameter	Condition	Min	Typ	Max	Units
Supply Voltage Range		2.3		5.5	V
Quiescent Current	$EN = V_{IN}; V_{FB} = 0.55V$ (not switching)		350	450	μA
	$EN = 0V$		0.01	1	μA
MIC2202 [Adjustable] Feedback Voltage		0.4875	0.5	0.5125	V
Output Voltage Line Regulation	$V_{OUT} < 2V; V_{IN} = 2.3V$ to $5.5V, I_{LOAD} = 100mA$		0.05	0.5	%
Output Voltage Load Regulation	$0mA < I_{LOAD} < 500mA$		0.1	0.5	%
Bias Regulator Output Voltage		2.2	2.32	2.6	V
Maximum Duty Cycle	$V_{FB} = 0.7V$	100			%
Current Limit	$V_{FB} = 0.7V$	1	1.8	2.5	A
Switch ON-Resistance	$V_{IN} = 3.5V, I_{SW} = 300mA; V_{FB} = 0.35V$		0.65	0.9	Ω
	$V_{IN} = 3.5V, I_{SW} = 300mA; V_{FB} = 0.55V$		0.55	0.75	Ω
Enable Input Current			0.01	1	μA
Sync Frequency Range		1.6		2.5	MHz
SYNC_IN Threshold		0.7	1	1.7	V
Sync Minimum Pulse Width			10		ns
SYNC_IN Input Current				1	μA
Oscillator Frequency		1.8	2	2.2	MHz
Enable Threshold		0.5	0.9	1.3	V
Enable Hysteresis			20		mV
Over-temperature Shutdown			160		$^{\circ}C$
Over-temperature Shutdown Hysteresis			20		$^{\circ}C$

Notes:

- Exceeding the absolute maximum rating may damage the device.
- The device is not guaranteed to function outside its operating rating.
- Absolute maximum power dissipation is limited by maximum junction temperature where $P_{D(MAX)} = (T_{J(MAX)} - T_A) \div \theta_{JA}$.
- Devices are ESD sensitive. Handling precautions recommended. Human body model, 1.5k in series with 100pF.
- Specification for packaged product only.

Typical Characteristics

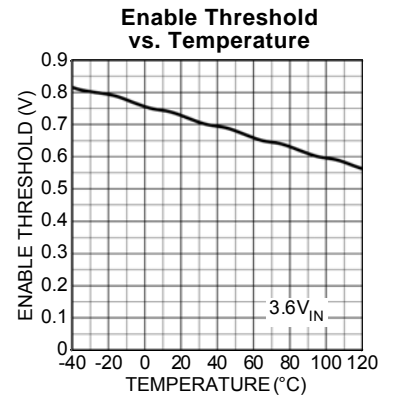
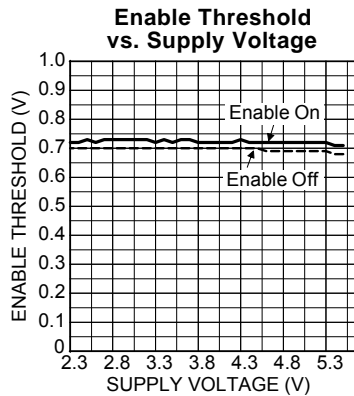
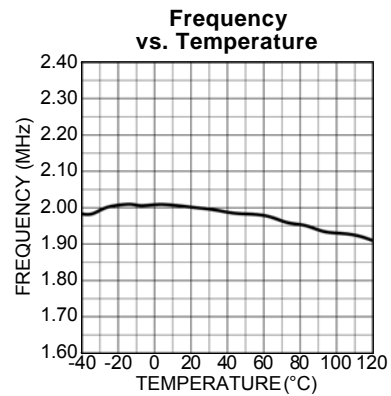
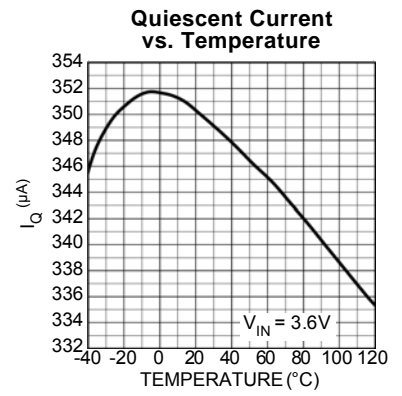
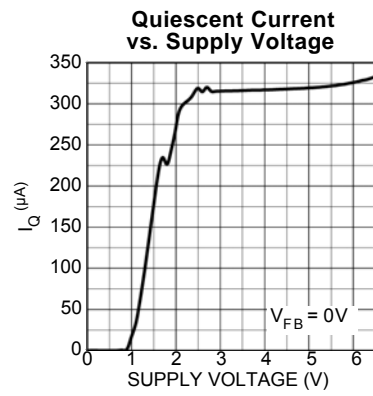
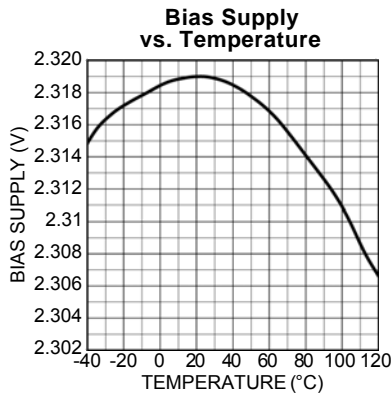
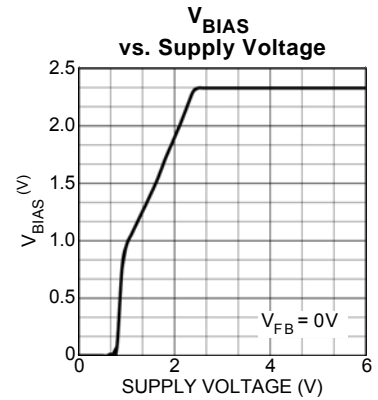
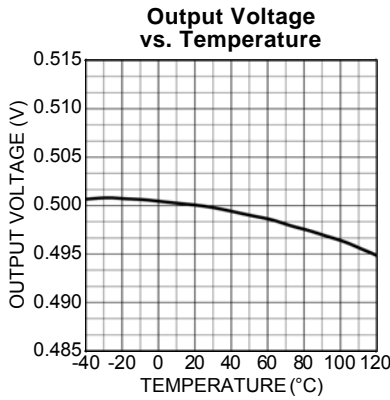
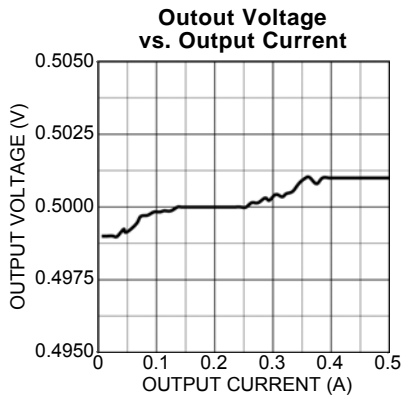

Block Diagram

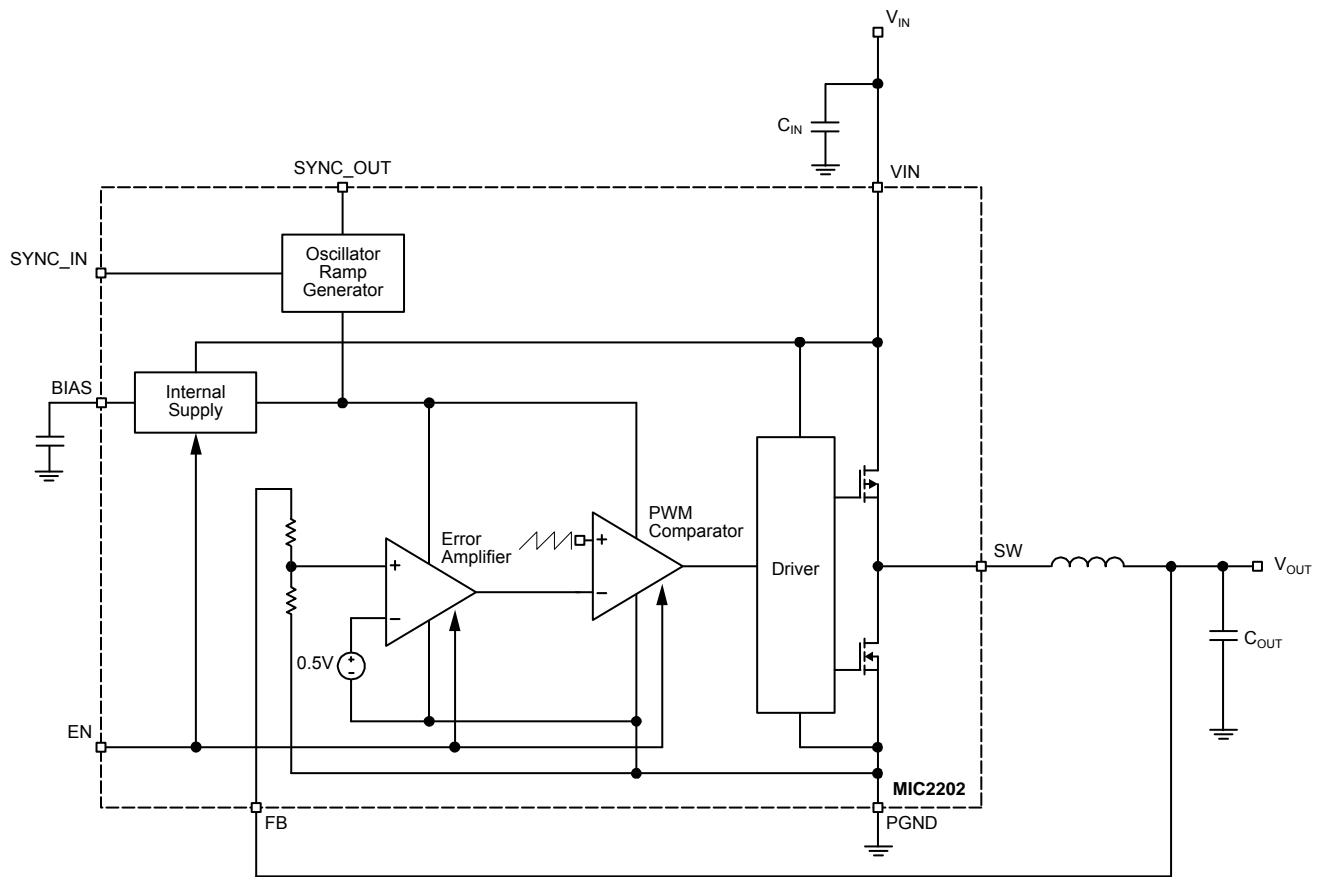

MIC2202 Block Diagram

Functional Description

VIN

VIN provides power to the output and to the internal bias supply. The supply voltage range is from 2.3V to 5.5V. A minimum 1 μ F ceramic is recommended for bypassing the input supply.

Enable

The enable pin provides a logic level control of the output. In the off state, supply current of the device is greatly reduced (typically <1 μ A). Also, in the off state, the output drive is placed in a “tri-stated” condition, where both the high side P-Channel MOSFET and the low-side N-Channel are in an off or non-conducting state. Do not drive the enable pin above the supply voltage.

Sync_In

Sync_In pin enables the ability to change the fundamental switching frequency. The Sync_In frequency has a minimum frequency of 1.6MHz and a maximum sync frequency of 2.5MHz.

Careful attention should be paid to not driving the Sync_In pin greater than the supply voltage. While this will not damage the device, it can cause improper operation.

Sync_Out

Sync_Out is an open collector output that provides a signal equal to the internal oscillator frequency. This creates the ability for multiple MIC2202s to be connected together in a master-slave configuration for frequency matching of the converters. A typical 10k Ω is recommended for a pull-up resistor.

Bias

The bias supply is an internal 2.3V linear regulator that supplies the internal biasing voltage to the MIC2202. A 10nF ceramic capacitor is required on this pin for bypassing. Do not use the bias pin as a supply. The bias pin was designed to supply internal power only.

Feedback

The feedback pin provides the control path to control the output. A resistor divider connecting the feedback to the output is used to adjust the desired output voltage. Refer to the feedback section in the “Applications Information” for more detail.

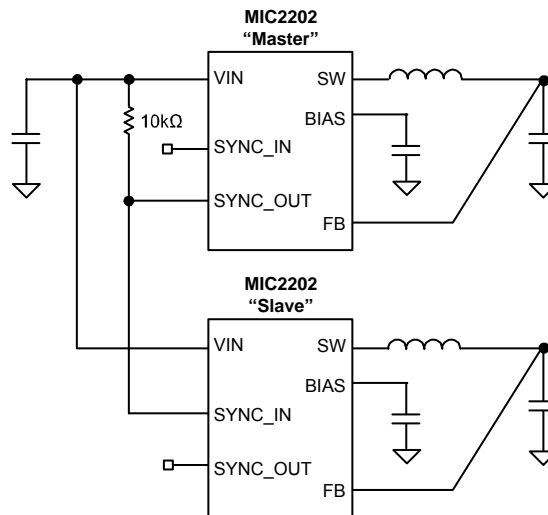

Figure 1. Master-Slave Operation

Application Information

Input Capacitor

A minimum 1 μ F ceramic is recommended on the VIN pin for bypassing. X5R or X7R dielectrics are recommended for the input capacitor. Y5V dielectrics, aside from losing most of their capacitance over temperature, they also become resistive at high frequencies. This reduces their ability to filter out high frequency noise.

Output Capacitor

The MIC2202 was designed specifically for the use of a 1 μ F ceramic output capacitor. This value can be increased to improve transient performance. Since the MIC2202 is voltage mode, the control loop relies on the inductor and output capacitor for compensation. For this reason, do not use excessively large output capacitors. The output capacitor requires either an X7R or X5R dielectric. Y5V and Z5U dielectric capacitors, aside from the undesirable effect of their wide variation in capacitance over temperature, become resistive at high frequencies. Using Y5V or Z5U capacitors will cause instability in the MIC2202.

Total output capacitance should not exceed 15 μ F. Large values of capacitance can cause current limit to engage during start-up. If larger than 15 μ F is required, a feed-forward capacitor from the output to the feedback node should be used to slow the start up time.

Inductor Selection

Inductor selection will be determined by the following (not necessarily in the order of importance):

- Inductance
- Rated current value
- Size requirements
- DC resistance (DCR)

The MIC2202 is designed for use with a 1 μ H to 4.7 μ H inductor.

Maximum current ratings of the inductor are generally given in two methods: permissible DC current and saturation current. Permissible DC current can be rated either for a 40°C temperature rise or a 10% loss in inductance. Ensure the inductor selected can handle the maximum operating current. When saturation current is specified, make sure that there is enough margin that the peak current will not saturate the inductor.

The size requirements refer to the area and height requirements that are necessary to fit a particular design. Please refer to the inductor dimensions on their datasheet.

DC resistance is also important. While DCR is inversely proportional to size, DCR can represent a significant efficiency loss. Refer to the "Efficiency Considerations"

below for a more detailed description.

Bias Capacitor

A small 10nF ceramic capacitor is required to bypass the bias pin. The use of low ESR ceramics provides improved filtering for the bias supply.

Efficiency Considerations

Efficiency is defined as the amount of useful output power, divided by the amount of power consumed.

$$\text{Efficiency \%} = \left(\frac{V_{\text{OUT}} \times I_{\text{OUT}}}{V_{\text{IN}} \times I_{\text{IN}}} \right) \times 100$$

Maintaining high efficiency serves two purposes. It reduces power dissipation in the power supply, reducing the need for heat sinks and thermal design considerations and it reduces consumption of current for battery powered applications. Reduced current draw from a battery increases the devices operating time, critical in hand held devices.

There are two loss terms in switching converters: DC losses and switching losses. DC losses are simply the power dissipation of I^2R . Power is dissipated in the high side switch during the on cycle. Power loss is equal to the high side MOSFET $R_{\text{DS(ON)}}$ multiplied by the Switch Current². During the off cycle, the low side N-Channel MOSFET conducts, also dissipating power. Device operating current also reduces efficiency. The product of the quiescent (operating) current and the supply voltage is another DC loss. The current required to drive the gates on and off at a constant 2MHz frequency and the switching transitions make up the switching losses.

Figure 2 shows an efficiency curve. The non-shaded portion, from 0mA to 200mA, efficiency losses are dominated by quiescent current losses, gate drive and transition losses. In this case, lower supply voltages yield greater efficiency in that they require less current to drive the MOSFETs and have reduced input power consumption.

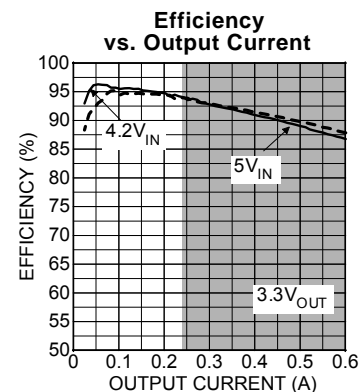

Figure 2. Efficiency Curve

The shaded region, 200mA to 500mA, efficiency loss is dominated by MOSFET $R_{DS(ON)}$ and inductor DC losses. Higher input supply voltages will increase the Gate-to-Source threshold on the internal MOSFETs, reducing the internal $R_{DS(ON)}$. This improves efficiency by reducing DC losses in the device. All but the inductor losses are inherent to the device. In which case, inductor selection becomes increasingly critical in efficiency calculations. As the inductors are reduced in size, the DC resistance (DCR) can become quite significant. The DCR losses can be calculated as follows;

$$LPD = I_{OUT2} \times DCR$$

From that, the loss in efficiency due to inductor resistance can be calculated as follows:

$$\text{Efficiency Loss} = \left[1 - \left(\frac{V_{OUT} \times I_{OUT}}{V_{OUT} \times I_{OUT} + L_{PD}} \right) \right] \times 100$$

Efficiency loss due to DCR is minimal at light loads and gains significance as the load is increased. Inductor selection becomes a trade-off between efficiency and size in this case.

Alternatively, under lighter loads, the ripple current due to the inductance becomes a significant factor. When light load efficiencies become more critical, a larger inductor value maybe desired. Larger inductances reduce the peak-to-peak ripple current which minimize losses. The following graph illustrates the effects of inductance value at light load.

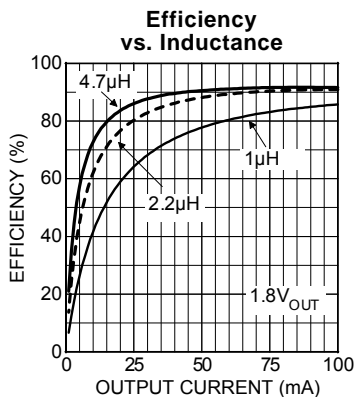

Figure 3. Efficiency vs. Inductance

Compensation

The MIC2202 is an internally compensated, voltage mode buck regulator. Voltage mode is achieved by creating an internal 2MHz ramp signal and using the output of the error amplifier to pulse width modulate the switch node, maintaining output voltage regulation. With a typical gain bandwidth of 200kHz, the MIC2202 is capable of extremely fast transient responses.

The MIC2202 is designed to be stable with a 2.2µH inductor and a 1µF ceramic (X5R) output capacitor.

These values can be interchanged (i.e. 1µH inductor and a 2.2µF capacitor). The trade off between changing these values is that with a larger inductor, there is a reduced peak-to-peak current which yields a greater efficiency at lighter loads. A larger output capacitor will improve transient response by providing a larger hold up reservoir of energy to the output.

Feedback

The MIC2202 provides a feedback pin to adjust the output voltage to the desired level. This pin connects internally to an error amplifier. The error amplifier then compares the voltage at the feedback to the internal 0.5V reference voltage and adjusts the output voltage to maintain regulation. To calculate the resistor divider network for the desired output is as follows:

$$R2 = \frac{R1}{\left(\frac{V_{OUT}}{V_{REF}} - 1 \right)}$$

Where V_{REF} is 0.5V and V_{OUT} is the desired output voltage. A 10kΩ or lower resistor value from the output to the feedback is recommended. Larger resistor values require an additional capacitor (feed-forward) from the output to the feedback. The large high side resistor value and the parasitic capacitance on the feedback pin (~10pF) can cause an additional pole in the loop. The additional pole can create a phase loss at high frequency. This phase loss degrades transient response by reducing phase margin. Adding feed-forward capacitance negates the parasitic capacitive effects of the feedback pin. A minimum 1000pF capacitor is recommended for feed-forward capacitance.

Also, large feedback resistor values increase the impedance, making the feedback node more susceptible to noise pick-up. A feed-forward capacitor would also reduce noise pick-up by providing a low impedance path to the output.

PWM Operation

The MIC2202 is a pulse width modulation (PWM) controller. By controlling the ratio of on-to-off time, or duty cycle, a regulated DC output voltage is achieved. As load or supply voltage changes, so does the duty cycle to maintain a constant output voltage. In cases where the input supply runs into a dropout condition, the MIC2202 will run at 100% duty cycle.

The MIC2202 provides constant switching at 2MHz with synchronous internal MOSFETs. The internal MOSFETs include a high-side P-Channel MOSFET from the input supply to the switch pin and an N-Channel MOSFET from the switch pin to ground. Since the low-side N-Channel MOSFET provides the current during the off cycle, a free wheeling Schottky diode from the switch node to ground is not required.

PWM control provides fixed frequency operation. By maintaining a constant switching frequency, predictable fundamental and harmonic frequencies are achieved. Other methods of regulation, such as burst and skip modes, have frequency spectrums that change with load that can interfere with sensitive communication equipment.

Synchronization

Sync_In allows the user to change the frequency from 2MHz up to 2.5MHz or down to 1.6MHz. This allows the ability to control the fundamental frequency and all the resultant harmonics. Maintaining a predictable frequency

creates the ability to either shift the harmonics away from sensitive carrier and IF frequency bands or to accurately filter out specific harmonic frequencies.

The Sync_Out function pin allows for the ability to be able to sync up multiple MIC2202s in a “daisy-chain”, connecting Sync_Out to Sync_In of the other MIC2202. Synchronizing multiple MIC2202s benefits much in the same way as syncing up one MIC2202. All regulators will run at the same fundamental frequency, resulting in matched harmonic frequencies, simplifying designing for sensitive communication equipment.

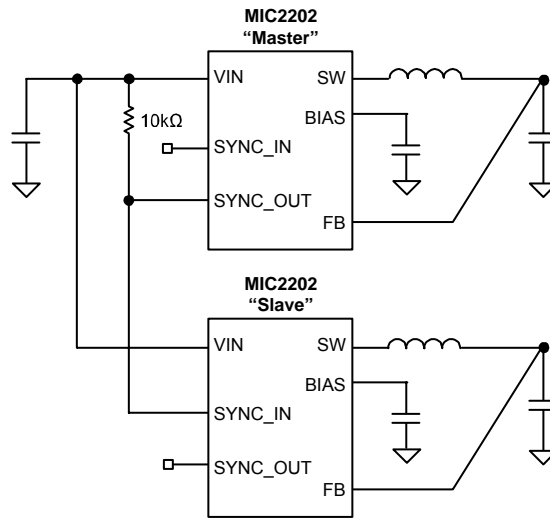

Figure 4. Master-Slave Operation

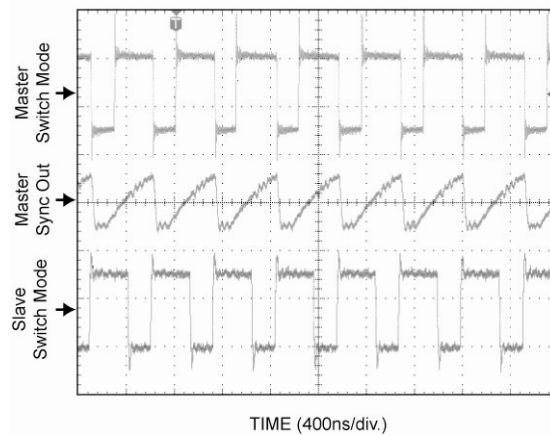
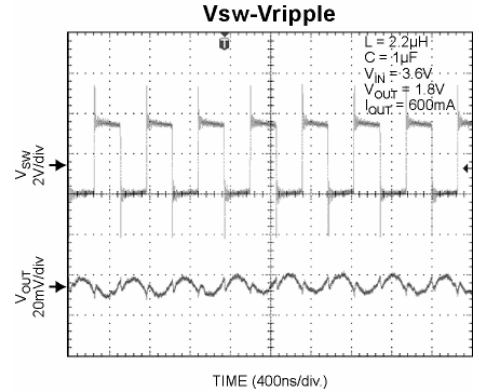
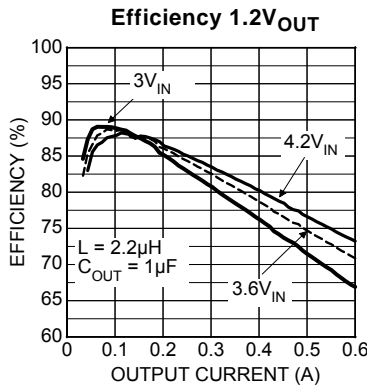
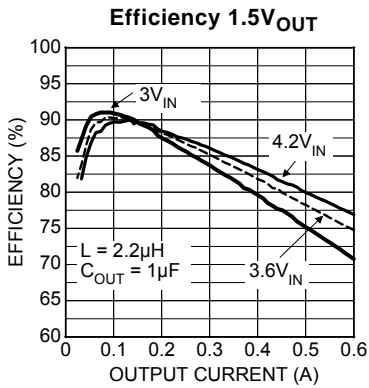
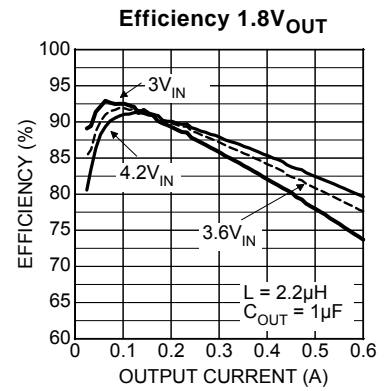
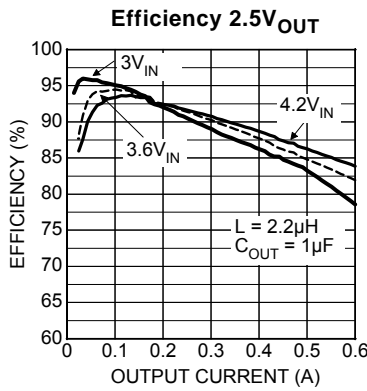
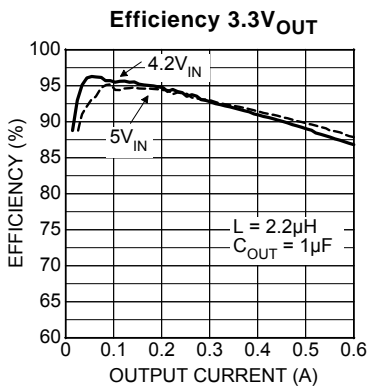
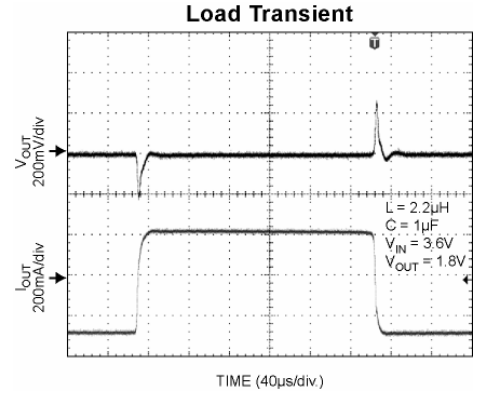
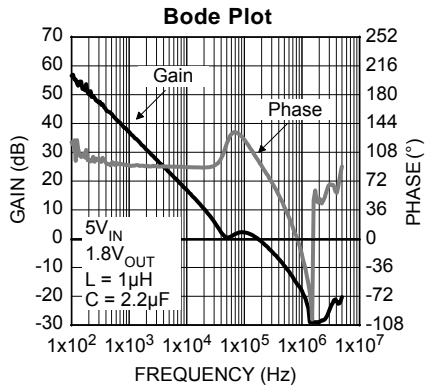
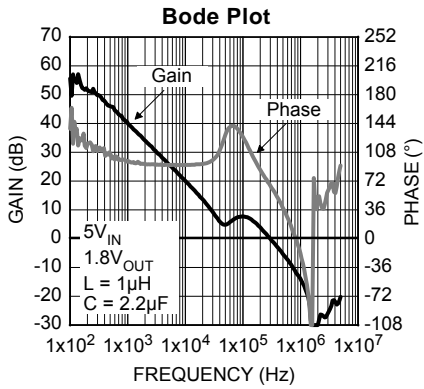

Figure 5. Master-Slave Synchronization Waveforms

MIC2202BMM with 2.2μH Inductor and 1μF Output Capacitor



MIC2202BMM with 2.2μH Inductor and 1μF Output Capacitor

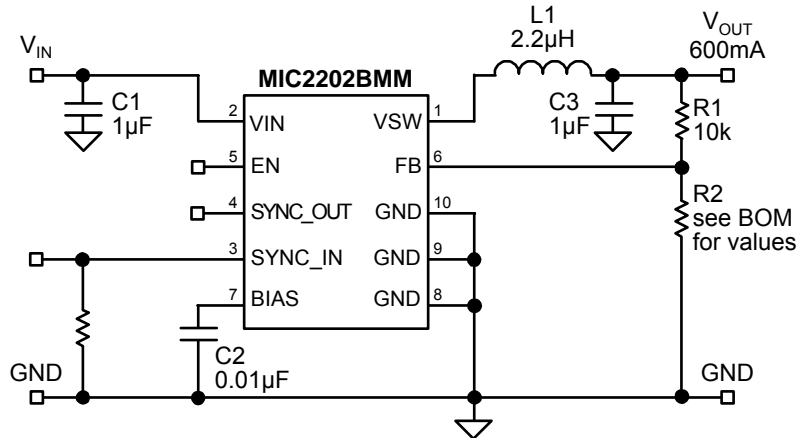

Figure 6. MIC2202BMM Schematic

Bill of Materials

Item	Part Number	Manufacturer	Description	Qty.
C1, C3	06036D105MAT2	AVX ⁽¹⁾	1μF Ceramic Capacitor X5R, 6.3V, Size 0603	2
	GRM185R60J105KE21D	Murata ⁽²⁾		
C2	0201ZD103MAT2	AVX ⁽¹⁾	10nF Ceramic Capacitor 6.3V, Size 0201	1
	GRM033R10J103KA01D	Murata ⁽²⁾	10nF Ceramic Capacitor 6.3V, Size 0202	
L1	LQH32CN2R2M53K	Murata ⁽²⁾	2.2μH Inductor 97mΩ (3.2mmx2.5mmx1.55mm)	1
	CDRH2D14-2R2	Sumida ⁽³⁾	2.2μH Inductor 94mΩ (3.2mmx3.2mmx1.55mm)	
R1	CRCW04021002F	Vishay-Dale ⁽⁴⁾	10kΩ 1%, Size 0402	1
R2	CRCW04021781F	Vishay-Dale ⁽⁴⁾	1.78kΩ 1%, Size 0402 For 3.3V _{OUT}	1
	CRCW04022491F		2.49kΩ 1%, Size 0402 For 2.5V _{OUT}	
	CRCW04023831F		3.83kΩ 1%, Size 0402 For 1.8V _{OUT}	
	CRCW04024991F		4.99kΩ 1%, Size 0402 For 1.5V _{OUT}	
	CRCW04027151F		7.15kΩ 1%, Size 0402 For 1.2V _{OUT}	
	CRCW04021002F		10kΩ 1%, Size 0402 For 1V _{OUT}	
	N/A		Open For 0.5V _{OUT}	
U1	MIC2202BMM	Micrel, Inc. ⁽⁵⁾	2MHz High Efficiency Synchronous Buck Regulator	1

Notes:

1. AVX: www.avx.com
2. Murata: www.murata.com
3. Sumida: www.sumida.com
4. Vishay-Dale: www.vishay.com
5. Micrel, Inc.: www.micrel.com

MIC2202BMM with 1 μ H Inductor and 2.2 μ F Output Capacitor

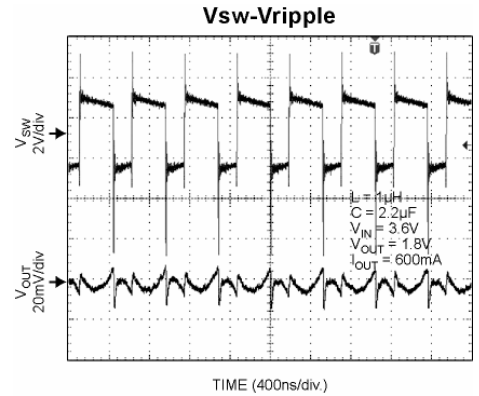
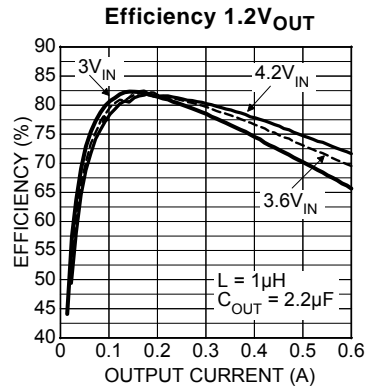
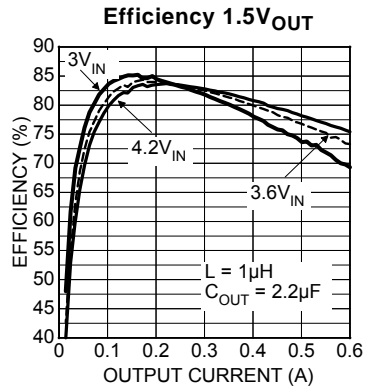
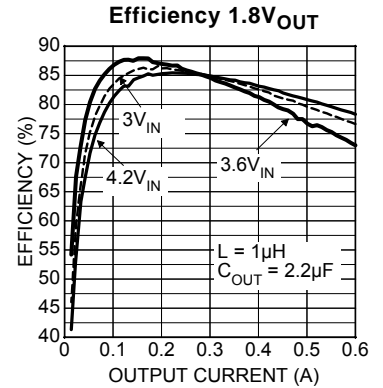
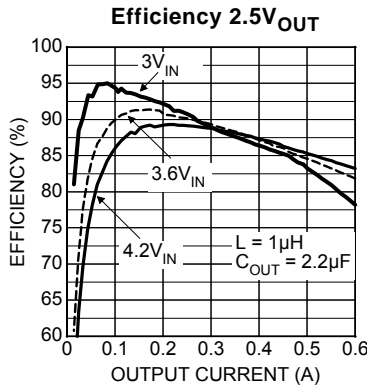
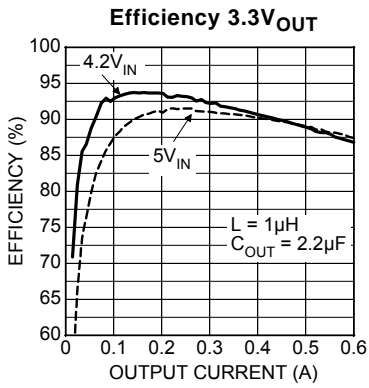
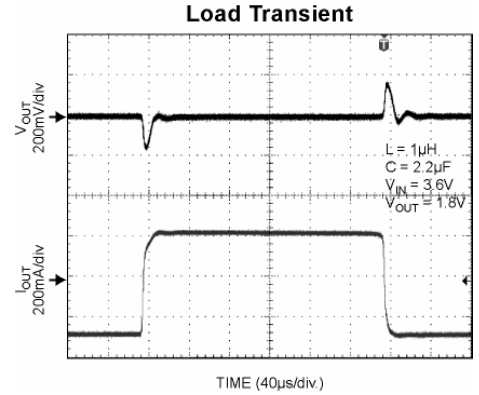
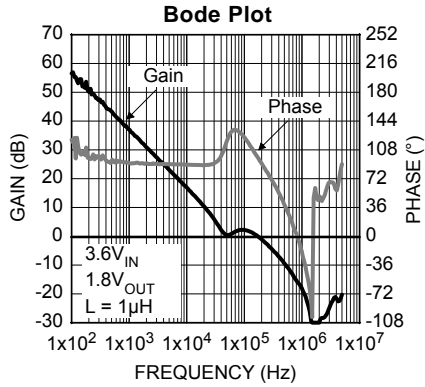
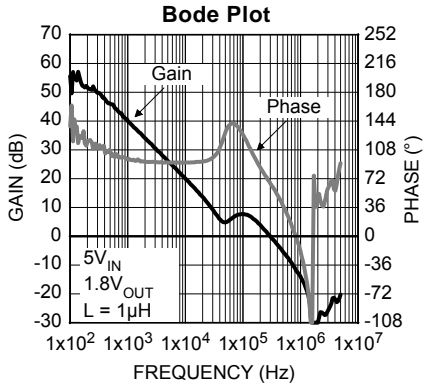

MIC2202BMM with 1μH Inductor and 2.2μF Output Capacitor

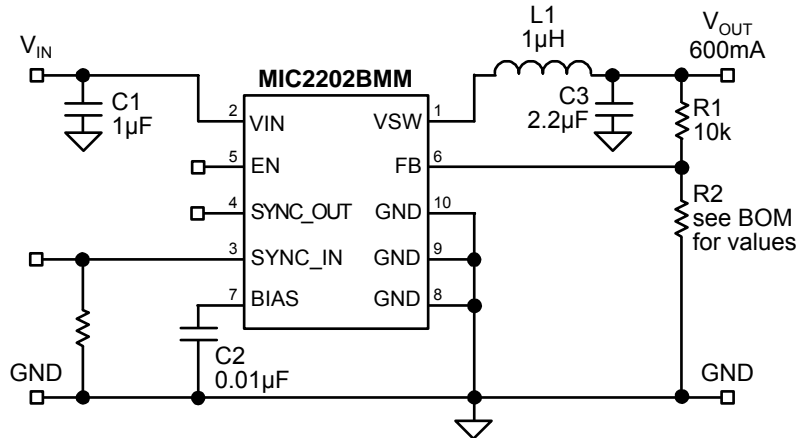

Figure 7. MIC2202BMM Schematic

Bill of Materials

Item	Part Number	Manufacturer	Description	Qty.
C1	06036D105MAT2	AVX ⁽¹⁾	1μF Ceramic Capacitor X5R, 6.3V, Size 0603	1
	GRM185R60J105KE21D	Murata ⁽²⁾		
C2	0201ZD103MAT2	AVX ⁽¹⁾	10nF Ceramic Capacitor 6.3V, Size 0201	1
	GRM033R10J103KA01D	Murata ⁽²⁾	10nF Ceramic Capacitor 6.3V, Size 0202	
C3	06036D225MAT2	AVX ⁽¹⁾	2.2μF Ceramic Capacitor X5R, 6.3V, Size 0603	1
	GRM033R10J103KA01D	Murata ⁽²⁾		
L1	LQH32CN1R0M53K	Murata ⁽²⁾	1μH Inductor 60mΩ (3.2mmx2.5mmx1.55mm)	1
	CDRH2D14-2R2	Sumida ⁽³⁾	1.5μH Inductor 63mΩ (3.2mmx3.2mmx1.55mm)	
R1	CRCW04021002F	Vishay-Dale ⁽⁴⁾	10kΩ 1%, Size 0402	1
R2	CRCW04021781F	Vishay-Dale ⁽⁴⁾	1.78kΩ 1%, Size 0402 For 3.3V _{OUT}	1
	CRCW04022491F		2.49kΩ 1%, Size 0402 For 2.5V _{OUT}	
	CRCW04023831F		3.83kΩ 1%, Size 0402 For 1.8V _{OUT}	
	CRCW04024991F		4.99kΩ 1%, Size 0402 For 1.5V _{OUT}	
	CRCW04027151F		7.15kΩ 1%, Size 0402 For 1.2V _{OUT}	
	CRCW04021002F		10kΩ 1%, Size 0402 For 1V _{OUT}	
	N/A		Open For 0.5V _{OUT}	
U1	MIC2202BMM	Micrel, Inc. ⁽⁵⁾	2MHz High Efficiency Synchronous Buck Regulator	1

Notes:

1. AVX: www.avx.com
2. Murata: www.murata.com
3. Sumida: www.sumida.com
4. Vishay-Dale: www.vishay.com
5. Micrel, Inc.: www.micrel.com

MIC2202BMM with 4.7μH Inductor and 1μF Output Capacitor

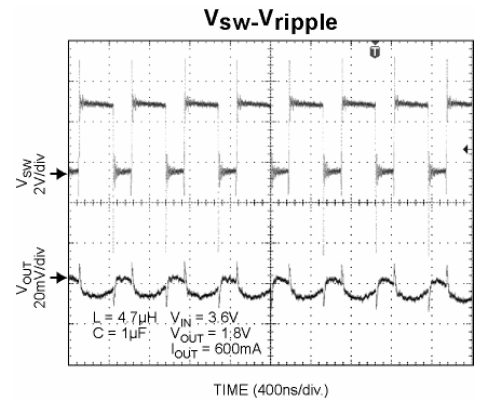
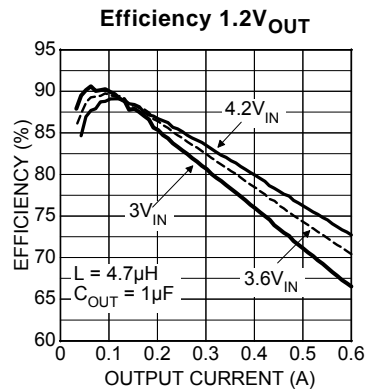
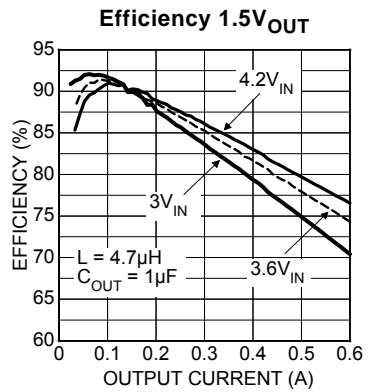
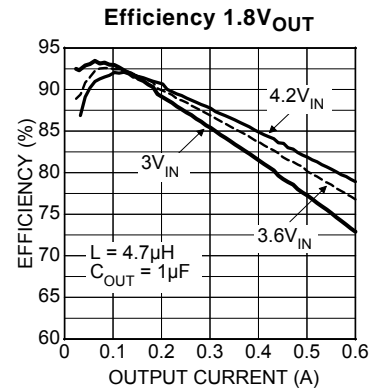
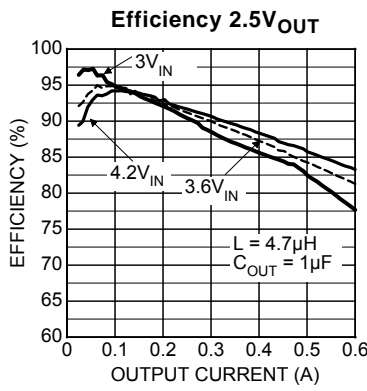
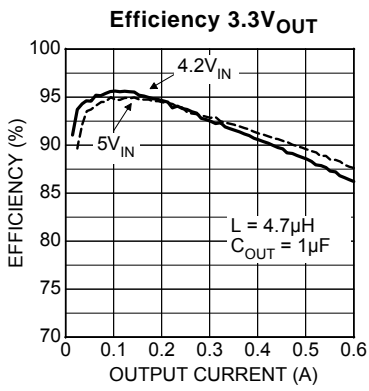
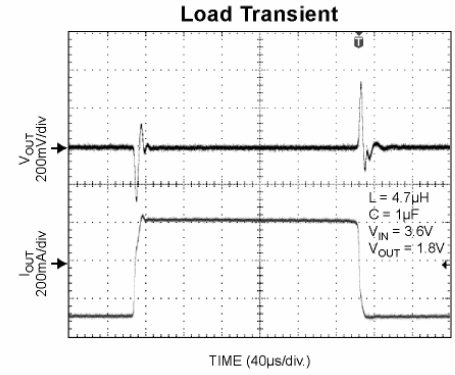
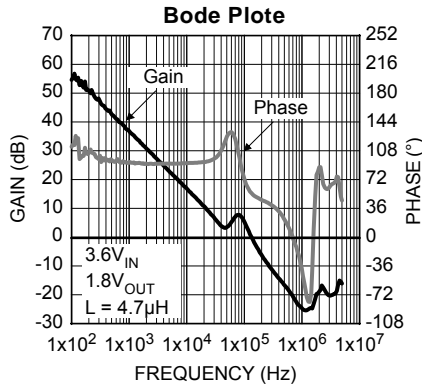
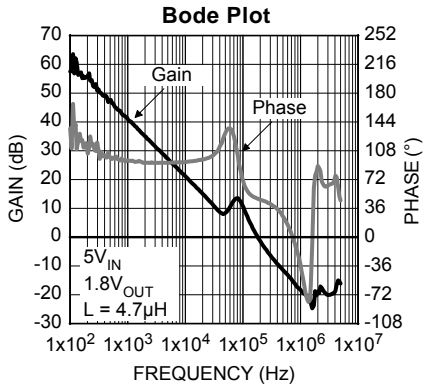

MIC2202BMM with 4.7µH Inductor and 1µF Output Capacitor

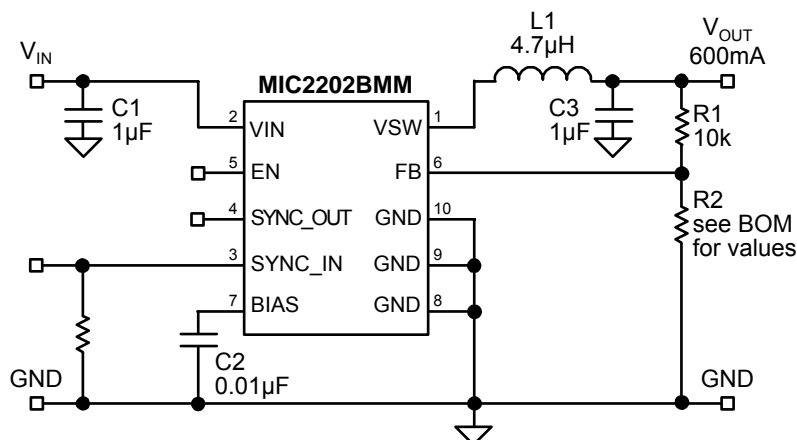

Figure 8. MIC2202BMM Schematic

Bill of Materials

Item	Part Number	Manufacturer	Description	Qty.
C1, C3	06036D105MAT2	AVX ⁽¹⁾	1µF Ceramic Capacitor X5R, 6.3V, Size 0603	2
	GRM185R60J105KE21D	Murata ⁽²⁾		
C2	0201ZD103MAT2	AVX ⁽¹⁾	10nF Ceramic Capacitor 6.3V, Size 0201	1
	GRM033R10J103KA01D	Murata ⁽²⁾	10nF Ceramic Capacitor 6.3V, Size 0202	
L1	LQH32CN4R7M53K	Murata ⁽²⁾	4.7µH Inductor 150mΩ (3.2mmx2.5mmx1.55mm)	1
	CDRH2D14-4R7	Sumida ⁽³⁾	4.7µH Inductor 169mΩ (3.2mmx3.2mmx1.55mm)	
R1	CRCW04021002F	Vishay-Dale ⁽⁴⁾	10kΩ 1%, Size 0402	1
R2	CRCW04021781F	Vishay-Dale ⁽⁴⁾	1.78kΩ 1%, Size 0402 For 3.3V _{OUT}	1
	CRCW04022491F		2.49kΩ 1%, Size 0402 For 2.5V _{OUT}	
	CRCW04023831F		3.83kΩ 1%, Size 0402 For 1.8V _{OUT}	
	CRCW04024991F		4.99kΩ 1%, Size 0402 For 1.5V _{OUT}	
	CRCW04027151F		7.15kΩ 1%, Size 0402 For 1.2V _{OUT}	
	CRCW04021002F		10kΩ 1%, Size 0402 For 1V _{OUT}	
	N/A		Open For 0.5V _{OUT}	
U1	MIC2202BMM	Micrel, Inc. ⁽⁵⁾	2MHz High Efficiency Synchronous Buck Regulator	1

Notes:

1. AVX: www.avx.com
2. Murata: www.murata.com
3. Sumida: www.sumida.com
4. Vishay-Dale: www.vishay.com
5. Micrel, Inc.: www.micrel.com

MIC2202BMM with 1 μ H Inductor and 4.7 μ F Output Capacitor

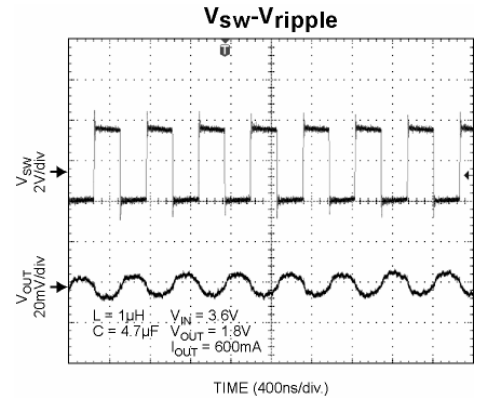
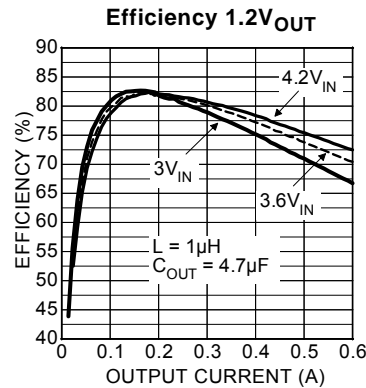
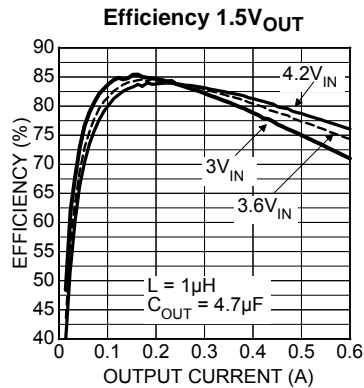
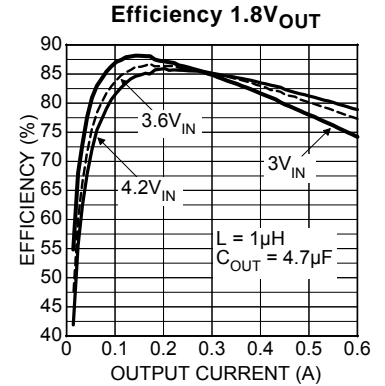
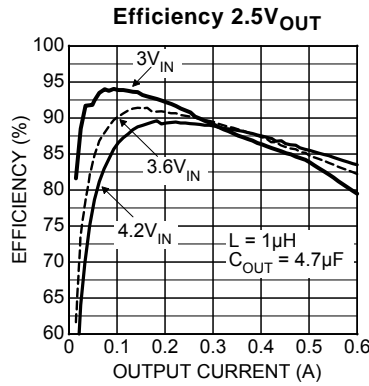
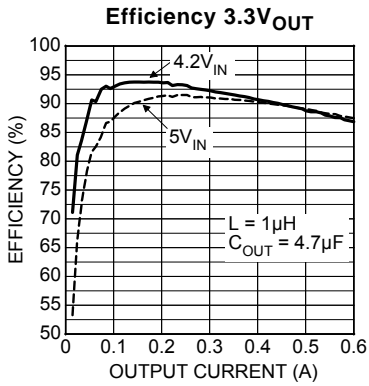
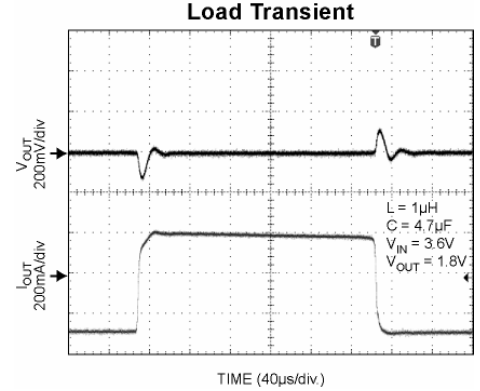
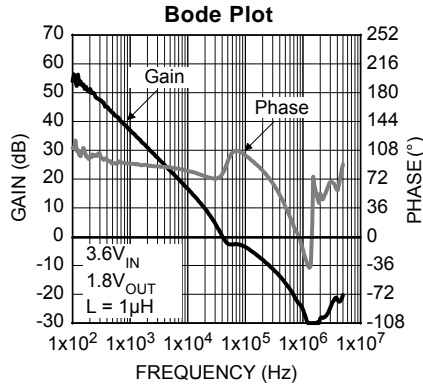
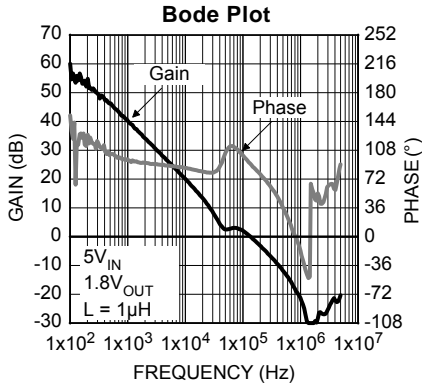

MIC2202BMM with 1μH Inductor and 4.7μF Output Capacitor

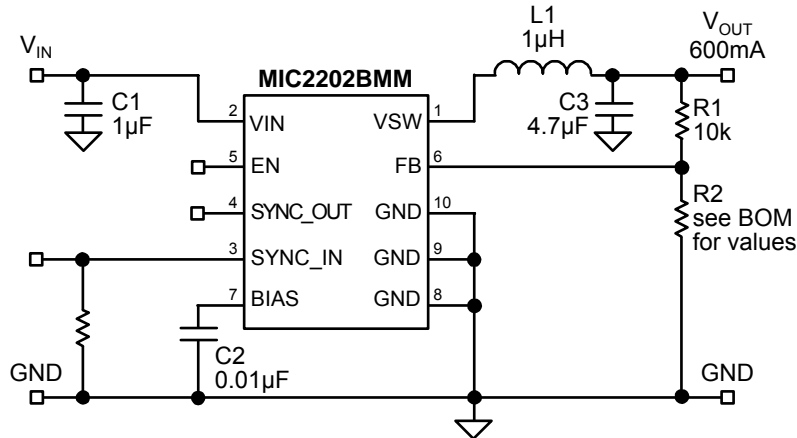

Figure 9. MIC2202BMM Schematic

Bill of Materials

Item	Part Number	Manufacturer	Description	Qty.
C1	06036D105MAT2	AVX ⁽¹⁾	1μF Ceramic Capacitor X5R, 6.3V, Size 0603	1
	GRM185R60J105KE21D	Murata ⁽²⁾		
C2	0201ZD103MAT2	AVX ⁽¹⁾	10nF Ceramic Capacitor 6.3V, Size 0201	1
	GRM033R10J103KA01D	Murata ⁽²⁾	10nF Ceramic Capacitor 6.3V, Size 0202	
C3	06036D475MAT2	AVX ⁽¹⁾	4.7μF Ceramic Capacitor 4V, Size 0201	1
	GRM033R10J103KA01D	Murata ⁽²⁾	4.7μF Ceramic Capacitor 6.3V, Size 0202	
L1	LQH32CN1R0M53K	Murata ⁽²⁾	1μH Inductor 60mΩ (3.2mmx2.5mmx1.55mm)	1
	CDRH2D14-1R5	Sumida ⁽³⁾	1.5μH Inductor 63mΩ (3.2mmx3.2mmx1.55mm)	
R1	CRCW04021002F	Vishay-Dale ⁽⁴⁾	10kΩ 1%, Size 0402	1
R2	CRCW04021781F	Vishay-Dale ⁽⁴⁾	1.78kΩ 1%, Size 0402 For 3.3V _{OUT}	1
	CRCW04022491F		2.49kΩ 1%, Size 0402 For 2.5V _{OUT}	
	CRCW04023831F		3.83kΩ 1%, Size 0402 For 1.8V _{OUT}	
	CRCW04024991F		4.99kΩ 1%, Size 0402 For 1.5V _{OUT}	
	CRCW04027151F		7.15kΩ 1%, Size 0402 For 1.2V _{OUT}	
	CRCW04021002F		10kΩ 1%, Size 0402 For 1V _{OUT}	
	N/A		Open For 0.5V _{OUT}	
U1	MIC2202BMM	Micrel, Inc. ⁽⁵⁾	2MHz High Efficiency Synchronous Buck Regulator	1

Notes:

1. AVX: www.avx.com
2. Murata: www.murata.com
3. Sumida: www.sumida.com
4. Vishay-Dale: www.vishay.com
5. Micrel, Inc.: www.micrel.com

Package Information

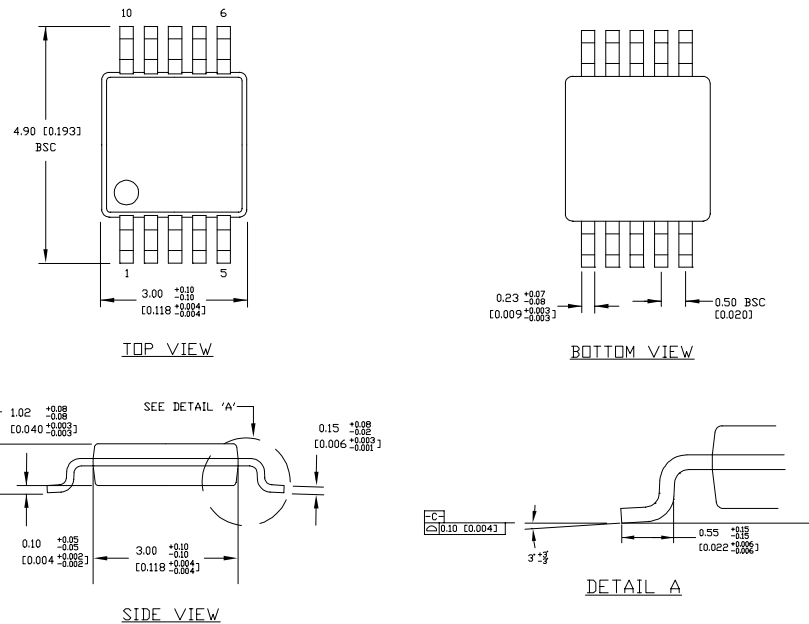

- NOTES:**
1. DIMENSIONS ARE IN MM [INCHES].
 2. CONTROLLING DIMENSION: MM
 3. DIMENSION DOES NOT INCLUDE MOLD FLASH OR PROTRUSIONS, EITHER OF WHICH SHALL NOT EXCEED 0.20 [0.008] PER SIDE.

10-Pin MSOP (MM)

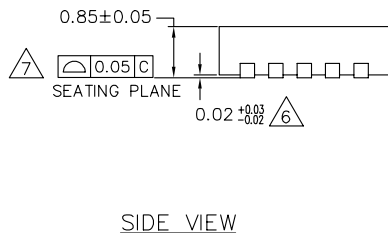
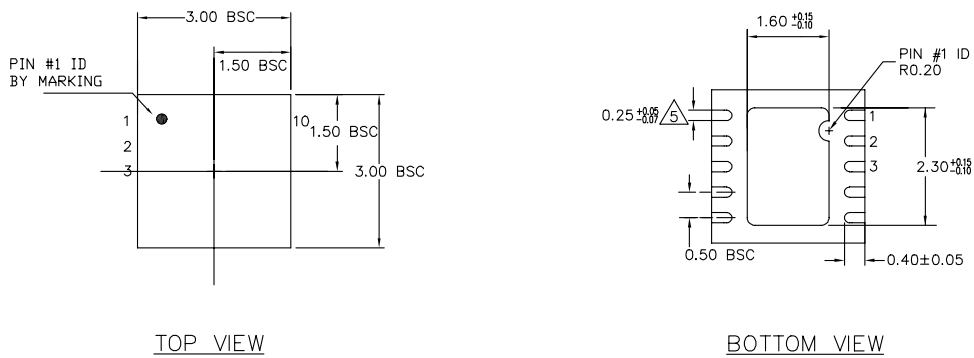

- NOTE:**
1. ALL DIMENSIONS ARE IN MILLIMETERS.
 2. MAX. PACKAGE WARPAGE IS 0.05 mm.
 3. MAXIMUM ALLOWABLE BURRS IS 0.076 mm IN ALL DIRECTIONS.
 4. PIN #1 ID ON TOP WILL BE LASER/INK MARKED.
 5. DIMENSION APPLIES TO METALIZED TERMINAL AND IS MEASURED BETWEEN 0.20 AND 0.25 mm FROM TERMINAL TIP.
 6. APPLIED ONLY FOR TERMINALS.
 7. APPLIED FOR EXPOSED PAD AND TERMINALS.

10-Pin MFL® (ML)

MICREL, INC. 2180 FORTUNE DRIVE SAN JOSE, CA 95131 USA
TEL +1 (408) 944-0800 FAX +1 (408) 474-1000 WEB <http://www.micrel.com>

The information furnished by Micrel in this data sheet is believed to be accurate and reliable. However, no responsibility is assumed by Micrel for its use. Micrel reserves the right to change circuitry and specifications at any time without notification to the customer.

Micrel Products are not designed or authorized for use as components in life support appliances, devices or systems where malfunction of a product can reasonably be expected to result in personal injury. Life support devices or systems are devices or systems that (a) are intended for surgical implant into the body or (b) support or sustain life, and whose failure to perform can be reasonably expected to result in a significant injury to the user. A Purchaser's use or sale of Micrel Products for use in life support appliances, devices or systems is a Purchaser's own risk and Purchaser agrees to fully indemnify Micrel for any damages resulting from such use or sale.

© 2004 Micrel, Incorporated.