

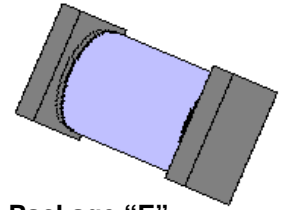
**VOIDLESS-HERMETICALLY-SEALED  
SURFACE MOUNT ULTRA FAST  
RECOVERY GLASS RECTIFIERS**

**DESCRIPTION**

This "Ultrafast Recovery" rectifier diode series is military qualified to MIL-PRF-19500/590 and is ideal for high-reliability applications where a failure cannot be tolerated. These industry-recognized 2.0 to 4.0 Amp rated rectifiers for working peak reverse voltages from 200 to 1000 volts are hermetically sealed with voidless-glass construction using an internal "Category I" metallurgical bond. These devices are also available in axial-leaded packages for thru-hole mounting (see separate data sheet for 1N6626 thru 1N6631). Microsemi also offers numerous other rectifier products to meet higher and lower current ratings with various recovery time speed requirements including standard, fast and ultrafast device types in both through-hole and surface mount packages.

**IMPORTANT:** For the most current data, consult MICROSEMI's website: <http://www.microsemi.com>

**APPEARANCE**



Package "E"  
or D-5B

**FEATURES**

- Surface mount series equivalent to the JEDEC registered 1N6626 to 1N6631 series
- Voidless hermetically sealed glass package
- Extremely robust construction
- Triple-layer passivation
- Internal "Category I" Metallurgical bonds
- JAN, JANTX, and JANTXV available per MIL-PRF-19500/590
- Further options for screening in accordance with MIL-PRF-19500 for JANS by using a "SP" prefix, e.g. SP6626US, SP6629US, etc.
- Axial-leaded equivalents also available (see separate data sheet for 1N6626 thru 1N6631)

**APPLICATIONS / BENEFITS**

- Ultrafast recovery rectifier series 200 to 1000 V
- Military and other high-reliability applications
- Switching power supplies or other applications requiring extremely fast switching & low forward loss
- High forward surge current capability
- Low thermal resistance
- Controlled avalanche with peak reverse power capability
- Inherently radiation hard as described in Microsemi MicroNote 050

**MAXIMUM RATINGS**

- Junction Temperature: -65°C to +150°C
- Storage Temperature: -65°C to +175°C
- Peak Forward Surge Current @ 25°C: 75A (except 1N6631 which is 60A)  
Note: Test pulse = 8.3ms, half-sine wave.
- Average Rectified Forward Current (I<sub>o</sub>) at T<sub>EC</sub> = +110°C:
 

1N6626US thru 1N6628US	2.3 A
1N6629US thru 1N6631US	1.8 A

 (Derate linearly at 2.5%/°C for T<sub>EC</sub> > +110°C)
- Average Rectified Forward Current (I<sub>o</sub>) at T<sub>A</sub> = 25°C:
 

1N6626US thru 1N6628US	1.75 A
1N6629US thru 1N6631US	1.40 A

 (Derate linearly at 0.80%/°C for T<sub>A</sub> > +25°C. This I<sub>o</sub> rating is for PC boards where thermal resistance from mounting point to ambient is sufficiently controlled where T<sub>J(max)</sub> is not exceeded. See latest issue of MIL-PRF-19500/590)
- Thermal Resistance junction to endcap (R<sub>θJEC</sub>): 6.5°C/W
- Capacitance at V<sub>R</sub> = 10 V: 40 pF
- Solder temperature: 260°C for 10 s (maximum)

**MECHANICAL AND PACKAGING**

- CASE: Hermetically sealed voidless hard glass with Tungsten slugs
- TERMINATIONS: End caps are Copper with Tin/Lead (Sn/Pb) finish. Note: Previous inventory had solid Silver end caps with Tin/Lead finish.
- MARKING: Cathode band only
- POLARITY: Cathode indicated by band
- Tape & Reel option: Standard per EIA-481-B
- Weight: 539 mg
- See package dimensions and recommended pad layout on last page

**ELECTRICAL CHARACTERISTICS @ 25°C**

TYPE NUMBER	MINIMUM BREAK-DOWN VOLTAGE $V_R$ $I_R = 50 \mu A$	MAXIMUM FORWARD VOLTAGE $V_F @ I_F$		WORKING PEAK REVERSE VOLTAGE $V_{RWM}$	MAXIMUM REVERSE CURRENT $I_R @ V_{RWM}$		MAXIMUM REVERSE RECOVERY TIME (LOW CURRENT) $t_{rr}$ Note 1	MAXIMUM REVERSE RECOVERY TIME (HIGH CURRENT) $t_{rr}$ Note 2	PEAK RECOVERY CURRENT $I_{RM} (rec)$ $I_F = 2 A$ , $100 A/\mu s$ Note 2	FORWARD RECOVERY VOLTAGE $V_{FRM} Max$ $I_F = 0.5 A$ $t_r = 12 ns$
		V @ A	V @ A		$T_A=25^\circ C$	$T_A=150^\circ C$				
1N6626US	220	1.35V @ 2.0 A	1.50V @ 4.0 A	200	2.0	500	30	45	3.5	8
1N6627US	440	1.35V @ 2.0 A	1.50V @ 4.0 A	400	2.0	500	30	45	3.5	8
1N6628US	660	1.35V @ 2.0 A	1.50V @ 4.0 A	600	2.0	500	30	45	3.5	8
1N6629US	880	1.40V @ 1.4 A	1.70V @ 3.0 A	800	2.0	500	50	60	4.2	12
1N6630US	990	1.40V @ 1.4 A	1.70V @ 3.0 A	900	2.0	500	50	60	4.2	12
1N6631US	1100	1.60V @ 1.4 A	1.95V @ 2.0 A	1000	4.0	600	60	80	5.0	20

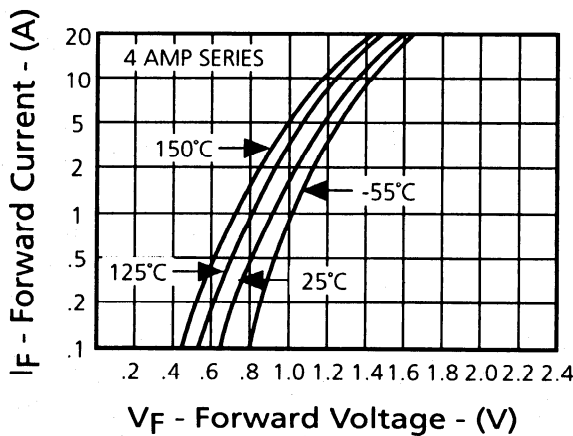
NOTE 1: Low Current Reverse Recovery Time Test Conditions:  $I_F=0.5A$ ,  $I_{RM}=1.0A$ ,  $I_{R(REC)} = 0.25A$  per MIL-STD-750, Method 4031, Condition B.

NOTE 2: High Current Reverse Recovery Time Test Conditions:  $I_F = 2 A$ ,  $100 A/\mu s$  MIL-STD-750, Method 4031, Condition D.

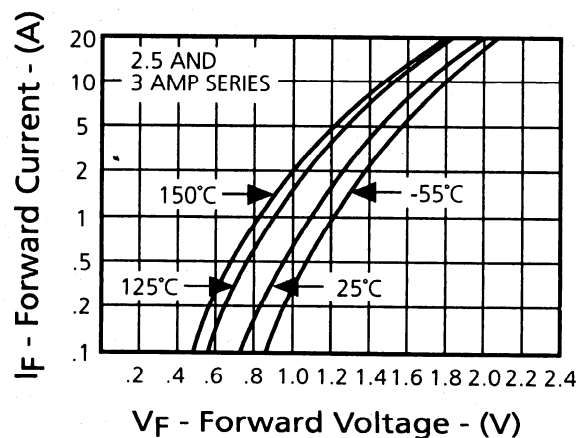
**SYMBOLS & DEFINITIONS**

Symbol	Definition
$V_{BR}$	Minimum Breakdown Voltage: The minimum voltage the device will exhibit at a specified current.
$V_{RWM}$	Working Peak Reverse Voltage: The maximum peak voltage that can be applied over the operating temperature range.
$V_F$	Maximum Forward Voltage: The maximum forward voltage the device will exhibit at a specified current.
$I_R$	Maximum Reverse Current: The maximum reverse (leakage) current that will flow at the specified voltage and temperature.
C	Capacitance: The capacitance in pF at a frequency of 1 MHz and specified voltage.
$t_{rr}$	Reverse Recovery Time: The time interval between the instant the current passes through zero when changing from the forward direction to the reverse direction and a specified recovery decay point after a peak reverse current is reached.

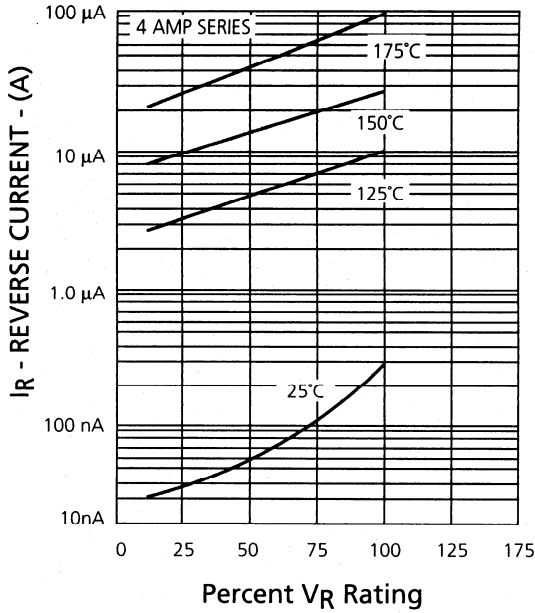
**CHARTS AND GRAPHS**



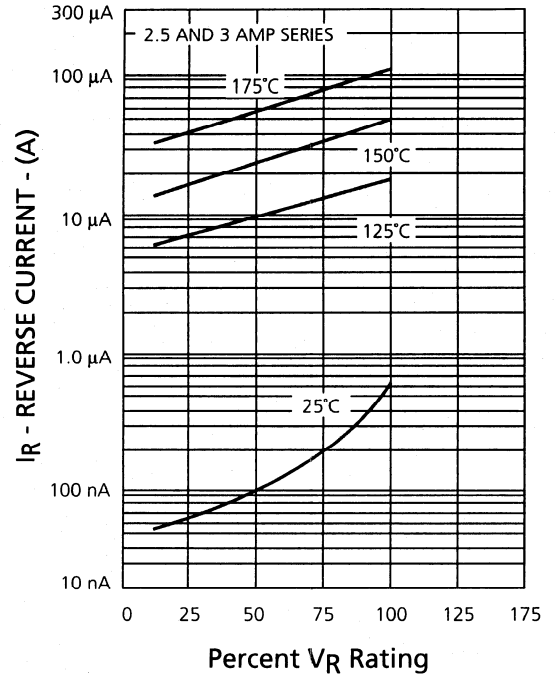
**FIGURE 1**  
Typical Forward Current  
vs  
Forward Voltage



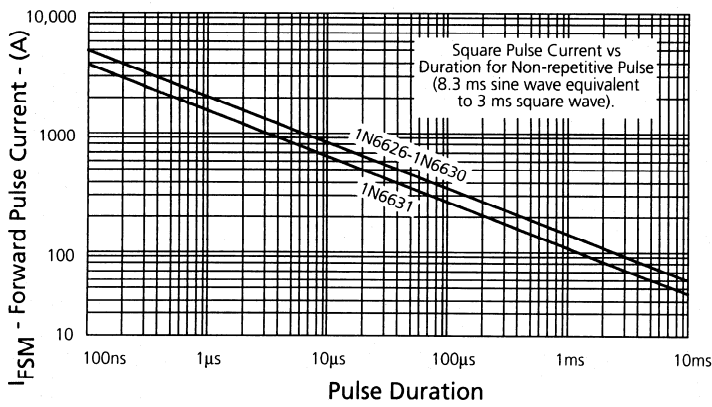
**FIGURE 2**  
Typical Forward Current  
vs  
Forward Voltage



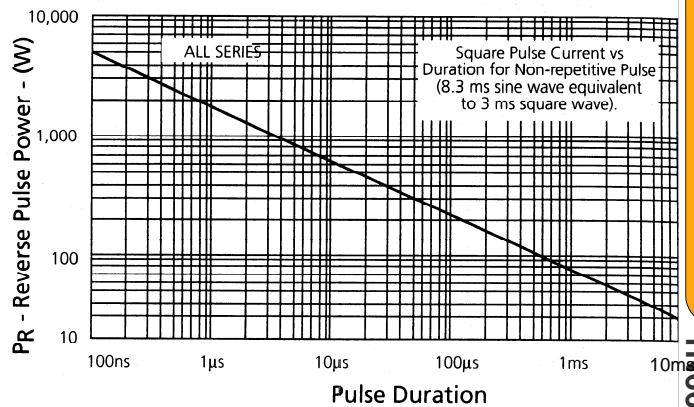
**FIGURE 3**  
Typical Reverse Current vs.  
Applied Reverse Voltage



**FIGURE 4**  
Typical Reverse Current vs.  
Applied Reverse Voltage

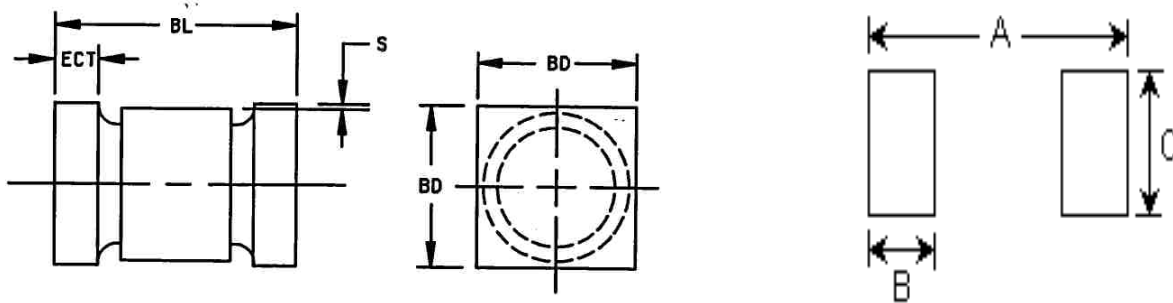


**FIGURE 5**  
Forward Pulse Current vs.  
Pulse Duration



**FIGURE 6**  
Reverse Pulse Power vs.  
Pulse Duration

PACKAGE DIMENSIONS AND PAD LAYOUT



NOTE: This Package Outline has also previously been identified as "D-5B"

	INCHES		mm	
	MIN	MAX	MIN	MAX
<b>BL</b>	.200	.225	5.08	5.72
<b>BD</b>	.137	.148	3.48	3.76
<b>ECT</b>	.019	.028	0.48	0.711
<b>S</b>	.003	---	0.08	---

PAD LAYOUT

	INCHES	mm
<b>A</b>	0.288	7.32
<b>B</b>	0.070	1.78
<b>C</b>	0.155	3.94

Note: If mounting requires adhesive separate from the solder, an additional 0.080 inch diameter contact may be placed in the center between the pads as an optional spot for cement.