Triple Half-bridge DMOS Output Driver with Serial Input Control

DATASHEET**Features**

- Supply voltage up to 40V
- $R_{DS(on)}$ typically 0.8 Ω at 25°C, Maximum 1.5 Ω at 150°C
- Up to 1.0A output current
- Three half-bridge outputs formed by three high-side and three low-side drivers
- Capable of switching all kinds of loads such as DC motors, bulbs, resistors, capacitors and inductors
- No shoot-through current
- Very low quiescent current $I_S < 2\mu A$ in Standby Mode versus total temperature range
- Outputs short-circuit protected
- Overtemperature protection for each switch and overtemperature prewarning
- Undervoltage protection
- Various diagnostic functions such as shorted output, open-load, overtemperature and power-supply fail detection
- Serial data interface, daisy chain capable, up to 2MHz clock frequency
- SO14 power package

2. Pin Configuration

Figure 2-1. Pinning SO14

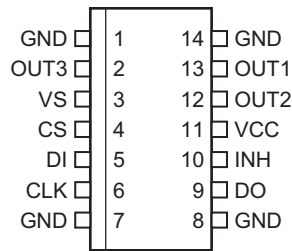

Table 2-1. Pin Description

Pin	Symbol	Function
1	GND	Ground; reference potential; internal connection to pin 7, 8 and 14; cooling tab
2	OUT3	Half-bridge output 3; formed by internally connected power MOS high-side switch 3 and low-side switch 3 with internal reverse diodes; short-circuit protection; overtemperature protection; diagnosis for short and open load
3	VS	Power supply for output stages OUT1, OUT2 and OUT3, internal supply
4	CS	Chip select input; 5V CMOS logic level input with internal pull up; low = serial communication is enabled, high = disabled
5	DI	Serial data input; 5V CMOS logic level input with internal pull down; receives serial data from the control device; DI expects a 16-bit control word with LSB being transferred first
6	CLK	Serial clock input; 5V CMOS logic level input with internal pull down; controls serial data input interface and internal shift register ($f_{max} = 2\text{MHz}$)
7	GND	Ground; see pin 1
8	GND	Ground; see pin 1
9	DO	Serial data output; 5V CMOS logic level tristate output for output (status) register data; sends 16-bit status information to the microcontroller (LSB is transferred first); output will remain tri-stated unless device is selected by CS = low, therefore, several ICs can operate on only one data output line.
10	INH	Inhibit input; 5V logic input with internal pull down; low = standby, high = normal operation
11	VCC	Logic supply voltage (5V)
12	OUT2	Half-bridge output 2; see pin 2
13	OUT1	Half-bridge output 1; see pin 2
14	GND	Ground; see pin 1

3. Functional Description

3.1 Serial Interface

Data transfer starts with the falling edge of the CS signal. Data must appear at DI synchronized to CLK and is accepted on the falling edge of the CLK signal. LSB (bit 0, SRR) has to be transferred first. Execution of new input data is enabled on the rising edge of the CS signal. When CS is high, pin DO is in tri-state condition. This output is enabled on the falling edge of CS. Output data will change their state with the rising edge of CLK and stay stable until the next rising edge of CLK appears. LSB (bit 0, TP) is transferred first.

Figure 3-1. Data Transfer

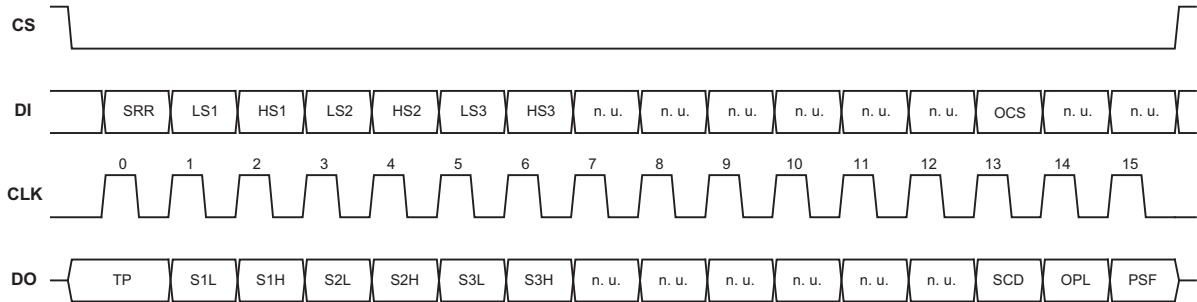

Table 3-1. Input Data Protocol

Bit	Input Register	Function
0	SRR	Status register reset (high = reset; the bits PSF, OPL and SCD in the output data register are set to low)
1	LS1	Controls output LS1 (high = switch output LS1 on)
2	HS1	Controls output HS1 (high = switch output HS1 on)
3	LS2	See LS1
4	HS2	See HS1
5	LS3	See LS1
6	HS3	See HS1
7	n. u.	Not used
8	n. u.	Not used
9	n. u.	Not used
10	n. u.	Not used
11	n. u.	Not used
12	n. u.	Not used
13	OCS	Overcurrent shutdown (high = overcurrent shutdown is active)
14	n. u.	Not used
15	n. u.	Not used

Table 3-2. Output Data Protocol

Bit	Output (Status) Register	Function
0	TP	Temperature prewarning: high = warning
1	Status LS1	High = output is on, low = output is off; not affected by SRR
2	Status HS1	High = output is on, low = output is off; not affected by SRR
3	Status LS2	Description see LS1
4	Status HS2	Description see HS1
5	Status LS3	Description see LS1
6	Status HS3	Description see HS1
7	n. u.	Not used
8	n. u.	Not used
9	n. u.	Not used
10	n. u.	Not used
11	n. u.	Not used
12	n. u.	Not used
13	SCD	Short circuit detected: set high when at least one high-side or low-side switch is switched off by a short-circuit condition. Bits 1 to 6 can be used to detect the shorted switch.
14	OPL	Open load detected: set high, when at least one active high-side or low-side switch sinks/sources a current below the open load threshold current.
15	PSF	Power-supply fail: undervoltage at pin VS detected

After power-on reset, the input register has the following status:

Bit 15	Bit 14	Bit 13 (OCS)	Bit 12	Bit 11	Bit 10	Bit 9	Bit 8	Bit 7	Bit 6 (HS3)	Bit 5 (LS3)	Bit 4 (HS2)	Bit 3 (LS2)	Bit 2 (HS1)	Bit 1 (LS1)	Bit 0 (SRR)
x	x	H	x	x	x	x	x	x	L	L	L	L	L	L	L

The following patterns are used to enable internal test modes of the IC. It is not recommended to use these patterns during normal operation.

Bit 15	Bit 14	Bit 13 (OCS)	Bit 12	Bit 11	Bit 10	Bit 9	Bit 8	Bit 7	Bit 6 (HS3)	Bit 5 (LS3)	Bit 4 (HS2)	Bit 3 (LS2)	Bit 2 (HS1)	Bit 1 (LS1)	Bit 0 (SRR)
H	H	H	H	H	L	L	L	L	L	L	L	L	L	L	L
H	H	H	L	L	H	H	L	L	L	L	L	L	L	L	L
H	H	H	L	L	L	L	H	H	L	L	L	L	L	L	L

3.2 Power-supply Fail

In case of undervoltage at pin VS, the Power-Supply Fail bit (PSF) in the output register is set and all outputs are disabled. To detect an undervoltage, its duration has to be longer than the undervoltage detection delay time t_{dUV} . The outputs are enabled immediately when supply voltage recovers to a normal operating value. The PSF bit stays high until it is reset by the SRR (Status Register Reset) bit in the input register.

3.3 Open-load Detection

If the current through a high-side or low-side switch in the ON-state stays below the open-load detection threshold, the open-load detection bit (OPL) in the output register is set.

The OPL bit stays high until it is reset by the SRR bit in the input register. To detect an open load, its duration has to be longer than the open-load detection delay time t_{dOL} .

3.4 Overtemperature Protection

If the junction temperature of one or more output stages exceeds the thermal prewarning threshold, $T_{jPW\ set}$, the temperature prewarning bit (TP) in the output register is set. When the temperature falls below the thermal prewarning threshold, $T_{jPW\ reset}$, the bit TP is reset. The TP bit can be read without transferring a complete 16-bit data word. The status of TP is available at pin DO with the falling edge of CS. After the microcontroller has read this information, CS is set high and the data transfer is interrupted without affecting the status of input and output registers.

If the junction temperature of one or more output stages exceeds the thermal shutdown threshold, $T_{j\ switch\ off}$, all outputs are disabled and the corresponding bits in the output register are set to low. The outputs can be enabled again when the temperature falls below the thermal shutdown threshold, $T_{j\ switch\ on}$ and the SRR bit in the input register is set to high. Hysteresis of thermal pre-warning and shutdown threshold avoids oscillations.

3.5 Short-circuit Protection

The output currents are limited by a current regulator. Overcurrent detection is activated by writing a high to the OCS (Overcurrent Shutdown) bit in the input register. When the current in an output stage exceeds the overcurrent limitation and shutdown threshold, it is switched off after a delay time (t_{dSD}). The short-circuit detection bit (SCD) is set and the corresponding status bit in the output register is set to low. For OCS = low the overcurrent shutdown is inactive. The SCD bit is also set if the current exceeds the overcurrent limitation and shutdown threshold, but the outputs are not affected. By writing a high to the SRR bit in the input register the SCD bit is reset and the disabled outputs are enabled.

3.6 Inhibit

Applying 0V to pin 10 (INH) inhibits the Atmel® ATA6826C.

All output switches are then turned off and switched to tri-state. The data in the output register is deleted. The current consumption is reduced to less than 2µA at pin VS and less than 25µA at pin VCC. The output switches can be activated again by switching pin 10 (INH) to 5V which initiates an internal power-on reset.

4. Absolute Maximum Ratings

Stresses beyond those listed under “Absolute Maximum Ratings” may cause permanent damage to the device. This is a stress rating only and functional operation of the device at these or any other conditions beyond those indicated in the operational sections of this specification is not implied. Exposure to absolute maximum rating conditions for extended periods may affect device reliability.

All values refer to GND pins.

Parameters	Pin	Symbol	Value	Unit
Supply voltage	3	V_{VS}	-0.3 to +40	V
Supply voltage $t < 0.5s$; $I_S > -2A$	3	V_{VS}	-1	V
Logic supply voltage	11	V_{VCC}	-0.3 to +7	V
Logic input voltage	4 to 6, 10	$V_{CS}, V_{DI}, V_{CLK}, V_{INH}$	-0.3 to $V_{VCC} + 0.3$	V
Logic output voltage	9	V_{DO}	-0.3 to $V_{VCC} + 0.3$	V
Input current	4 to 6, 10	$I_{CS}, I_{DI}, I_{CLK}, I_{INH}$	-10 to +10	mA
Output current	9	I_{DO}	-10 to +10	mA
Output current	2, 12 and 13	$I_{Out3}, I_{Out2}, I_{Out1}$	Internally limited, see output specification	
Output voltage	2, 12 and 13	$I_{Out3}, I_{Out2}, I_{Out1}$	-0.3 to +40	V
Reverse conducting current ($t_{pulse} = 150\mu s$)	2, 12 and 13 towards pin 3	$I_{Out3}, I_{Out2}, I_{Out1}$	17	A
Junction temperature range		T_J	-40 to +150	°C
Storage temperature range		T_{STG}	-55 to +150	°C

5. Thermal Resistance

Parameters	Test Conditions	Symbol	Value	Unit
Junction pin	Measured to GND Pins 1, 7, 8 and 14	R_{thJP}	30	K/W
Junction ambient		R_{thJA}	65	K/W

6. Operating Range

Parameters	Symbol	Value	Unit
Supply voltage	V_{VS}	$V_{UV}^{(1)}$ to 40	V
Logic supply voltage	V_{VCC}	4.75 to 5.25	V
Logic input voltage	$V_{CS}, V_{DI}, V_{CLK}, V_{INH}$	-0.3 to V_{VCC}	V
Serial interface clock frequency	f_{CLK}	2	MHz
Junction temperature range	T_J	-40 to +150	°C

Note: ⁽¹⁾ Threshold for undervoltage detection

7. Noise and Surge Immunity

Parameters	Test Conditions	Value
Conducted interferences	ISO 7637-1	Level 4 ⁽¹⁾
Interference suppression	VDE 0879 Part 2	Level 5
ESD (human body model); pins 2, 12, 13 vs. GND	HBM: AEC-Q100-002-Ref-D CEI/IEC 60749-26:2006	8kV
ESD (human body model), all other pins	ESDA/JEDEC JS-001-2010	5kV
CDM (charged device model)	ANSI/ESD S5.3.1-2009	1kV
MM (machine model)	AEC Q100-003-REV-E ANSI/ESD S5.2-2009	250V

Note: Test pulse 5: $V_{smax} = 40V$

8. Electrical Characteristics

$7.5V < V_{VS} < 40V$; $4.75V < V_{VCC} < 5.25V$; INH = High; $-40^{\circ}C < T_j < 150^{\circ}C$; unless otherwise specified, all values refer to GND pins.

No.	Parameters	Test Conditions	Pin	Symbol	Min.	Typ.	Max.	Unit	Type*
1	Current Consumption								
1.1	Quiescent current VS	$V_{VS} < 20V$, INH = low	3	I_{VS}		1	2	μA	A
1.2	Quiescent current VCC	$4.75V < V_{VCC} < 5.25V$, INH = low	11	I_{VCC}		15	25	μA	A
1.3	Supply current VS	$V_{VS} < 20V$ normal operating, all outputs off	3	I_{VS}		4	6	mA	A
1.4	Supply current VCC	$4.75V < V_{VCC} < 5.25V$, normal operating	11	I_{VCC}		350	500	μA	A
1.5	Discharge current VS	$V_{VS} = 32.5V$, INH = low	3	I_{VS}	0.5		5.5	mA	A
1.6	Discharge current VS	$V_{VS} = 40V$, INH = low	3	I_{VS}	2.5		10	mA	A
2	Undervoltage Detection, Power-on Reset								
2.1	Power-on reset threshold		11	V_{VCC}	3.2	3.9	4.4	V	A
2.2	Power-on reset delay time	After switching on V_{CC}		t_{dPor}	30	95	190	μs	A
2.3a	Undervoltage-detection threshold (down)	$V_{CC} = 5V$	3	V_{UV}	5.6		6.5	V	A
2.3b	Undervoltage-detection threshold (up)	$V_{CC} = 5V$	3	V_{UV}	6.0		7.0	V	A
2.4	Undervoltage-detection hysteresis	$V_{CC} = 5V$	3	ΔV_{UV}		0.6		V	A
2.5	Undervoltage-detection delay time			t_{dUV}	10		40	μs	A

*) Type means: A = 100% tested, B = 100% correlation tested, C = Characterized on samples, D = Design parameter

Note: 1. Delay time between rising edge of the input signal at pin CS after data transmission and switch on output stages to 90% of final level. Device not in standby for $t > 1ms$

8. Electrical Characteristics (Continued)

7.5V < V_{VS} < 40V; 4.75V < V_{VCC} < 5.25V; INH = High; -40°C < T_j < 150°C; unless otherwise specified, all values refer to GND pins.

No.	Parameters	Test Conditions	Pin	Symbol	Min.	Typ.	Max.	Unit	Type*
3 Thermal Prewarning and Shutdown									
3.1	Thermal prewarning set			T _{jPW set}	120	145	170	°C	B
3.2	Thermal prewarning reset			T _{jPW reset}	105	130	155	°C	B
3.3	Thermal prewarning hysteresis			ΔT _{jPW}		15		°C	B
3.4	Thermal shutdown off			T _{j switch off}	150	175	200	°C	B
3.5	Thermal shutdown on			T _{j switch on}	135	160	185	°C	B
3.6	Thermal shutdown hysteresis			ΔT _{j switch off}		15		K	B
3.7	Ratio thermal shutdown off/thermal prewarning set			$\frac{T_{j \text{ switch off}}}{T_{jPW \text{ set}}}$	1.05	1.2			B
3.8	Ratio thermal shutdown on/thermal prewarning reset			$\frac{T_{j \text{ switch on}}}{T_{jPW \text{ reset}}}$	1.05	1.2			B
4 Output Specification (OUT1-OUT3)									
4.1	On resistance	I _{Out 1-3} = -0.9A	2, 12, 13	R _{DSOn1-3}		0.8	1.5	Ω	A
4.2		I _{Out 1-3} = +0.9A	2, 12, 13	R _{DSOn1-3}		0.8	1.5	Ω	A
4.3	High-side output leakage current	V _{Out 1-3} = 0V, output stages off	2, 12, 13	I _{Out1-3}	-15			μA	A
4.4	Low-side output leakage current	V _{Out 1-3} = V _{VS} , output stages off	2, 12, 13	I _{Out1-3}			200	μA	A
4.5	High-side switch reverse diode forward voltage	I _{Out 1-3} = 1.5A	2, 12, 13	V _{Out1-3} - V _{VS}			2	V	A
4.6	Low-side switch reverse diode forward voltage	I _{Out 1-3} = -1.5A	2, 12, 13	V _{Out 1-3}	-2			V	A
4.7	High-side overcurrent limitation and shutdown threshold	7.5V < V _S < 20V 20V ≤ V _S < 40V	2, 12, 13	I _{Out1-3}	-1.7 -2.0	-1.3 -1.3	-1.0 -1.0	A A	A
4.8	Low-side overcurrent limitation and shutdown threshold	7.5V < V _S < 20V 20V ≤ V _S < 40V	2, 12, 13	I _{Out1-3}	1 1	1.3 1.3	1.7 2.0	A A	A
4.9	Overcurrent shutdown delay time			t _{dSd}	10		40	μs	A
4.10	High-side open-load detection threshold		2, 12, 13	I _{Out1-3}	-50	-30	-10	mA	A
4.11	Low-side open-load detection threshold		2, 12, 13	I _{Out1-3}	10	30	50	mA	A

*) Type means: A = 100% tested, B = 100% correlation tested, C = Characterized on samples, D = Design parameter

Note: 1. Delay time between rising edge of the input signal at pin CS after data transmission and switch on output stages to 90% of final level. Device not in standby for t > 1ms

8. Electrical Characteristics (Continued)

7.5V < V_{VS} < 40V; 4.75V < V_{VCC} < 5.25V; INH = High; -40°C < T_j < 150°C; unless otherwise specified, all values refer to GND pins.

No.	Parameters	Test Conditions	Pin	Symbol	Min.	Typ.	Max.	Unit	Type*
4.12	Open-load detection delay time			t _{dOL}	200		600	μs	A
4.13	High-side output switch on delay ⁽¹⁾	V _{VS} = 13V R _{Load} = 30Ω		t _{don}			20	μs	A
4.14	Low-side output switch on delay ⁽¹⁾	V _{VS} = 13V R _{Load} = 30Ω		t _{don}			20	μs	A
4.15	High-side output switch off delay ⁽¹⁾	V _{VS} = 13V R _{Load} = 30Ω		t _{doff}			20	μs	A
4.16	Low-side output switch off delay ⁽¹⁾	V _{VS} = 13V R _{Load} = 30Ω		t _{doff}			3	μs	A
4.17	Dead time between corresponding high- and low-side switches	V _{VS} = 13V R _{Load} = 30Ω		t _{don} - t _{doff}	1			μs	A
5 Logic Inputs DI, CLK, CS, INH									
5.1	Input voltage low-level threshold		4-6, 10	V _{IL}	0.3 × V _{VCC}			V	A
5.2	Input voltage high-level threshold		4-6, 10	V _{IH}			0.7 × V _{VCC}	V	A
5.3	Hysteresis of input voltage		4-6, 10	ΔV _I	50		700	mV	B
5.4	Pull-down current pin DI, CLK, INH	V _{DI} , V _{CLK} , V _{INH} = V _{CC}	5, 6, 10	I _{PD}	10		65	μA	A
5.5	Pull-up current pin CS	V _{CS} = 0V	4	I _{PU}	-65		-10	μA	A
6 Serial Interface – Logic Output DO									
6.1	Output-voltage low level	I _{DOL} = 2mA	9	V _{DOL}			0.4	V	A
6.2	Output-voltage high level	I _{DOL} = -2mA	9	V _{DOH}	V _{VCC} - 0.7V			V	A
6.3	Leakage current (tri-state)	V _{CS} = V _{CC} 0V < V _{DO} < V _{VCC}	9	I _{DO}	-10		10	μA	A
7 Inhibit Input - Timing									
7.1	Delay time from standby to normal operation			t _{dINH}			100	μs	A

*) Type means: A = 100% tested, B = 100% correlation tested, C = Characterized on samples, D = Design parameter

Note: 1. Delay time between rising edge of the input signal at pin CS after data transmission and switch on output stages to 90% of final level. Device not in standby for t > 1ms

9. Serial Interface – Timing

No.	Parameters	Test Conditions	Pin	Timing Chart No. ⁽¹⁾	Symbol	Min.	Typ.	Max.	Unit	Type*
8.1	DO enable after CS falling edge	C _{DO} = 100pF	9	1	t _{ENDO}			200	ns	D
8.2	DO disable after CS rising edge	C _{DO} = 100pF	9	2	t _{DISDO}			200	ns	D
8.3	DO fall time	C _{DO} = 100pF	9	-	t _{DOF}			100	ns	D
8.4	DO rise time	C _{DO} = 100pF	9	-	t _{DOR}			100	ns	D
8.5	DO valid time	C _{DO} = 100pF	9	10	t _{DOVal}			200	ns	D
8.6	CS setup time		4	4	t _{CSsethl}	225			ns	D
8.7	CS setup time		4	8	t _{CSseth}	225			ns	D
8.8	CS high time		4	9	t _{CSH}	500			ns	D
8.9	CLK high time		6	5	t _{CLKh}	225			ns	D
8.10	CLK low time		6	6	t _{CLKl}	225			ns	D
8.11	CLK period time		6	-	t _{CLKp}	500			ns	D
8.12	CLK setup time		6	7	t _{CLKsethl}	225			ns	D
8.13	CLK setup time		6	3	t _{CLKseth}	225			ns	D
8.14	DI setup time		5	11	t _{DIset}	40			ns	D
8.15	DI hold time		5	12	t _{DIHold}	40			ns	D

*) Type means: A = 100% tested, B = 100% correlation tested, C = Characterized on samples, D = Design parameter

Note: 1. See [Figure 9-1 on page 12](#) “Serial Interface Timing with Chart Numbers”

Figure 9-1. Serial Interface Timing with Chart Numbers

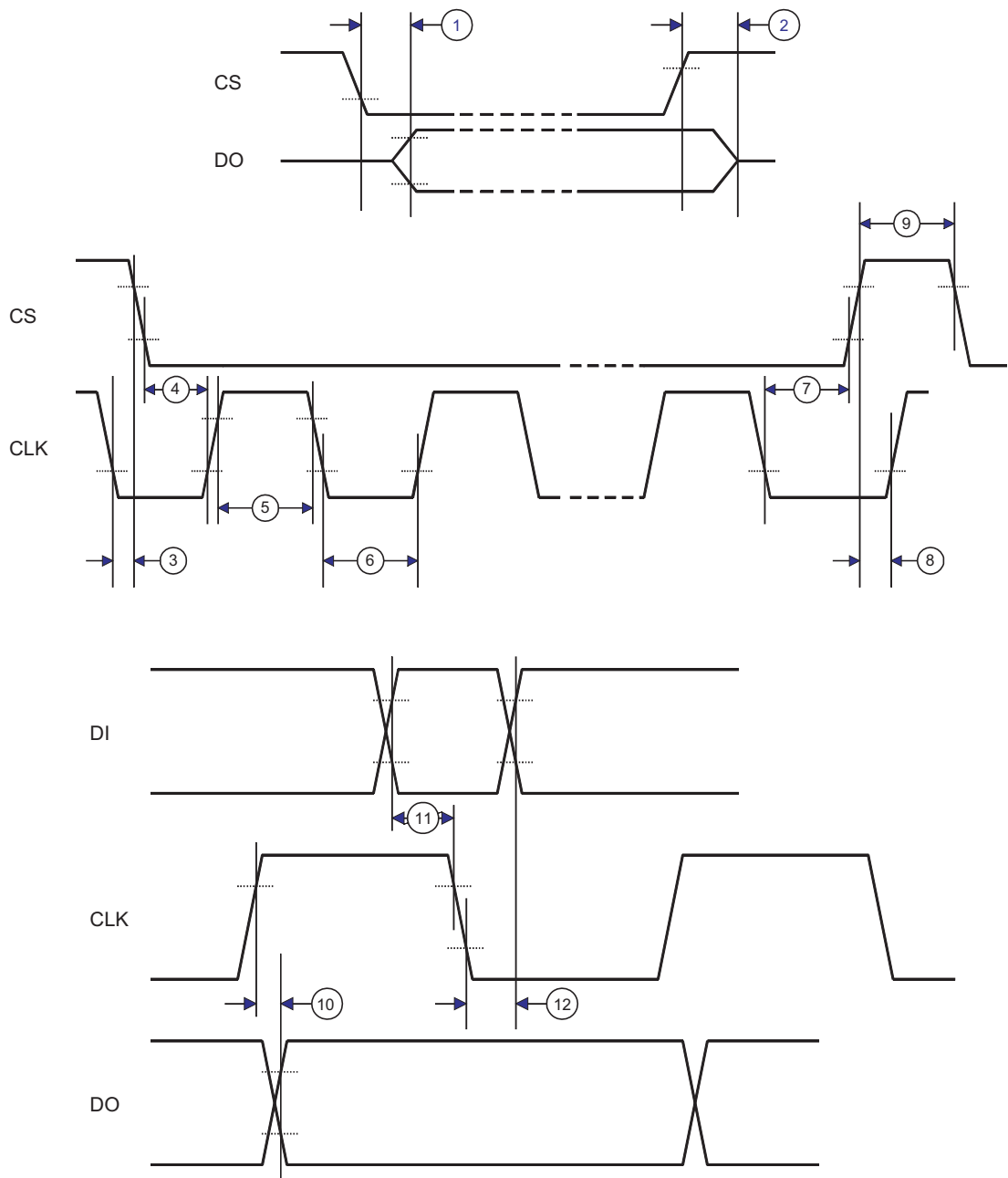

Inputs DI, CLK, CS: High level = $0.7 \times V_{CC}$, low level = $0.3 \times V_{CC}$
 Output DO: High level = $0.8 \times V_{CC}$, low level = $0.2 \times V_{CC}$

12. Ordering Information

Extended Type Number	Package	Remarks
ATA6826C-TUQW	SO14	Power package, taped and reeled, 4k, green

13. Package Information

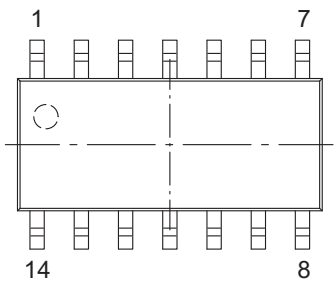
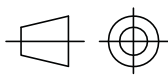
technical drawings according to DIN specifications

Dimensions in mm

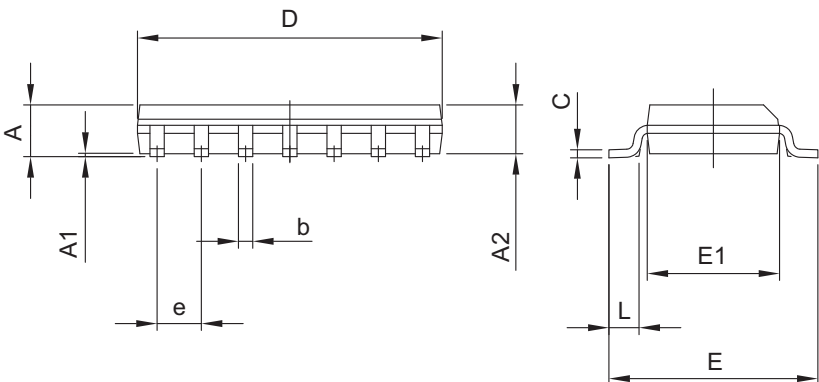

Note¹⁾: Dimensions "D" and "E1" do not include Moldflash or protrusion. (MAX. 0.15mm per side)

Bemerkung: ASE

COMMON DIMENSIONS (Unit of Measure = mm)			
Symbol	MIN	NOM	MAX
A	1.35	1.55	1.75
A1	0.10	0.18	0.25
A2	1.25	1.38	1.50
b	0.33	0.42	0.51
C	0.19	0.22	0.25
D ¹⁾	8.55	8.65	8.75
E ¹⁾	3.80	3.90	4.00
E	5.80	6.00	6.20
e		1.27 BSC	
L	0.40	0.84	1.27

04/13/12

 Package Drawing Contact: packagedrawings@atmel.com	TITLE	GPC	DRAWING NO.	REV.
	Package: SO14		6.541-5053.01-4	1

14. Revision History

Please note that the following page numbers referred to in this section refer to the specific revision mentioned, not to this document.

Revision No.	History
9213F-AUTO-08/15	• Section 12 “Ordering Information” on page 14 updated
9213E-AUTO-06/14	• Put datasheet in the latest template
9213D-AUTO-09/12	• Section 7 “Noise and Surge Immunity” on page 8 changed
9213C-AUTO-05/12	• Section 13 “Package Information” on page 14 changed
9213B-BCD-01/11	• Section 3.6 “Inhibit” on page 6 changed



Atmel Corporation 1600 Technology Drive, San Jose, CA 95110 USA T: (+1)(408) 441.0311 F: (+1)(408) 436.4200 | www.atmel.com

© 2015 Atmel Corporation. / Rev.: 9213F-AUTO-08/15

Atmel®, Atmel logo and combinations thereof, Enabling Unlimited Possibilities®, and others are registered trademarks or trademarks of Atmel Corporation in U.S. and other countries. Other terms and product names may be trademarks of others.

DISCLAIMER: The information in this document is provided in connection with Atmel products. No license, express or implied, by estoppel or otherwise, to any intellectual property right is granted by this document or in connection with the sale of Atmel products. EXCEPT AS SET FORTH IN THE ATMEL TERMS AND CONDITIONS OF SALES LOCATED ON THE ATMEL WEBSITE, ATMEL ASSUMES NO LIABILITY WHATSOEVER AND DISCLAIMS ANY EXPRESS, IMPLIED OR STATUTORY WARRANTY RELATING TO ITS PRODUCTS INCLUDING, BUT NOT LIMITED TO, THE IMPLIED WARRANTY OF MERCHANTABILITY, FITNESS FOR A PARTICULAR PURPOSE, OR NON-INFRINGEMENT. IN NO EVENT SHALL ATMEL BE LIABLE FOR ANY DIRECT, INDIRECT, CONSEQUENTIAL, PUNITIVE, SPECIAL OR INCIDENTAL DAMAGES (INCLUDING, WITHOUT LIMITATION, DAMAGES FOR LOSS AND PROFITS, BUSINESS INTERRUPTION, OR LOSS OF INFORMATION) ARISING OUT OF THE USE OR INABILITY TO USE THIS DOCUMENT, EVEN IF ATMEL HAS BEEN ADVISED OF THE POSSIBILITY OF SUCH DAMAGES. Atmel makes no representations or warranties with respect to the accuracy or completeness of the contents of this document and reserves the right to make changes to specifications and products descriptions at any time without notice. Atmel does not make any commitment to update the information contained herein. Unless specifically provided otherwise, Atmel products are not suitable for, and shall not be used in, automotive applications. Atmel products are not intended, authorized, or warranted for use as components in applications intended to support or sustain life.

SAFETY-CRITICAL, MILITARY, AND AUTOMOTIVE APPLICATIONS DISCLAIMER: Atmel products are not designed for and will not be used in connection with any applications where the failure of such products would reasonably be expected to result in significant personal injury or death ("Safety-Critical Applications") without an Atmel officer's specific written consent. Safety-Critical Applications include, without limitation, life support devices and systems, equipment or systems for the operation of nuclear facilities and weapons systems. Atmel products are not designed nor intended for use in military or aerospace applications or environments unless specifically designated by Atmel as military-grade. Atmel products are not designed nor intended for use in automotive applications unless specifically designated by Atmel as automotive-grade.