

DESCRIPTION

DESCRIPTION (300 watt)

This 3 pin TRANSIENT VOLTAGE SUPPRESSOR offers 2 unidirectional or 1 bidirectional protection at the board level from voltage transients caused by electrostatic discharge (ESD) as defined by IEC 61000-4-2, electrical fast transients (EFT) per IEC 61000-4-4.

Unidirectional protection can be accomplished by connecting the Input/Output lines to pins 1 and 2 and pin 3 to common ground. In a bidirectional configuration pin 1 or pin 2 is connected to common or ground. Pin 3 is not connected. The SM03 thru SM36 product provides board level protection from static electricity and other induced voltage surges that can damage sensitive circuitry.

These TRANSIENT VOLTAGE SUPPRESSOR (TVS) Diode Arrays protect 3.0/3.3 volt components such as DRAM's, SRAM's, CMOS, HCMOS, HSIC, and low voltage interfaces up to 36 Volts. Because of the physical size, weight and protection capabilities, this product is ideal for use in but not limited to miniaturized electronic equipment such as hand held instruments, computers, computer peripherals and cell phones. RoHS Compliant devices also available be adding an e3 suffix.

TVSarray™ SERIES

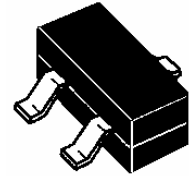

APPLICATIONS

- EIA-RS232 data rate 19.6kbs
- EIA-RS422 data rate 10Mbps
- EIA-RS423 data rate 100kbs

IMPORTANT: For the most current data, consult MICROSEMI's website: <http://www.microsemi.com>

FEATURES

- Protects 3.0/3.3 up through 36V components
- Protects 2 unidirectional or 1 bidirectional line
- Provides electrically isolated protection
- RoHS Compliant devices available by adding e3 suffix

PACKAGING

- Tape & Reel per EIA Standard 481
- 7 inch reel 3,000 pieces (STANDARD)

MAXIMUM RATINGS

- Operating Temperature: -55°C to +150°C
- Storage Temperature: -55°C to +150°C
- Peak Pulse power 300 watts (8/20 μs Figure 1)
- Pulse Repetition Rate: < .01%

MECHANICAL

- CASE: Molded epoxy SOT-23 (meets UL94V-0)
- FINISH: Tin-Lead or RoHS Compliant annealed matte-Tin plating readily solderably per MIL-STD-750 method 2026
- WEIGHT: 0.014 grams (approximate)
- MARKING: See marking code below

ELECTRICAL CHARACTERISTICS PER LINE @ 25°C Unless otherwise specified

PART NUMBER	DEVICE MARKING	STAND OFF VOLTAGE	BREAKDOWN VOLTAGE	CLAMPING VOLTAGE	CLAMPING VOLTAGE	STANDBY CURRENT	CAPACITANCE	CAPACITANCE
		V_{WM}	V_{BR}	V_C	V_C	I_b	@0V 1 MHz)	@0V 1 MHz)
		VOLTS	VOLTS	VOLTS	VOLTS	μA	C	C
		MAX	MIN	MAX	MAX	MAX	MAX	MAX
SM03	M03	3.3	4	7	9	200	600	300
SM05	M05	5.0	6.0	9.8	11	20	400	200
SM12	M12	12.0	13.3	19	24	0.1	160	80
SM15	M15	15.0	16.7	24	30	0.1	130	65
SM24	M24	24.0	26.7	43	55	0.1	80	40
SM36	M36	36.0	40.0	60	75	0.1	70	35

Note: Transient Voltage Suppressor (TVS) product is normally selected based on its stand off voltage V_{WM} . Product selected voltage should be equal to or greater than the continuous peak operating voltage of the circuit to be protected.

SYMBOLS & DEFINITIONS

Symbol	DEFINITION
V_{WM}	Rated stand off voltage: Maximum dc voltage that can be applied over the operating temperature range. V_{wm} must be selected to be equal or be greater than the operating voltage of the line to be protected
V_{BR}	Minimum Breakdown Voltage: The minimum voltage the device will exhibit at a specified current
V_C	Clamping Voltage: Maximum clamping voltage across the TVS device when subjected to a given current at a pulse time of 20 μs .
I_D	Standby Current: Leakage current at V_{WM} .
C	Capacitance: Capacitance of the TVS as defined @ 0 volts at a frequency of 1 MHz and stated in Pico Farads.

GRAPHS

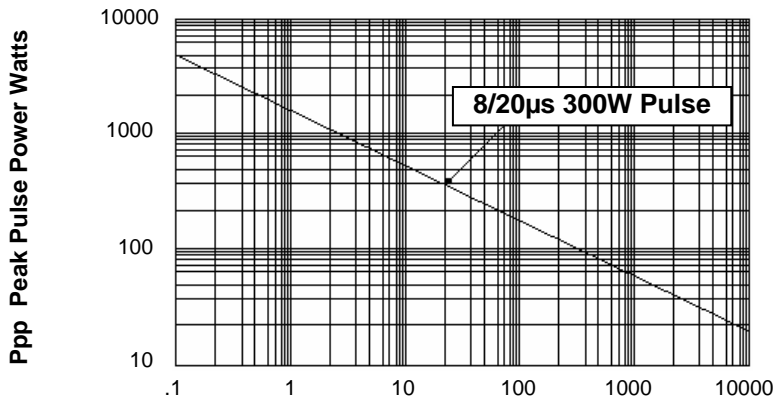

FIGURE 1
Peak Pulse Power Vs Pulse Time $t = \mu s$

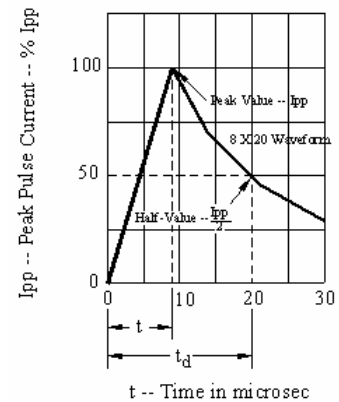
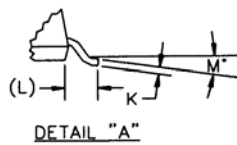
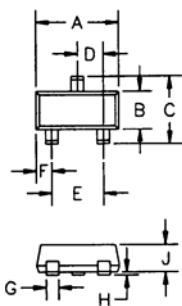
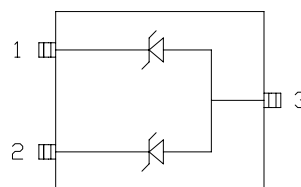
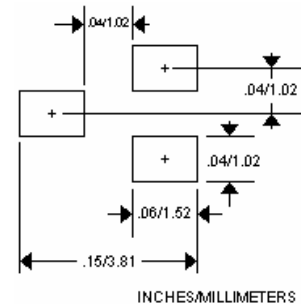

FIGURE 2
Pulse Wave Form

PACKAGING AND SCHEMATIC



DIM*	DIMENSIONS (I)				NOTE
	MIN	MAX	MIN	MAX	
A	.110	.119	2.8	3.04	--
B	.047	.055	1.20	1.40	--
C	.083	.104	2.10	2.64	--
D	.035	.040	0.88	1.02	--
E	.070	.081	1.78	2.05	--
F	.017	.024	.44	.60	--
G	.014	.020	.37	.51	--
H	.0005	.004	.013	0.10	--
J	.034	.040	.87	1.02	--
K	.003	.007	.085	.180	--
L	--	.022	--	0.55	REF
M	0	8"	0	8"	--



SCHEMATIC