



MIC2827

Triple Output PMIC with HyperLight Load™ DC-DC, two LDOs, and I²C Control

General Description

The Micrel MIC2827 is a three output, programmable Power Management IC, optimized for high efficiency power support in Mobile Application Processors, Co-Processors, DSPs, GPS and Media Player chipsets. The device integrates a single 500mA PWM/PFM synchronous buck (step-down) regulator with two Low Dropout Regulators and a 400kHz I²C interface that provides programmable Dynamic Voltage Scaling (DVS), Power Sequencing, and individual output Enable/Disable controls allowing the user to optimally control all three outputs.

The 4MHz synchronous buck regulator features a patented HyperLight Load™ (HLL) architecture which minimizes switching losses and provides low quiescent current operation for high efficiency at light loads. Additional benefits of this proprietary architecture are low output ripple voltage and fast transient response throughout the entire load range with the use of small output capacitors, reducing the overall system size.

Two high performance LDOs are integrated into the MIC2827 to provide additional system voltages for I/O, memory and other analog functions. Each LDO is capable of sourcing 150mA output current with high PSRR and low output noise. A 2% output voltage accuracy, low dropout voltage (150mV @ 150mA), and low ground current of 83µA (both LDOs operating) makes this device ideally suited for mobile applications.

The MIC2827 is available in a tiny 14-pin 2.5mm x 2.5mm Thin MLF[®] with a junction operating range from -40°C to +125°C.

Data sheets and support documentation can be found on Micrel's web site at: www.micrel.com.

Applications

- Application processors
- GPS subsystems
- General purpose PMIC
- Mobile phones / PDAs
- Portable media players
- Mobile television receivers

Features

- Fast-mode I²C control interface
- Tiny 14-pin 2.5mm x 2.5mm MLF[®] package
- Default start-up voltage states and sequencing
- Fault indication processor flag - IRQb
- -40°C to 125°C junction temperature range
- Thermal shutdown and current-limit protection
- Power On After Fault (POAF) function

DC-DC Synchronous Buck

- 2.7V to 5.5V input voltage range
- 500mA continuous output current
- HyperLight Load™ mode
 - 25µA quiescent current
- 90% peak efficiency; 85% at 1mA
- Ultra-fast transient response
- Dynamic Voltage Scaling (DVS) range: 0.8V to 1.8V
 - 0.8V to 1.2V in 25mV steps
 - 1.2V to 1.8V in 50mV steps
- ±3% over temperature
- Low output voltage ripple: 20mVpp in HyperLight Load™ mode, 3mV in full PWM mode

LDOs

- 1.8V to V_{DVIN} input voltage range
- 150mA output current (each LDO)
- Dynamic Voltage Scaling (each LDO)
 - DVS range: 0.8V to 3.3V in 50mV steps
- ±3% over temperature
- Low quiescent current – 50µA (each LDO)
- Low dropout voltage – 50mV @ 50mA
- Low output noise - 45µV_{RMS}
- Stable with ceramic output capacitors
- 65dB PSRR at 1kHz

HyperLight Load is a trademark of Micrel, Inc

MLF and MicroLeadFrame are registered trademarks of Amkor Technology, Inc.

Micrel Inc. • 2180 Fortune Drive • San Jose, CA 95131 • USA • tel +1 (408) 944-0800 • fax +1 (408) 474-1000 • <http://www.micrel.com>

Typical Application

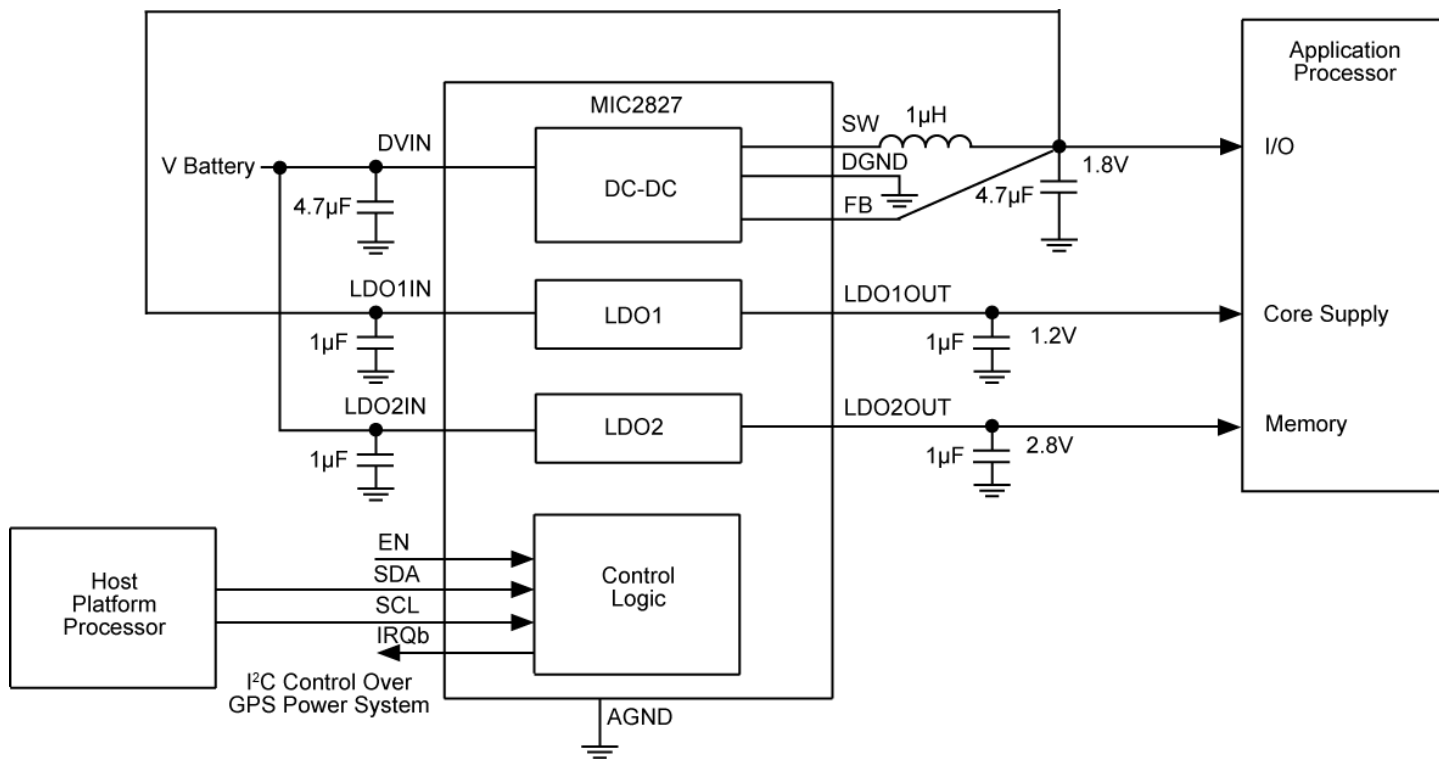

Ordering Information

Part Number	Marking Code ⁽²⁾	Default Start Up Voltages ⁽¹⁾			Default Start Up Sequence ⁽¹⁾			Junction Temp. Range	Package ⁽³⁾
		DC-DC	LDO1	LDO2	DC-DC	LDO1	LDO2		
MIC2827-B2YMT	827B2	1.8V	1.2V	2.8V	1	2	3	-40°C to +125°C	14-Pin 2.5x2.5mm Thin MLF [®]

Note:

1. Other Default voltages and sequences are available on request (Voltages: 0.8V to 3.3V_{OUT} LDOs, and 0.8V to 1.8V_{OUT} PWM). Please contact Micrel Marketing for other voltage ranges.
2. Thin MLF[®] Pin 1 Identifier symbol is “▲”.
3. Thin MLF[®] is a Green RoHS compliant package. Lead finish is NiPdAu. Mold compound is Halogen Free.

Pin Configuration

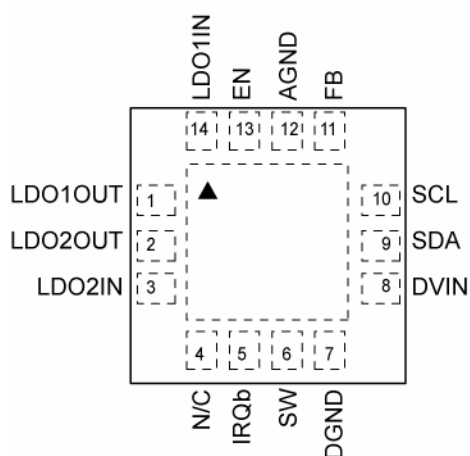

14-Pin 2.5mm x 2.5mm Thin MLF[®] (MT)
(Top View)

Pin Description

Pin Number	Pin Name	Pin Function
1	LDO1OUT	Output of LDO1: Requires a minimum 1 μ F ceramic capacitor-to-AGND.
2	LDO2OUT	Output of LDO2: Requires a minimum 1 μ F ceramic capacitor-to-AGND.
3	LDO2IN	External Input Supply Rail to LDO2. Requires a minimum 1 μ F ceramic capacitor to AGND.
4	N/C	
5	IRQb	Fault Output (open drain).
6	SW	Switch (Output): Internal power MOSFET output switches.
7	DGND	Switch Ground Pin.
8	DVIN	Input Voltage: Requires a close minimum 2.2 μ F ceramic capacitor to DGND.
9	SDA	Fast-mode 400kHz I ² C Data Input/Output pin.
10	SCL	Fast-mode 400kHz I ² C Clock Input pin.
11	FB	Feedback Pin Connected to VOUT to sense output voltage.
12	AGND	Analog Ground. Must be connected externally to DGND.
13	EN	Enable (Input): Executes default startup sequence. Active High. HIGH = ON, LOW = OFF. Do not leave floating. The EN pin function is optional if I ² C control is used for startup and shutdown.
14	LDO1IN	External Input Supply Rail to LDO1. Requires a minimum 1 μ F ceramic capacitor to AGND.
EP	HS PAD	Exposed Heat-Sink Pad.

Absolute Maximum Ratings⁽¹⁾

Supply Voltage (V_{DVIN} , V_{LDO1IN} , V_{LDO2IN}).....	-0.3V to +6V
Enable Voltage (V_{EN})	-0.3V to +6V
I ² C Voltage (V_{SDA} , V_{SCL})	-0.3V to +6V
Power Dissipation	Internally Limited ⁽³⁾
Lead Temperature (Soldering, 10 sec.).....	260°C
Storage Temperature (T_S).....	-65°C ≤ T_J ≤ +150°C
ESD Rating ⁽⁴⁾	2kV

Operating Ratings⁽²⁾

DVIN Supply voltage (V_{DVIN}).....	+2.7V to +5.5V
LDO Supply voltage (V_{LDO1IN} , V_{LDO2IN}).....	+1.8V to V_{DVIN}
Enable Input Voltage (V_{EN}).....	0V to V_{DVIN}
I ² C Voltage (V_{SDA} , V_{SCL})	0V to +5.5V
Junction Temperature Range (T_J).....	-40°C to +125°C
Junction Thermal Resistance	
2.5mm x 2.5mm Thin MLF-14 (θ_{JA})	89°C/W

Electrical Characteristics⁽⁵⁾ – DC/DC Converter

DVIN = EN = 3.6V; LDO1, LDO2 disabled; L=1μH, C_{OUT}=4.7μF, I_{OUT}= 20mA, T_A = 25°C, unless otherwise specified.

Bold values indicate -40°C ≤ T_J ≤ +125°C.

Parameter	Conditions	Min	Typ	Max	Units
Supply Voltage Range		2.7		5.5	V
Under-Voltage Lockout Threshold	Rising	2.45	2.55	2.65	V
Switcher Quiescent Current, HLL	I _{OUT} = 0mA, FB > 1.2 * V _{OUT} Nominal		25	35	μA
Shutdown Current	EN = 0V, DVIN = 5.5V		2	5	μA
Output Voltage Accuracy	DVIN = 3.6V; I _{LOAD} = 20mA	-3		+3	%
Current Limit in PWM Mode	FB = 0.9* V _{OUT} (NOM)	0.55	1		A
Output Voltage Line Regulation	DVIN = 3.0V to 5.5V, I _{LOAD} = 20mA		0.4		%/V
Output Voltage Load Regulation	20mA < I _{LOAD} < 500mA, DVIN = 3.6V		0.5		%
PWM Switch ON-Resistance	I _{SW} = 100mA PMOS		0.55		Ω
	I _{SW} = -100mA NMOS		0.6		Ω
Frequency	I _{LOAD} = 120mA		4		MHz
SoftStart Time	V _{OUT} = 90%		300		μs
Enable Voltage	OFF			0.2	V
	ON	1.2			
Enable Input Current			0.1	2	μA
Over-temperature Shutdown			160		°C
Over-temperature Shutdown Hysteresis			20		°C
VPOR Threshold % of V _{OUT} below Nominal	V _{OUT} Ramping Up		91		%
	V _{OUT} Ramping Down		89		%
Auto-Discharge NFET resistance			280		Ω

Notes:

- Exceeding the absolute maximum rating may damage the device.
- The device is not guaranteed to function outside its operating rating.
- The maximum allowable power dissipation of any T_A (ambient temperature) is P_{D(max)} = (T_{J(max)} - T_A) / θ_{JA}. Exceeding the maximum allowable power dissipation will result in excessive die temperature, and the regulator will go into thermal shutdown.
- Devices are ESD sensitive. Handling precautions recommended. Human body model, 1.5kΩ in series with 100pF.
- Specification for packaged product only.

Electrical Characteristics - LDO1, LDO2

DVIN = EN = LDO1IN = LDO2IN = 3.6V; DC-DC disabled; LDO C_{OUT} = 1μF, LDO I_{OUT} = 100μA, T_A = 25°C, unless otherwise specified. **Bold** values indicate -40°C ≤ T_J ≤ +125°C.

Parameter	Conditions	Min	Typ	Max	Units
Output Voltage Accuracy	Variation from nominal V _{OUT}	-3.0		+3.0	%
Input voltage	I _{OUT} = 100μA to 150mA;	2			V
	I _{OUT} = 100μA to 100mA; -20°C to +100°C	1.74			V
Output Voltage DVS Range	Adjustable through I ² C Registers	0.8		3.3	V
Line Regulation	LDO1IN, LDO2IN = V _{OUT} + 1V to 5.5V; I _{OUT} = 100μA		0.014	0.1	%/V
Load Regulation	I _{OUT} = 100μA to 75mA		4		mV
Dropout Voltage	I _{OUT} = 50mA; V _{OUT} = 2V		70	350	mV
	I _{OUT} = 150mA; V _{OUT} = 2V		200		mV
	I _{OUT} = 50mA; V _{OUT} = 3V		50		mV
	I _{OUT} = 150mA; V _{OUT} = 3V		150		mV
Ground Pin Current	EN = DVIN				
	1 LDO enabled 2 LDOs enabled		50 83		μA μA
Ripple Rejection	f = up to 1kHz; C _{OUT} = 1μF; V _{OUT} = 2.5V		65		dB
	f = 1kHz - 10kHz; C _{OUT} = 1μF V _{OUT} = 2.5V		45		dB
Current Limit	V _{OUT} = 0V	190	400	550	mA
Output Voltage Noise	C _{OUT} = 1μF, 10Hz to 100kHz		45		μV _{RMS}
Auto-Discharge NFET resistance			280		Ω

Electrical Characteristics – I²C Interface

DVIN = EN = 3.6V, T_A = 25°C, unless otherwise specified. **Bold** values indicate -40°C ≤ T_J ≤ +125°C.

Parameter	Conditions	Min	Typ	Max	Units
LOW-Level Input Voltage				0.2	V
HIGH-Level Input Voltage		1.2			V
SDA Pull-down resistance	Open drain pull-down on SDA during read back		80		Ω
IRQb Pull-down resistance	Open drain pull-down		55		Ω

Typical Characteristics

Thermal Shutdown

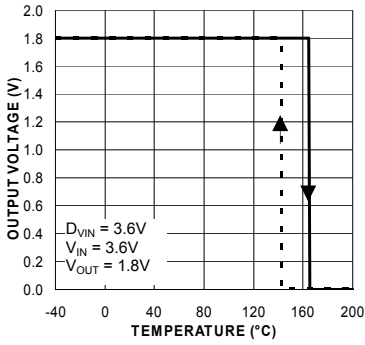

Enable Threshold vs. Temperature

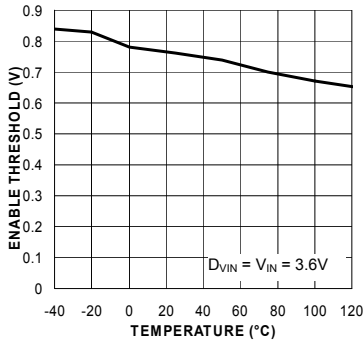

Enable Threshold vs. Input Voltage

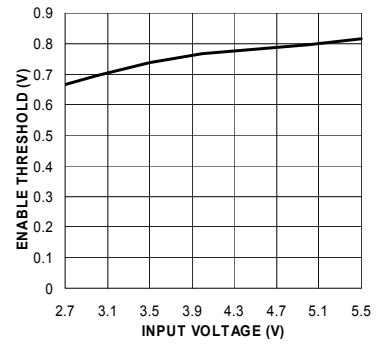

LDO Input Voltage PSRR

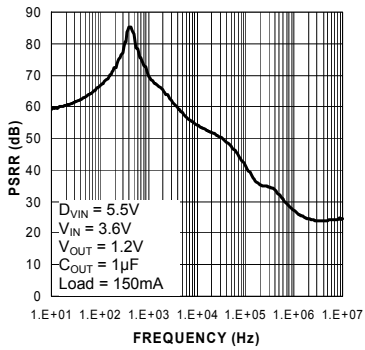

LDO Output Noise Spectral Density

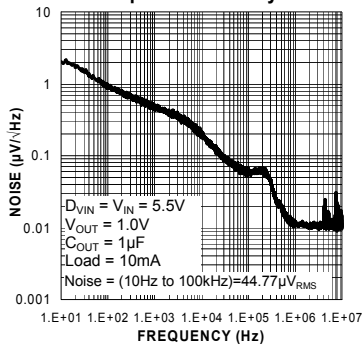

Dropout Voltage vs. Load Current

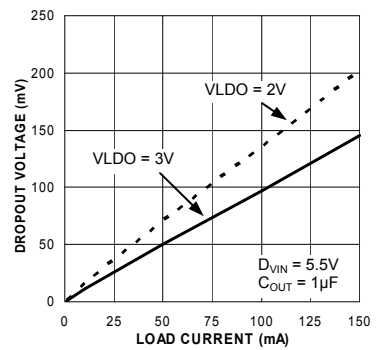

Dropout Voltage vs. Temperature

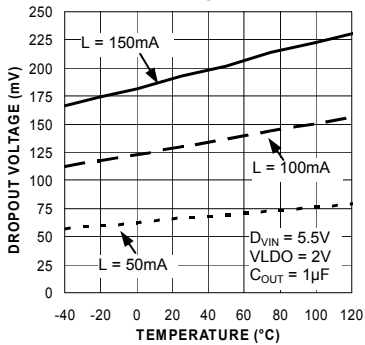

Dropout Voltage vs. Temperature

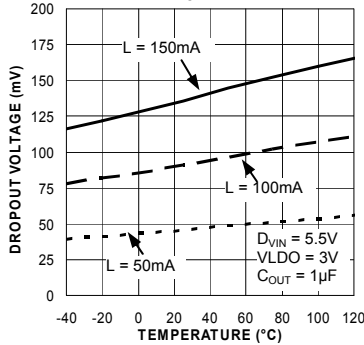

LDO Output Voltage vs. Temperature

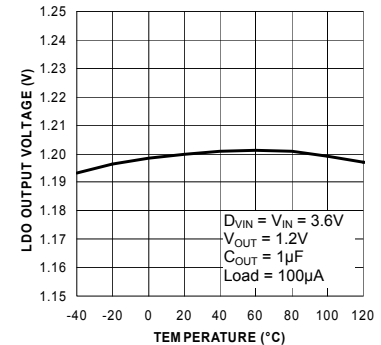

LDO Output Voltage vs. Load Current

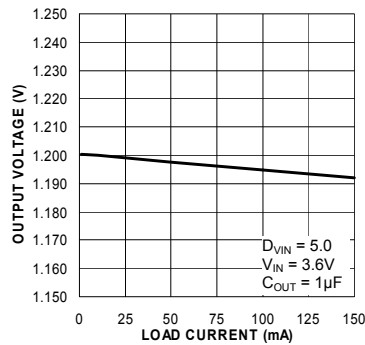

LDO Output Voltage vs. Input Voltage

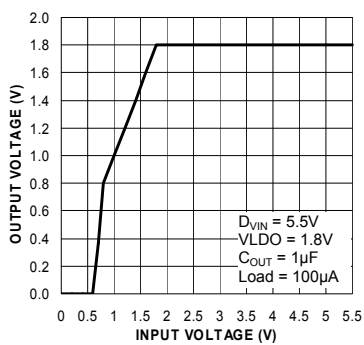

LDO Current Limit vs. Input Voltage

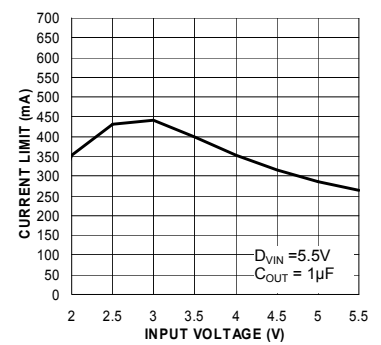

Typical Characteristics (continued)

LDO Current Limit vs. Temperature

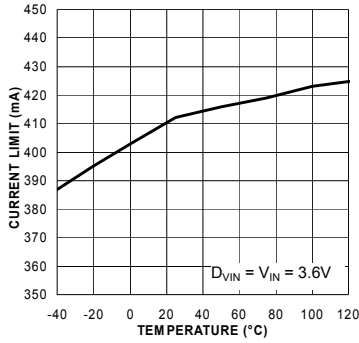

LDO Ground Current vs. Temperature

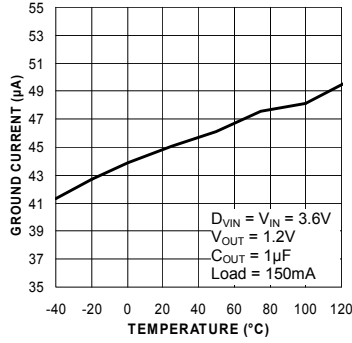

LDO Ground Current vs. Input Voltage

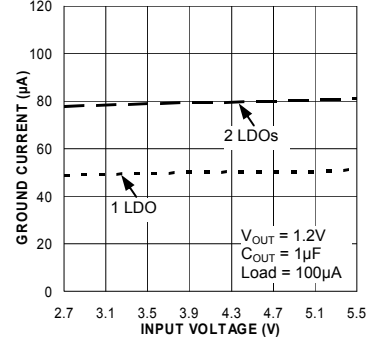

LDO Ground Current vs. Load Current

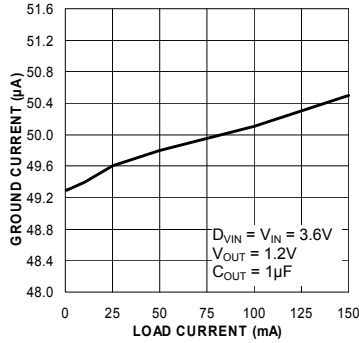

DC-DC Efficiency VOUT=1.0V

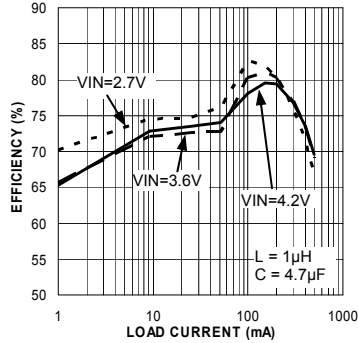

DC-DC Efficiency VOUT=1.2V

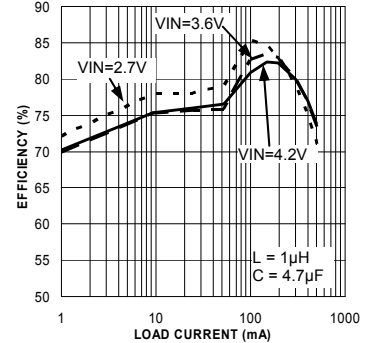

DC-DC Efficiency VOUT=1.5V

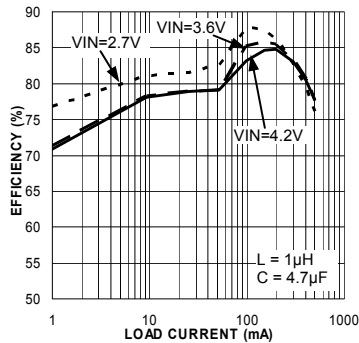

DC-DC Efficiency VOUT=1.8V

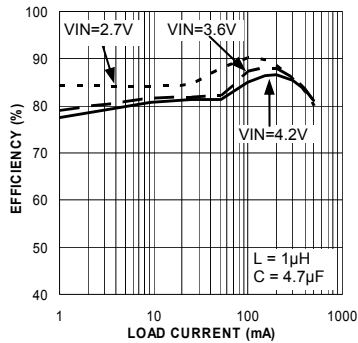

DC-DC Switching Frequency vs. Load Current

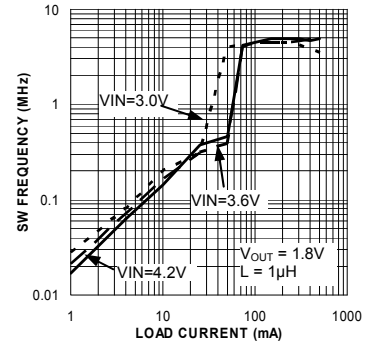

DC-DC Switching Frequency vs. Load Current

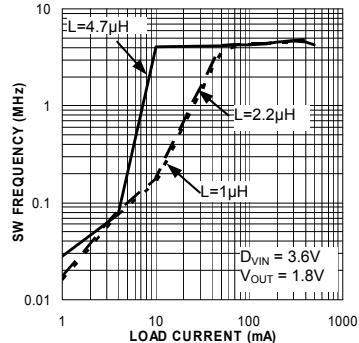

DC-DC Switching Frequency vs. Temperature

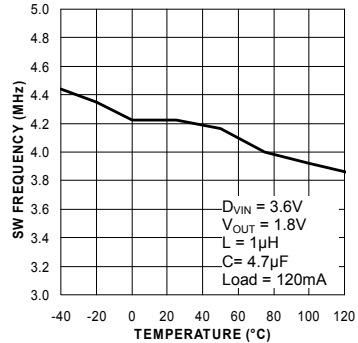

DC-DC Switching Frequency vs. Input Voltage

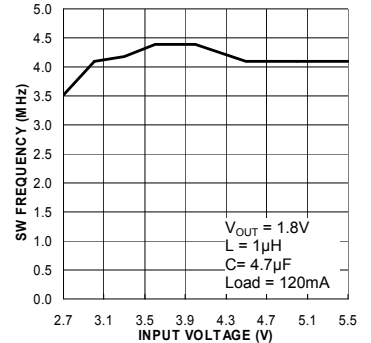

Typical Characteristics (continued)

DC-DC Output Voltage vs. Load Current

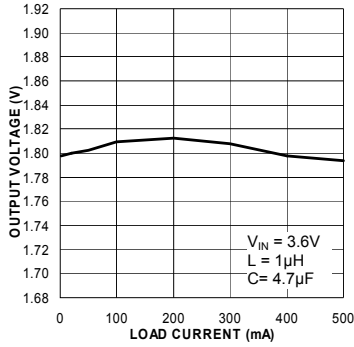

DC-DC Output Voltage vs. Temperature

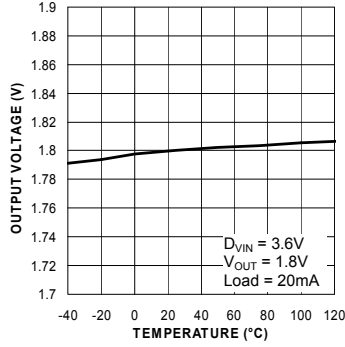

DC-DC Output Voltage vs. Input Voltage

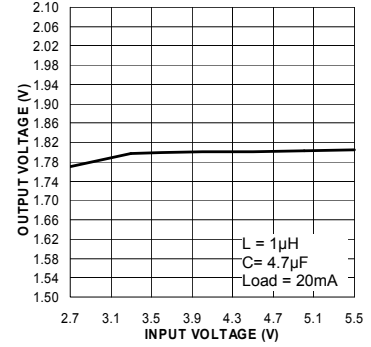

DC-DC Current Limit vs. Input Voltage

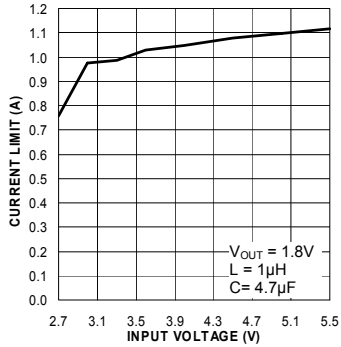

Current Limit vs. Temperature

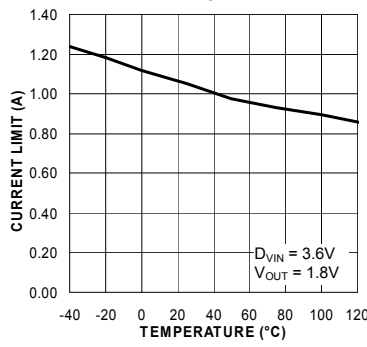

RDSON (PMOS) vs. Temperature

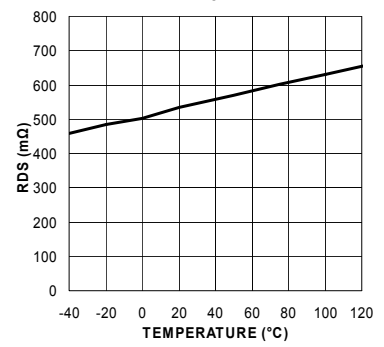

RDSON (NMOS) vs. Temperature

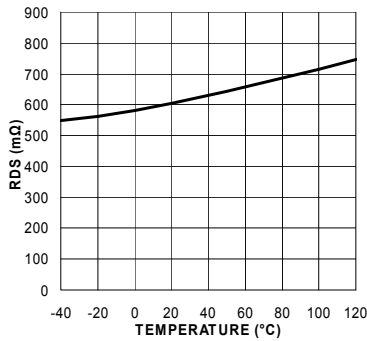

RDSON (PMOS) vs. Input Voltage

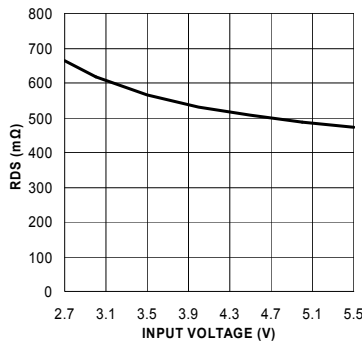

RDSON (NMOS) vs. Input Voltage

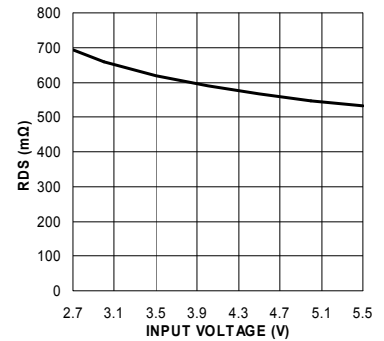

Quiescent Current vs. Temperature

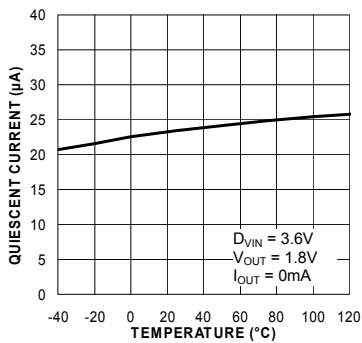

Quiescent Current vs. Input Voltage

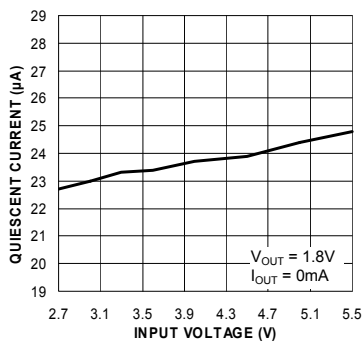

Functional Characteristics

DC-DC Load Transient

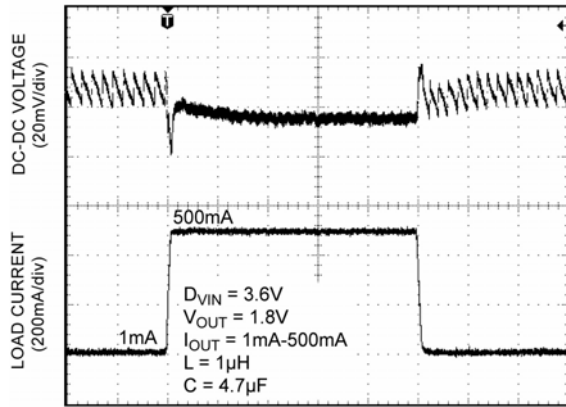

Time (40µs/div)

DC-DC Line Transient

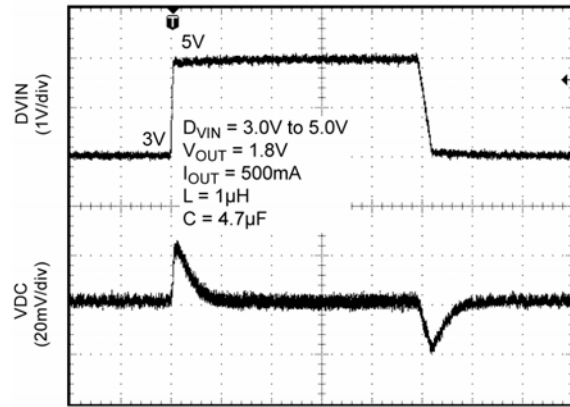

Time (100µs/div)

Enable Turn-On (D9 option)

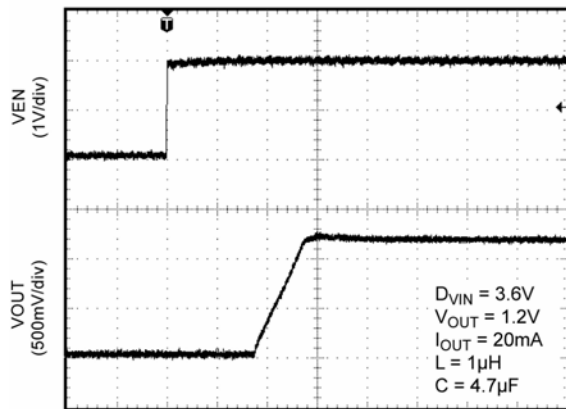

Time (100µs/div)

Enable Turn-On (D9 option)

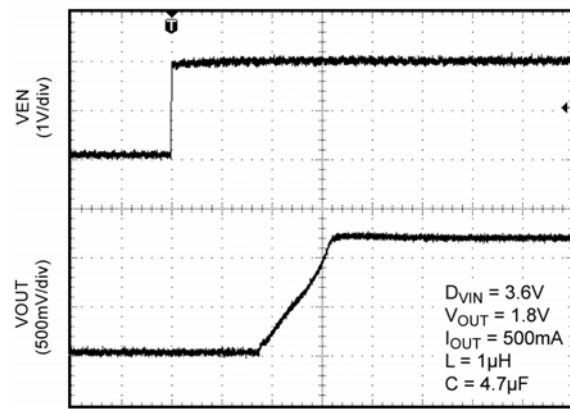

Time (100µs/div)

Switching Waveform - Discontinuous Mode

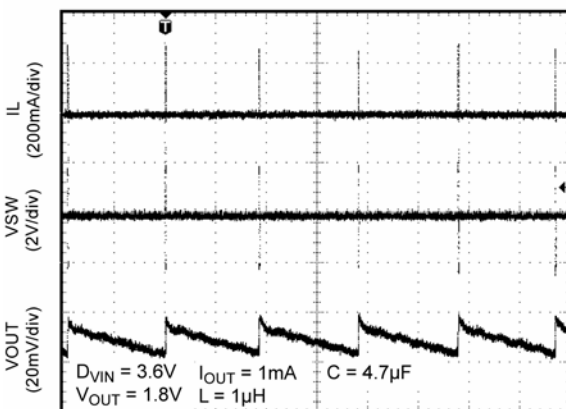

Time (40µs/div)

Switching Waveform - Discontinuous Mode

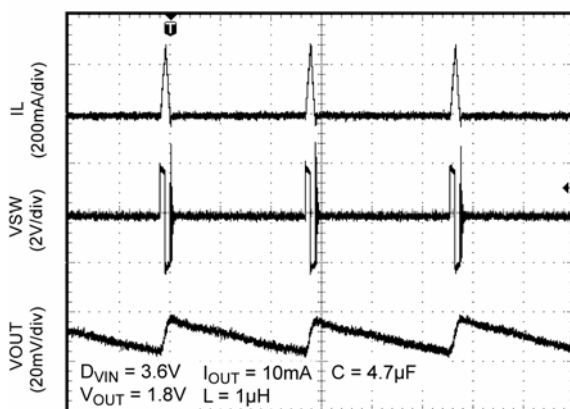

Time (2µs/div)

Functional Characteristics (continued)

Switching Waveform - Continuous Mode

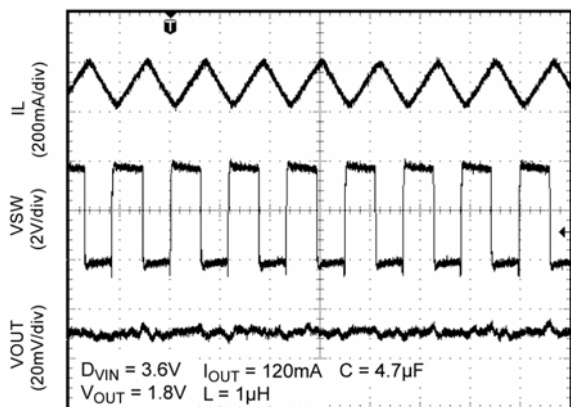

Time (200ns/div)

Switching Waveform - Continuous Mode

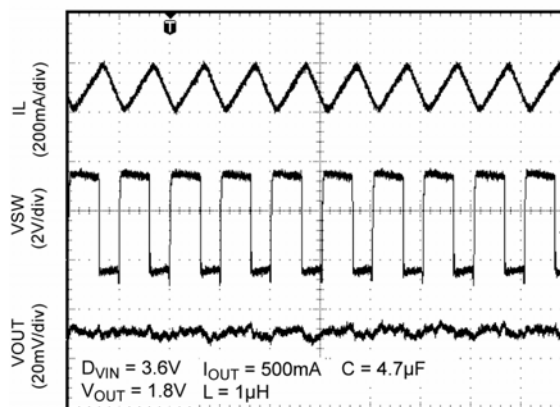

Time (200ns/div)

LDO Load Transient

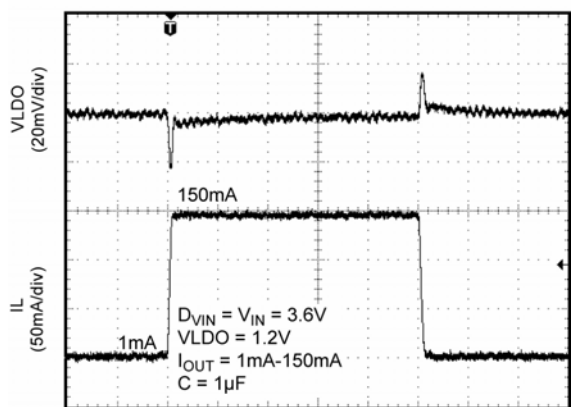

Time (40μs/div)

LDO Line Transient

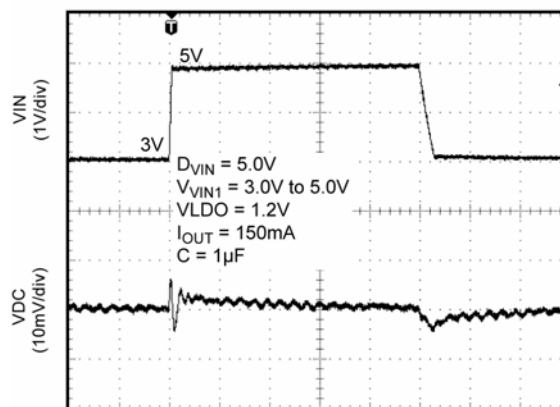

Time (20μs/div)

Functional Block Diagram

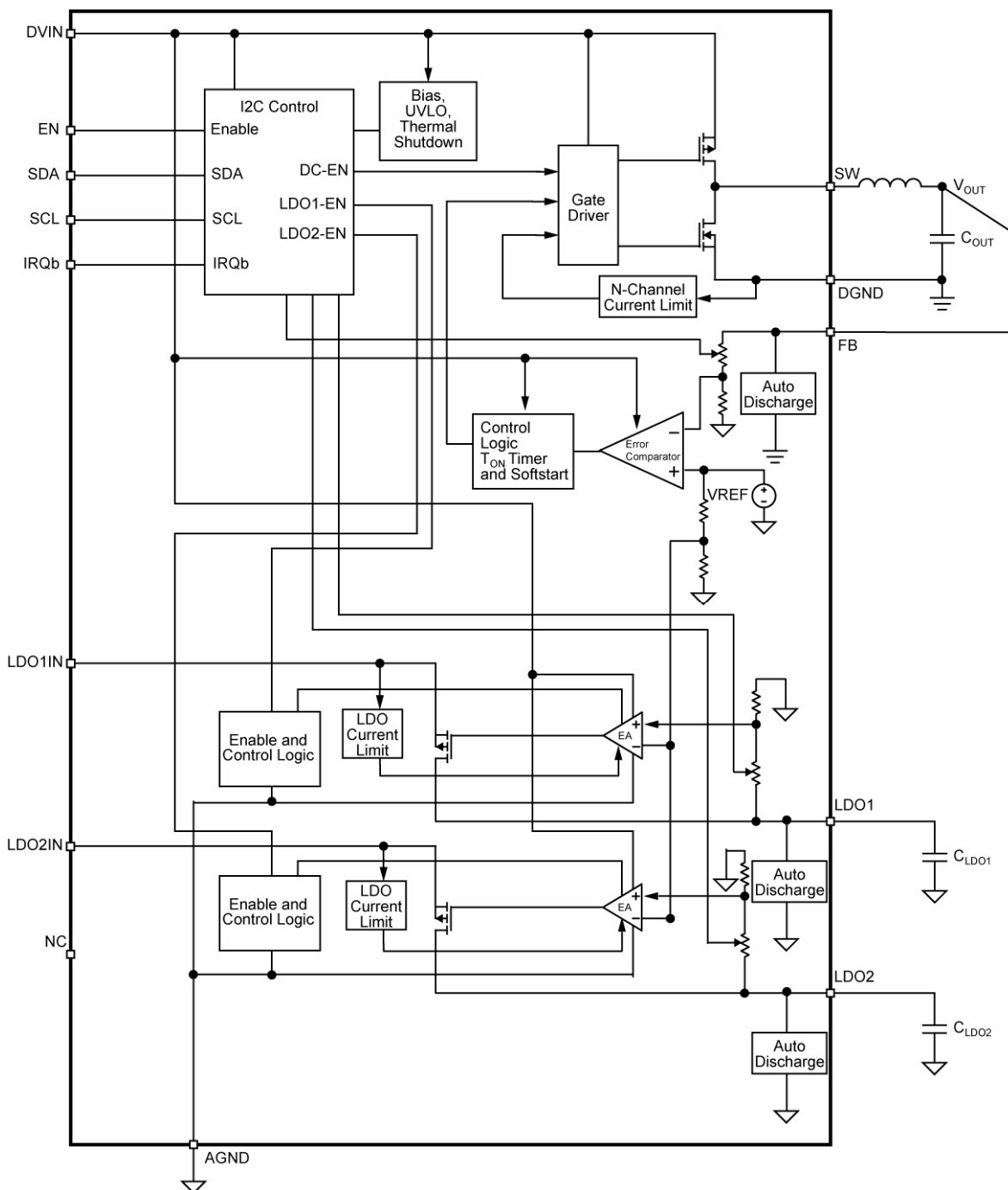

MIC2827 Block Diagram

Functional Description – Power Control and Sequencing

Two Types of Part: Sequence-Enabled and No-Sequence

- Sequence-Enabled parts support automatic sequencing of the three supplies. Sequence-Enabled parts all have a default sequence (activated by asserting the EN pin). These parts also allow sequencing to be disabled.

While very flexible, sequence-enabled parts require more care in operation. See the later section “Ensuring Clean Switching in Sequence-Enabled Parts”.

- No-Sequence parts have no built-in sequencing capability. Their default startup turns on only one supply, which requires no sequencing. If the host needs more supplies to come on, this can be accomplished with I²C writes which allows a sequence activated by software to be performed.

Power-up State

When battery power is first applied to the MIC2827, all I²C registers are loaded with their default (POR) values.

If EN is high, a default startup is executed; otherwise, the part remains in a quiescent state waiting to be started by EN or an I²C command.

Enable Pin-Initiated Default Startup

When EN is asserted, a default startup is executed. This is defined below:

- The voltage registers are loaded with their default values.
- In sequence-enabled parts, the Sequence Control bit is set to low (to allow sequencing to occur). No-sequence parts always have zero for the Sequence Control bit
- The correct set of supply enable bits is loaded into the Enable Register, and the appropriate sequence is then executed.
- The Power-On After Fault (POAF) bit is set to its default state, high.

Turning on the Power Supplies

After power is applied, the MIC2827 offers two methods of turning the three supply outputs on and off:

1. Default startup sequencing or shutdown via the EN pin;
2. Flexible startup sequencing or shutdown via the I²C interface

Power-Up via the EN Pin

The EN pin is transition sensitive and not level sensitive (with the exception of hot enable—please see the description below). If the EN pin is toggled low-to-high, the MIC2827 will execute the default startup sequence.

During the startup sequence, the appropriate set of supply enables is loaded into the Enable Register. This allows the part to present a consistent interface to the I²C host; if the host reads the Enable Control register, it will see one or more enables on, which is consistent with one or more active supplies.

Individual control of the supplies is now possible via the I²C interface.

“Hot Enable” Startup

Some systems may choose to tie the EN pin to DVIN, so that the MIC2827 registers an active EN pin as it completes power-on. This is perfectly legal and produces a default startup immediately after power is applied. Depending on the rise time of the input power being applied, the UVLO flag may be set.

Power-Down via the EN Pin

If the EN pin is toggled high-to-low, then the MIC2827 will shut down all outputs simultaneously. For reasons similar to those above, at the conclusion of the shutdown sequence, all three individual supply enables will be clear in the Enable Control register and the bias will be switched off.

If the MIC2827 startup is initiated by asserting EN and later shutdown is initiated by clearing the Enable Register bits, the part will be quiescent (with all bias currents disabled) but EN will still be high. In this case, de-asserting EN will have no effect, since the part has already completed its shutdown.

Power-Up and Power-Down via the Enable Register

The three individual power supply enable bits in the Enable Register (LDO2-EN, LDO1-EN, and DC-EN) may be used to enable and disable individual supplies. If the part is sequenced-enabled, and sequencing is permitted by the Sequence Control bit, enabled supplies are turned on in sequence. Any disabled outputs will not participate in the sequence and will be ignored.

See also the “Ensuring Clean Switching in Sequence-Enabled Parts” section.

Under no circumstances should the EN and I²C control be used simultaneously. The results would not be deterministic.

If a supply output is enabled and its Voltage Control register is written with a new value, the output voltage changes immediately at the I²C acknowledge.

Fault Handling

A fault is generated from either a thermal shutdown or under-voltage lockout event. If a fault occurs, the activation of the fault condition immediately turns off all output supplies, sets the fault flag bit(s) in the Status Register, and loads default values in the Enable and Voltage Registers. The sequence Control bit SEQ CNT is cleared to enable sequencing for sequence-enabled parts. The POAF bit is unaffected.

The default state of the Enable Register's POAF (Power On After Fault) bit is high, indicating that the MIC2827 will perform a default start up when the fault goes away. If the user instead prefers that the part does not automatically attempt re-start after a fault, the POAF can be programmed to a "0".

The EN pin can be toggled high-to-low at any time to clear the supply enables in the Enable Register and shut down the part. The same can be achieved through I²C at any time by disabling all enables in the enable register. Either method can be used to shut down the part during a fault.

Shutdown after a fault will maintain the fault flags in the status register. Only Power-on-Reset or an echo reset of the status register will clear these flags.

Thermal Shutdown (TSD)

If the MIC2827's on-chip thermal shutdown detects that the die is too hot, the part will immediately turn off all outputs but maintain the bias to internal circuitry. The thermal event is logged in the Status register which can be read via I²C. When the thermal shutdown event is removed, a default startup is executed if POAF is high.

Under Voltage Lock Out (UVLO)

If the MIC2827's on-chip voltage monitor detects a low voltage on the DVIN supply, the part will immediately turn off all outputs but maintain the bias to internal circuitry. When the UVLO event is removed, the outputs will turn on using the default startup if POAF is high. The UVLO event is logged in the status register which can be read via I²C.

If the power on DVIN drops too low, the MIC2827 will no longer be able to function reliably and will enter its power-on reset (POR) state. Any previously raised TSD or UVLO flags will now be cleared at startup

Power Good Indication and Hysteresis

The status of all three outputs can be read via I²C in the status register. A register flag is set for each output when it reaches 90% of its regulated value and cleared when the output falls to about 85%.

Interrupt Operation

If interrupts are enabled (INT-EN = 1), then the MIC2827's IRQb output will be asserted (driven low) whenever either of the two fault bits, UVLO or TSD, are asserted. Clearing the fault status bit by writing a one to it will clear the interrupt if the fault condition is no longer present. If the fault is still present, the status bit will be asserted again, together with the IRQb output. This operation does not depend on the state of the POAF bit.

The default state of the INT_EN bit is zero, so the interrupt output is disabled. This is done so that the interrupt pin does not transition in MIC2827 systems which use only the EN pin and not the I²C interface.

Ensuring Clean Switching in Sequence-Enabled Parts

In no-sequence parts, no sequencing ever occurs, and no special rules are required. However, in sequence-enabled parts, care must be taken when using automatic supply startup sequencing.

The sequence-enabled MIC2827 accomplishes supply sequencing by asynchronously using one supply's power good signal to enable the next supply in line. As a consequence "downstream" supplies can momentarily switch off their outputs when "upstream" supplies are switched in and out of the sequencing chain.

Example:

Suppose the sequence [DC, 1, 2] is enabled and LDO1 is off, the others are enabled and their status is valid. If LDO1 is now enabled through I²C, LDO2 will turn momentarily off, until LDO1 is valid, which then starts LDO2.

To avoid this, the following rules should be observed, which apply only to sequence-enabled parts:

1. If all supplies are to be turned on, it is fine to use sequencing. This is what happens naturally as part of the EN-initiated default startup. It may also be accomplished by setting all three supply enables simultaneously in the Enable Register, and leaving the Sequence Control bit low to permit sequencing.
2. When starting from an all-off condition and a subset of the supplies is to be turned on, sequencing is permitted.
3. When one or more supplies are on, and a supply is to be turned off or on, sequencing must be disabled by setting SEQ CNT high.
4. When a subset of the supplies has been turned on via the Enable Register, an active transition on the EN pin must not be used to turn on the remaining supplies.

Sequencing rules do not apply to the last supply in the sequencing chain (the supply labeled “3rd” in the sequence table). The 3rd supply may be turned on and off at any time, since there are no downstream supplies from the 3rd.

Available Default Startup Sequences

The following table shows available default startup sequences for the MIC2827. Please contact Micrel factory to request customized default startup voltages and sequences.

Sequence Number	DC-DC	LDO1	LDO2	Sequence-Enabled Part?
Sequence 2	1st	2nd	3rd	Yes

Enable Sequence 2

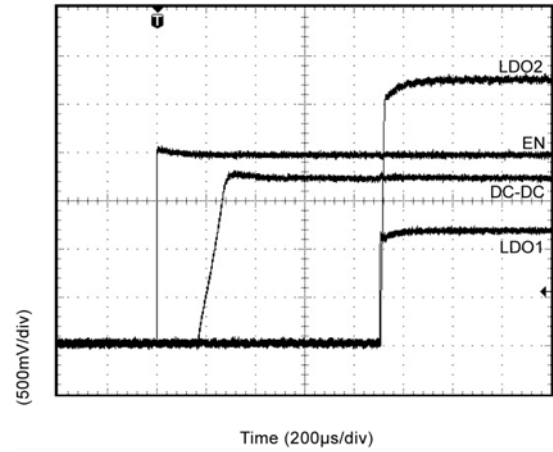

Functional Description – Fast-mode I²C Interface

I²C Address

The seven-bit I²C address of the MIC2827 is set at the factory to 1011010 binary, which would be identified as B4h using standard I²C nomenclature, in which the read/write bit takes the least significant position of the eight-bit address. Other I²C base addresses are available; please contact Micrel for details.

Electrical Characteristics – Serial Interface Timing

$3.0V \leq V_{DVIN} \leq 3.6V$ unless otherwise noted. **Bold** values indicate $-40^{\circ}C \leq T_A \leq +125^{\circ}C$.

Symbol	Parameter	Conditions	Min	Typ	Max	Units
t_1	SCL (clock) period		2.5			μs
t_2	Data In Setup Time to SCL High		100			ns
t_3	Data Out Stable After SCL Low		0			ns
t_4	SDA Low Setup Time to SCL Low	Start	100			ns
t_5	SDA High Hold Time after SCL High	Stop	100			ns

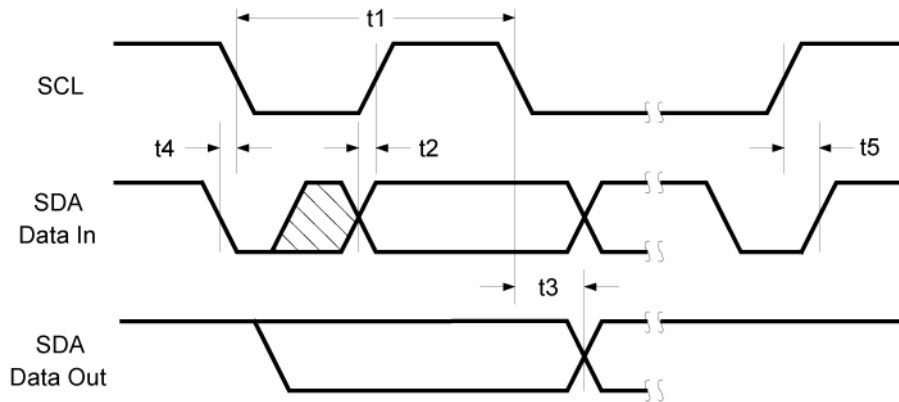

Serial Interface Timing

Serial Port Operation

The MIC2827 uses standard Write_Byte, Read_Byte, and Read_Word operations for communication with its host. The Write_Byte operation involves sending the device's address (with the R/W bit low to signal a write operation), followed by the register address and the command byte. The Read_Byte operation is a composite write and read operation; the host first sends the device's address followed by the register address, as in a write operation. A new start bit must then be sent to

the MIC2827, followed by a repeat of the device address with the R/W bit (LSB) set to the high (read) state. The data to be read from the part may then be clocked out. These protocols are shown in Figure 1 and Figure 2.

The Register Address is eight bits (one byte) wide. This byte carries the address of the MIC2827 register to be operated upon. Only the lower three bits are used.

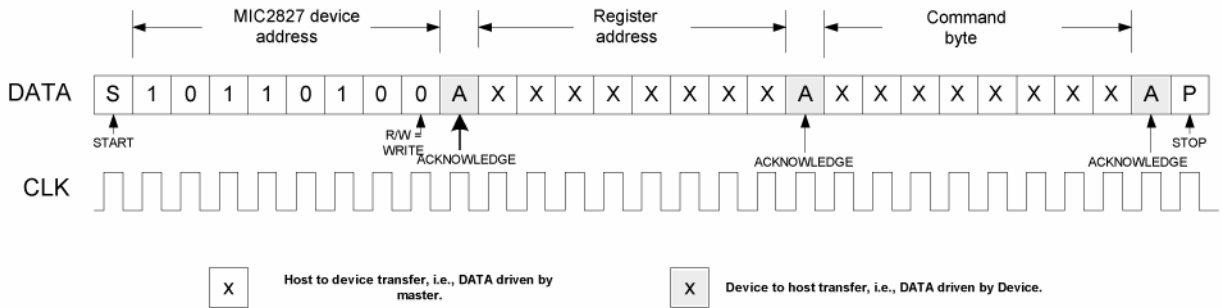

Figure 1: Write_Byte protocol

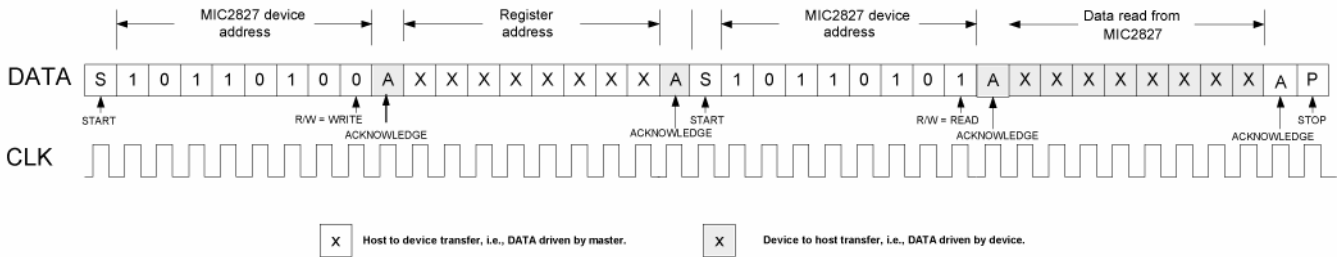

Figure 2: Read_Byte protocol

Functional Description – I²C Control Registers

Register Address	Register Name	Read/Write	Description
00h	Enable	R/W	Enable and startup control register
01h	Status	R/W	Regulator output & fault condition status register
02h	DC-DC	R/W	DC-DC regulator voltage control register
03h	LDO1	R/W	LDO1 voltage control register
04h	LDO2	R/W	LDO2 voltage control register

Enable/Startup Control Register (00h):

The Enable Register is used to allow control of the MIC2827's power supplies. It allows each supply to be turned on and off, and whether sequencing is used.

When a default startup is executed as a result of the EN pin being taken from low to high, the Sequence Control, and Supply Enable bits are all set to their default values.

The Sequence Control bit, only implemented in sequence-enabled parts, must be used carefully. See the section on "Ensuring Clean Switching in Sequence-Enabled Parts".

	D7	D6	D5	D4	D3	D2	D1	D0
Name	Reserved		POAF	SEQ CNT	Reserved	LDO2-EN	LDO1-EN	DC-EN
Access	N/A		R/W	R/W	N/A	R/W	R/W	R/W
POR Value	00		1	0	0	0	0	0
Data	00		0 = Remain off after fault 1 = Restore power after fault	0 = Sequencing enabled 1 = Sequencing disabled	0 = Disable 1 = Enable			
Set by Default Startup?	Yes		Yes	Yes	Yes	Yes		
Set by a fault?	No		No	Yes	No	Yes, if POAF=1		

Status Register (01h):

The Status Register allows the state of each supply to be interrogated, supports flags that are set when fault conditions occur, and controls the use of the MIC2827's interrupt pin.

	D7	D6	D5	D4	D3	D2	D1	D0
Name	Reserved	INT-EN	UVLO	TSD	Reserved	L2-Status	L1-Status	DC-Status
Access	RO	R/W	Echo reset	Echo reset	RO	RO	RO	RO
POR Value	0	0	0	0	0	0	0	0
Data	0	0: Interrupt is disabled 1: Interrupt is enabled	0: Normal 1: DVIN under-voltage occurred	0: Normal 1: Thermal shutdown occurred	0	0 = LDO2 Not Valid 1 = LDO2 Valid	0 = LDO1 Not Valid 1 = LDO1 Valid	0 = DC-DC Not Valid 1 = DC-DC Valid

Note:

"Echo reset" bits remain set until cleared. Clearing these bits is accomplished by writing a one to that bit location ("echo the one to reset"). If the fault condition (UVLO or thermal shutdown) persists after the echo reset, the corresponding Status Register bit will be set high again immediately.

DC-DC Regulator Voltage Control Register (02h)

This register controls the output voltage of the DC-DC PWM/PFM Regulator. The DC-DC Regulator employs a dual scale voltage step size to cover a wide range of output voltages from 0.8V to 1.8V. From 0.8V to 1.2V a step size of 25mV allows maximum power saving when the Processor Core is placed into a light load state. From 1.2V to 1.8V, a step size of 50mV provides a wide range of output voltages for power system flexibility.

DC-DC Regulator Voltage Control Register Table

DC-DC Regulator Voltage Control Register Address: 02h

Step Size	Register Value	Output Voltage
25mV	00h	0.800
	01h	0.825
	02h	0.850
	03h	0.875
	04h	0.900
	05h	0.925
	06h	0.950
	07h	0.975
	08h	1.000
	09h	1.025
	0Ah	1.050
	0Bh	1.075
	0Ch	1.100
	0Dh	1.125
	0Eh	1.150
	0Fh	1.175
50mV	10h	1.200
	11h	1.250
	12h	1.300
	13h	1.350
	14h	1.400
	15h	1.450
	16h	1.500
	17h	1.550
	18h	1.600
	19h	1.650
	1Ah	1.700
	1Bh	1.750
1Ch	1.800	

LDO1, LDO2 Voltage Control Registers Table

LDO1 Regulator Voltage Control Register Address: 03h

LDO2 Regulator Voltage Control Register Address: 04h

Step Size	Register Value	Output Voltage	Step Size	Register Value	Output Voltage
50mV	00h	0.800	50mV	BAh	2.400
	0Bh	0.850		BDh	2.450
	14h	0.900		C1h	2.500
	1Dh	0.950		C4h	2.550
	25h	1.000		C7h	2.600
	2Eh	1.050		C9h	2.650
	37h	1.100		CCh	2.700
	3Eh	1.150		CEh	2.750
	45h	1.200		D1h	2.800
	4Ch	1.250		D3h	2.850
	52h	1.300		D6h	2.900
	57h	1.350		D8h	2.950
	5Ch	1.400		DAh	3.000
	61h	1.450		DCh	3.050
	65h	1.500		DEh	3.100
	69h	1.550		E1h	3.150
	6Dh	1.600		E3h	3.200
	72h	1.650		E6h	3.250
	79h	1.700		E8h	3.300
	7Fh	1.750			
	85h	1.800			
	8Bh	1.850			
	91h	1.900			
	96h	1.950			
	9Ah	2.000			
	9Fh	2.050			
	A4h	2.100			
	A8h	2.150			
ACh	2.200				
B0h	2.250				
B4h	2.300				
B7h	2.350				

Functional Description

DVIN

The DVIN pin provides power to the source of the internal switch P-channel MOSFET, I²C control and voltage references for the MIC2827. The DVIN operating voltage range is from 2.7V to 5.5V. In order for any MIC2827 outputs to regulate, the appropriate input voltage must be applied to the DVIN pin. Due to the high switching speeds, a 4.7μF capacitor is recommended as close as possible to the DVIN and power ground (DGND) pin for bypassing. Please refer to layout recommendations.

LDO1IN

LDO1IN provides power to the source of the LDO1 P-channel MOSFET. The LDO1IN operating voltage range is from 1.8V to V_{DVIN}. The recommended bypass capacitor is 1μF.

LDO2IN

LDO2IN provides power to the source of the LDO2 P-channel MOSFET. The LDO2IN operating voltage range is from 1.8V to V_{DVIN}. The recommended bypass capacitor is 1μF.

EN

The enable pin controls the ON and OFF state of all the outputs of the MIC2827. The EN pin is transition sensitive and not level sensitive. By toggling the enable pin low-to-high, this activates the default startup sequence of the part.

SW

The switching pin connects directly to one end of the inductor and provides the switching current during switching cycles. The other end of the inductor is connected to the load, output capacitor, and the FB pin. Due to the high speed switching on this pin, the switch node should be routed away from sensitive nodes.

FB

The feedback pin provides the control path to control the output. A recommended 4.7μF bypass capacitor should be connected in shunt with the DC-DC output. It is good practice to connect the output bypass capacitor to the DGND and FB should be routed to the top of C_{OUT}.

LDO1OUT

The LDO1OUT pin provides the regulated output voltage of LDO1. Power is provided by LDO1IN. LDO1OUT voltage can be dynamically scaled through I²C control. The recommended output capacitance is 1μF, decoupled to AGND.

LDO2OUT

The LDO2OUT pin provides the regulated output voltage of LDO2. Power is provided by LDO2IN. LDO2OUT voltage can be dynamically scaled through I²C control. The recommended output capacitance is 1μF, decoupled to AGND.

SCL

The I²C clock input pin provides a reference clock for clocking in the data signal. This is a fast-mode 400kHz input pin, and requires a 4.7kΩ pull-up resistor. Please refer to "Serial Port Operation" for more details.

SDA

The I²C data bidirectional pin allows for data to be written to and read from the MIC2827. This is a fast-mode 400kHz I²C pin, and requires a 4.7kΩ pull-up resistor. Please refer to "Serial Port Operation" for more details.

IRQb

The IRQb (open drain) pin provides an interrupt for when either the UVLO or TSD faults are asserted. When enabled through I²C, the IRQb pin will assert together with the corresponding fault condition. Please refer to the "Interrupt Operation" for more details.

DGND

Power ground (DGND) is the ground path for the DC-DC MOSFET drive current. The current loop for the Power ground should be as small as possible and separate from the Analog ground (AGND) loop. Refer to the layout consideration for more details.

AGND

Analog ground (AGND) is the ground path for the biasing and control circuitry. The current loop for the Analog ground should be separate from the Power ground (AGND) loop. Refer to the layout consideration for more details.

Application Information

The Micrel MIC2827 is a three output, programmable Power Management IC, optimized for high efficiency power support. The device integrates a single 500mA PWM/PFM synchronous buck (step-down) regulator with two Low Dropout Regulators and an I²C interface that provides programmable Dynamic Voltage Scaling (DVS), Power Sequencing, and individual output Enable/Disable controls allowing the user to optimally control all three outputs.

Input Capacitors

A 4.7μF ceramic capacitor is recommended on the DVIN pin for bypassing. X5R or X7R dielectrics are recommended for the input capacitor. Y5V dielectrics lose most of their capacitance over temperature and are therefore not recommended. Also, tantalum and electrolytic capacitors alone are not recommended because of their reduced RMS current handling, reliability, and ESR increases.

An additional 0.1μF is recommended close to the DVIN and DGND pins for high frequency filtering. Smaller case size capacitors are recommended due to their lower ESR and ESL.

Minimum 1.0μF ceramic capacitors are recommended on the LDO1IN and LDO2IN pins for bypassing. Please refer to layout recommendations for proper layout of the input capacitors.

Output Capacitors

The MIC2827 is designed for a 2.2μF or greater ceramic output capacitor for the DC-DC converter and 1.0μF for the LDO regulators. Increasing the output capacitance will lower output ripple and improve load transient response but could increase solution size or cost. A low equivalent series resistance (ESR) ceramic output capacitor such as the TDK C1608X5R0J475K, size 0603, 4.7μF ceramic capacitor is recommended based upon performance, size and cost. X5R or X7R dielectrics are recommended for the output capacitor. Y5V dielectrics lose most of their capacitance over temperature and are therefore not recommended.

In addition to a 4.7μF, a small 0.1μF is recommended close to the load for high frequency filtering. Smaller case size capacitors are recommended due to their lower equivalent series ESR and ESL.

Inductor

Inductor selection will be determined by the following (not necessarily in the order of importance);

- Inductance
- Rated current value
- Size requirements
- DC resistance (DCR)

The MIC2827 was designed for use with an inductance range from 0.47μH to 4.7μH. Typically, a 1μH inductor is recommended for a balance of transient response, efficiency and output ripple. For faster transient response a 0.47μH inductor may be used. For lower output ripple, a 4.7μH is recommended.

Proper selection should ensure the inductor can handle the maximum average and peak currents required by the load. Maximum current ratings of the inductor are generally given in two methods; permissible DC current and saturation current. Permissible DC current can be rated either for a 40°C temperature rise or a 10% to 20% loss in inductance. Ensure the inductor selected can handle the maximum operating current. When saturation current is specified, make sure that there is enough margin that the peak current will not saturate the inductor. Peak current can be calculated as follows:

$$I_{PEAK} = \left[I_{OUT} + V_{OUT} \left(\frac{1 - V_{OUT}/V_{IN}}{2 \times f \times L} \right) \right]$$

As shown by the previous calculation, the peak inductor current is inversely proportional to the switching frequency and the inductance; the lower the switching frequency or the inductance the higher the peak current. As input voltage increases, the peak current also increases.

The size of the inductor depends on the requirements of the application. Refer to the Application Circuit and Bill of Material for details.

DC resistance (DCR) is also important. While DCR is inversely proportional to size, DCR can represent a significant efficiency loss. Refer to the Efficiency Considerations.

Efficiency Considerations

Efficiency is defined as the amount of useful output power, divided by the amount of power supplied.

$$\text{Efficiency \%} = \left(\frac{V_{OUT} \times I_{OUT}}{V_{IN} \times I_{IN}} \right) \times 100$$

Maintaining high efficiency serves two purposes. It reduces power dissipation in the power supply, reducing the need for heat sinks and thermal design considerations and it reduces consumption of current for battery powered applications. Reduced current draw from a battery increases the devices operating time and is critical in hand held devices.

There are two types of losses in switching converters; DC losses and switching losses. DC losses are simply the power dissipation of I²R. Power is dissipated in the high side switch during the on cycle. Power loss is equal to the high side MOSFET R_{DS(ON)} multiplied by the Switch Current squared. During the off cycle, the low side N-channel MOSFET conducts, also dissipating power. Device operating current also reduces efficiency. The

product of the quiescent (operating) current and the supply voltage is another DC loss. The current required driving the gates on and off at a constant 4MHz frequency and the switching transitions make up the switching losses.

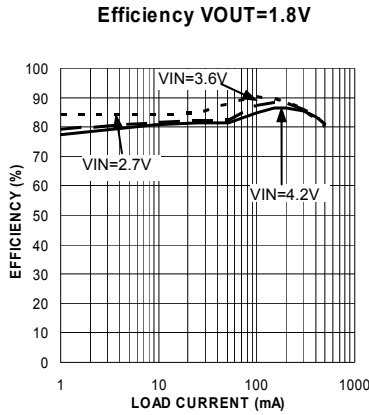

The Figure above shows an efficiency curve. From no load to 100mA, efficiency losses are dominated by quiescent current losses, gate drive and transition losses. By using the HyperLight Load™ mode the MIC2827 is able to maintain high efficiency at low output currents.

Over 100mA, efficiency loss is dominated by MOSFET $R_{DS(ON)}$ and inductor losses. Higher input supply voltages will increase the Gate-to-Source threshold on the internal MOSFETs, thereby reducing the internal $R_{DS(ON)}$. This improves efficiency by reducing DC losses in the device. All but the inductor losses are inherent to the device. In which case, inductor selection becomes increasingly critical in efficiency calculations. As the inductors are reduced in size, the DC resistance (DCR) can become quite significant. The DCR losses can be calculated as follows:

$$DCR \text{ Loss} = I_{OUT}^2 \times DCR$$

From that, the loss in efficiency due to inductor resistance can be calculated as follows:

$$Efficiency \text{ Loss} = \left[1 - \left(\frac{V_{OUT} \times I_{OUT}}{V_{OUT} \times I_{OUT} + L \cdot P_D} \right) \right] \times 100$$

Efficiency loss due to DCR is minimal at light loads and gains significance as the load is increased. Inductor selection becomes a trade-off between efficiency and size in this case.

HyperLight Load Mode™

The MIC2827 uses a minimum on and off time proprietary control loop (patented by Micrel). When the output voltage falls below the regulation threshold, the error comparator begins a switching cycle that turns the

PMOS on and keeps it on for the duration of the minimum-on-time. This increases the output voltage. If the output voltage is over the regulation threshold, then the error comparator turns the PMOS off for a minimum-off-time until the output drops below the threshold. The NMOS acts as an ideal rectifier that conducts when the PMOS is off. Using a NMOS switch instead of a diode allows for lower voltage drop across the switching device when it is on. The asynchronous switching combination between the PMOS and the NMOS allows the control loop to work in discontinuous mode for light load operations. In discontinuous mode, the MIC2827 works in pulse frequency modulation (PFM) to regulate the output. As the output current increases, the off-time decreases, thus providing more energy to the output. This switching scheme improves the efficiency of MIC2827 during light load currents by only switching when it is needed. As the load current increases, the MIC2827 goes into continuous conduction mode (CCM) and switches at a frequency centered at 4MHz. The equation to calculate the load when the MIC2827 goes into continuous conduction mode may be approximated by the following formula:

$$I_{LOAD} > \left(\frac{(V_{IN} - V_{OUT}) \times D}{2L \times f} \right)$$

As shown in the previous equation, the load at which MIC2827 transitions from HyperLight Load™ mode to PWM mode is a function of the input voltage (V_{IN}), output voltage (V_{OUT}), duty cycle (D), inductance (L) and frequency (f). This is illustrated in the graph below. Since the inductance range of MIC2827 is from 0.47µH to 4.7µH, the device may then be tailored to enter HyperLight Load™ mode or PWM mode at a specific load current by selecting the appropriate inductance. For example, in the graph below, when the inductance is 4.7µH the MIC2827 will transition into PWM mode at a load of approximately 5mA. Under the same condition, when the inductance is 1µH, the MIC2827 will transition into PWM mode at approximately 70mA.

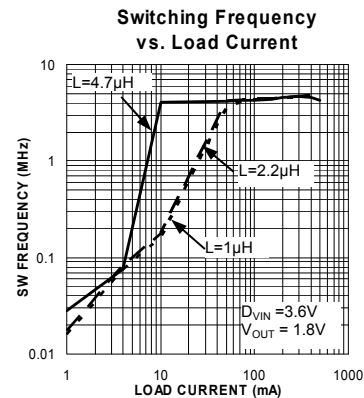

Recommended Schematic

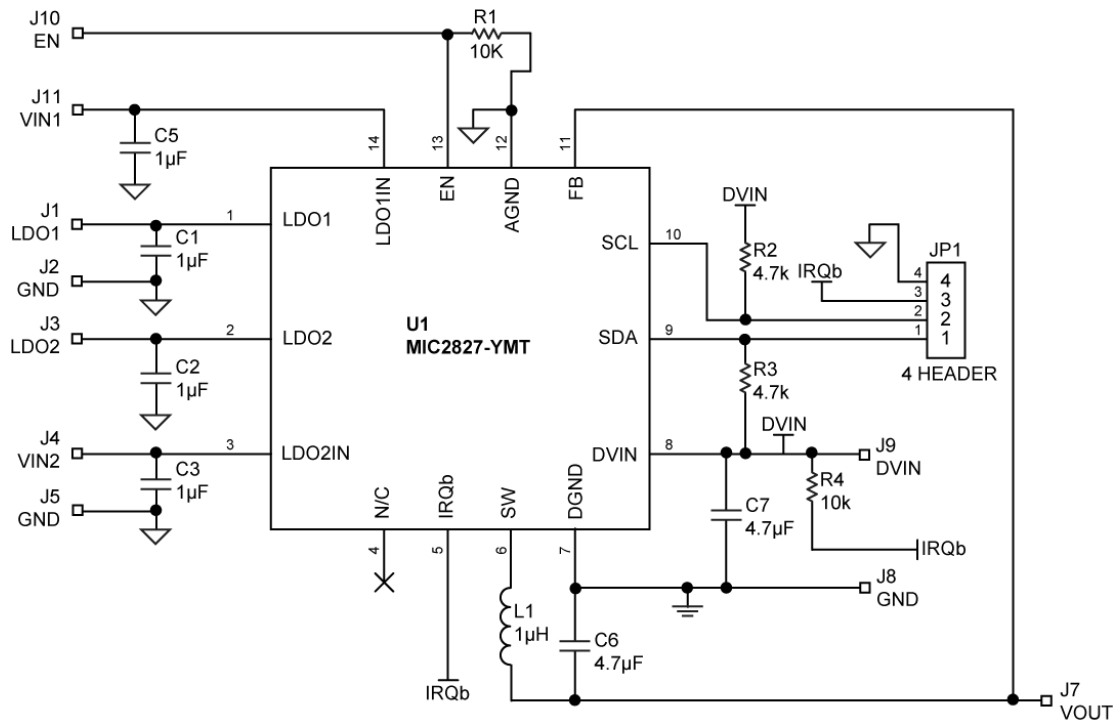

Bill of Materials

Item	Part Number	Manufacturer	Description	Qty.
C1, C2, C3, C5	GRM155R61A105KE15D	Murata ⁽¹⁾	Capacitor, 1µF, 10V, X5R, 0402 size	4
	C1005X5R0J105KT	TDK ⁽²⁾	Capacitor, 1µF, 10V, X5R, 0402 size	
C6, C7	GRM188R60J475K	Murata ⁽¹⁾	Capacitor, 4.7µF, 6.3V, X5R, 0603 size	2
	C1608X5R0J475M	TDK ⁽²⁾	Capacitor, 4.7µF, 6.3V, X5R, 0603 size	
R1, R4	CRCW040210K0FKEA	Vishay ⁽³⁾	Resistor, 10kΩ, 1%, 1/16W, 0402 size	2
R2, R3	CRCW04024K70FKEA	Vishay ⁽³⁾	Resistor, 4.7kΩ, 1%, 1/16W, 0402 size	2
JP1	0022152046	Molex ⁽⁴⁾	Connector, 2.54mm (0.1") Pitch PCB Connector, 4 circuits	1
L1	LQM21PN1R0MC0	Murata ⁽¹⁾	Inductor, 1.0µH, 0.8A, 2.0 x 1.25 x 0.5mm	1
	MLP2520S1R0L	TDK ⁽²⁾	Inductor, 1.0µH, 1.5A, 2.5 x 2.0 x 1.0mm	
	XPL2010-102ML	Coilcraft ⁽⁵⁾	Inductor, 1.0µH, 1.1A, 2.0 x 1.9 x 1.0mm	
	CIG21W1R0MNE	Samsung ⁽⁶⁾	Inductor, 1.0µH, 1.05A, 2.0 x 1.25 x 1.0mm	
U1	MIC2827-xxYMT	Micrel, Inc. ⁽⁷⁾	Triple Output PMIC with HyperLight Load™ DC-DC, Two LDOs, and I ² C Control	1

Notes:

1. Murata Tel: www.murata.com.
2. TDK: www.tdk.com.
3. Vishay Tel: www.vishay.com.
4. Molex.: www.molex.com.
5. Coilcraft: www.coilcraft.com.
6. Samsung: www.sem.samsung.com.
7. Micrel, Inc.: www.micrel.com.

Recommended Layout

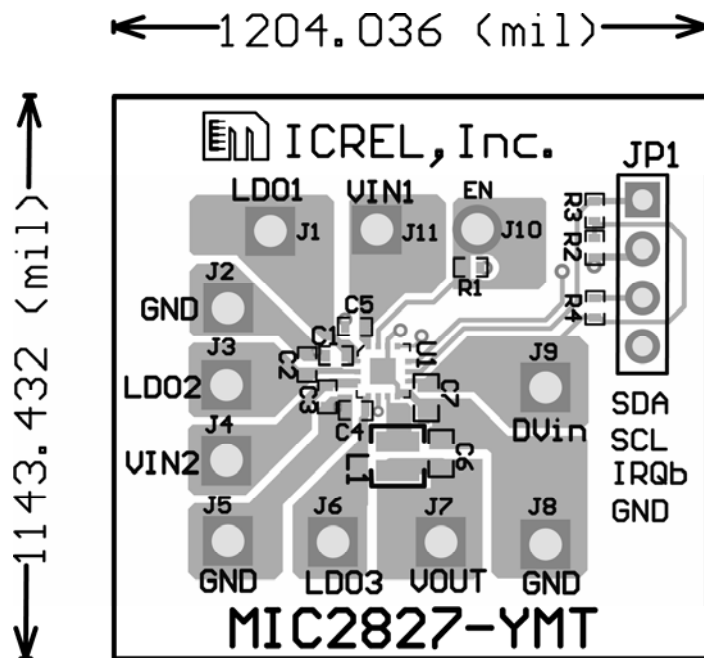

Top Layout

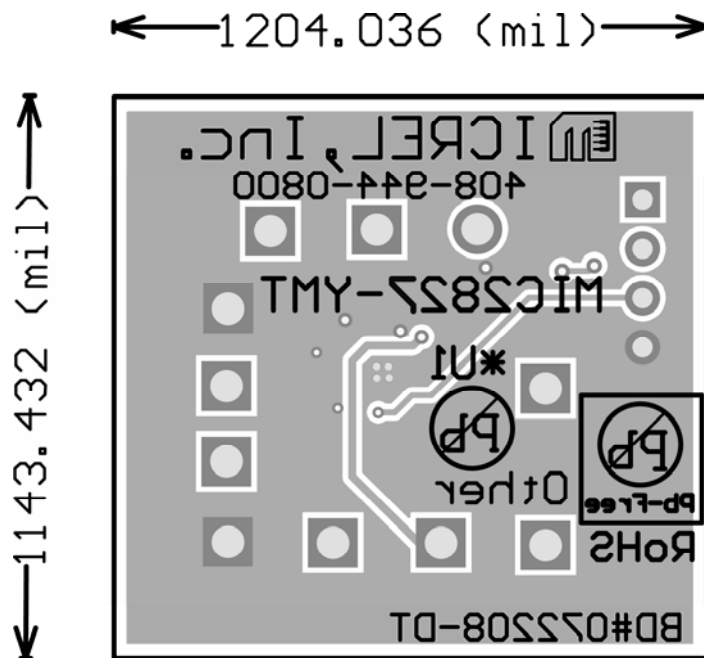

Bottom Layout

Package Information

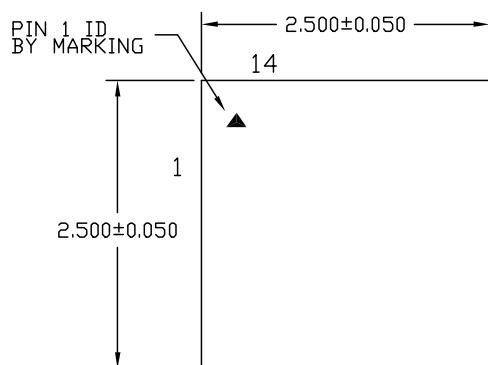

TOP VIEW

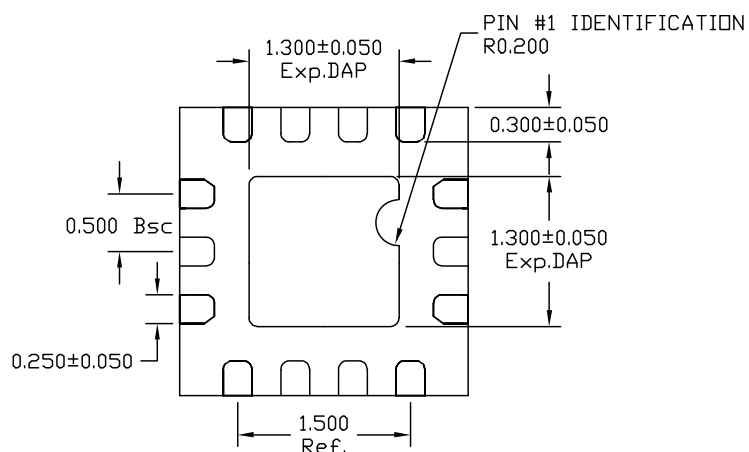

BOTTOM VIEW

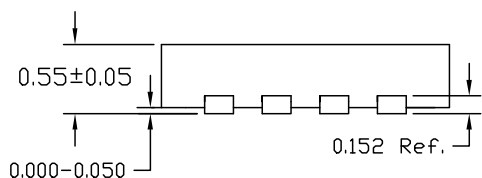

SIDE VIEW

NOTES :

1. ALL DIMENSIONS ARE IN MILLIMETERS.
2. MAX. PACKAGE WARPAGE IS 0.05 mm.
3. MAXIMUM ALLOWABLE BURRS IS 0.076 mm IN ALL DIRECTIONS.
4. PIN #1 ID ON TOP WILL BE LASER MARKED.

14-Pin 2.5mm x 2.5mm Thin MLF[®] (MT)

MICREL, INC. 2180 FORTUNE DRIVE SAN JOSE, CA 95131 USA
 TEL +1 (408) 944-0800 FAX +1 (408) 474-1000 WEB <http://www.micrel.com>

The information furnished by Micrel in this data sheet is believed to be accurate and reliable. However, no responsibility is assumed by Micrel for its use. Micrel reserves the right to change circuitry and specifications at any time without notification to the customer.

Micrel Products are not designed or authorized for use as components in life support appliances, devices or systems where malfunction of a product can reasonably be expected to result in personal injury. Life support devices or systems are devices or systems that (a) are intended for surgical implant into the body or (b) support or sustain life, and whose failure to perform can be reasonably expected to result in a significant injury to the user. A Purchaser's use or sale of Micrel Products for use in life support appliances, devices or systems is a Purchaser's own risk and Purchaser agrees to fully indemnify Micrel for any damages resulting from such use or sale.

© 2009 Micrel, Incorporated.