

**DESCRIPTION**

The GC4700 series diodes are specially processed PIN diodes designed for use in passive or active limiters at frequencies through Ku band. Thirteen categories of devices are offered for flexibility in design of low, medium and high power limiters. Low VB limiters have thinner I regions for faster turn-on time and better flat leakage. Microsemi also manufactures “gold doped” limiters for fastest turn on time. In addition, we manufacture high voltage dual junction limiters for superior peak and CW power handling.

This series of diodes meets RoHS requirements per EU Directive 2002/95/EC.

**KEY FEATURES**

- Available as packaged devices or as chips for hybrid applications
- Low Loss
- Suitable for applications to 18GHz
- Excellent flat leakage performance
- Low 1 dB compression point
- Gold Doped Diodes for Fast Turn On
- RoHS Compliant<sup>1</sup>

<sup>1</sup> Most of our devices are supplied with Gold plated terminations. Other terminal finishes are available on request. Consult factory for details.

**APPLICATIONS**

A diode limiter is a power-sensitive variable attenuator that uses the non-linear properties of the diode to provide an impedance mismatch when sufficient amounts of RF power are incident on the device. The output power is reduced to a level that will not overdrive a receiver, burn out a mixer, etc. For varying input power levels in excess of the diode's threshold level, the limiter's output power tends to remain constant.

A passive limiter is one in which the limiter diodes are “turned on” by the RF signal itself. An active limiter is one in which the limiter diodes are “turned on” primarily by an external bias current typically supplied by a Schottky detector diode which senses the incident signal.

Since limiter diodes are not designed to dissipate large amounts of power, the limiter must reflect or divert the excess incident power back to the source or to another load (i.e. via a circulator, hybrid coupler, etc.).

Limiter diodes may be used in wave guides, coax, microstrip, stripline or other media. Single or cascaded devices may be used, depending on power levels.

**APPLICATIONS/BENEFITS**

- Receiver protection circuits
- Amplifier Protection

**ABSOLUTE MAXIMUM RATINGS AT 25° C  
(UNLESS OTHERWISE SPECIFIED)**

Rating	Symbol	Value	Unit
Maximum Leakage Current @80% of minimum Rated Vb	I <sub>r</sub>	0.5	uA
Operating Temperature	T <sub>op</sub>	-55 to +150	°C
Storage Temperature	T <sub>stg</sub>	-65 to +150	°C

**IMPORTANT:** For the most current data, consult our website: [www.MICROSEMI.com](http://www.MICROSEMI.com)



These devices are ESD sensitive and must be handled using ESD precautions.

**CHIP ELECTRICAL PARAMETERS @ 25°C (unless otherwise specified)**

Model #	V <sub>b</sub> (Min)	C <sub>j0</sub> (Typ)	C <sub>j-6</sub> (Max)	C <sub>j-50</sub> (Max)	R <sub>s</sub> (Typ)	T <sub>L</sub> (Typ)	θP <sup>1</sup> (Typ)	θP <sup>2</sup> (Max)
	I <sub>R</sub> =10μA (Volts)	@0V (pF)	@-6V (pF)	@-50V (pF)	@10 mA (Ω)	(ns)	THERMAL RESISTANCE (°C/W)	THERMAL RESISTANCE (°C/W)
GC4701-00	20	0.20	0.15	--	1.5	5	20	100
GC4702-00	20	0.50	0.30	--	1.2	10	12	80
GC4711-00	45	0.20	0.15	--	1.5	10	15	80
GC4712-00	45	0.50	0.30	--	1.2	15	10	60
GC4713-00	45	0.70	0.50	--	1.0	20	6	40
GC4721-00	120	0.20	0.15	--	1.5	50	1.2	40
GC4722-00	120	0.60	0.30	--	1.0	50	0.5	20
GC4723-00	120	0.80	0.50	--	0.5	100	0.3	15
GC4731-00	15	0.12	0.10	--	2.0	5	30	120
GC4732-00	15	0.20	0.15	--	1.5	5	20	80
GC4741-00	30	0.12	0.10	--	2.0	7	20	100
GC4742-00	30	0.20	0.15	--	1.5	7	15	70
GC4750-002 <sup>(3)</sup>	250	--	--	0.25 <sup>(4)</sup>	3.0@50mA	300	4	10

**TYPICAL RF PERFORMANCE @ 25°C (unless otherwise specified)**

Model Number	V <sub>b</sub> (Min)	PEAK POWER P <sub>IN</sub> @ 1 μ S (dBm)	TYPICAL LEAKAGE P <sub>OUT</sub> (dBm)	TYPICAL THRESHOLD (dBm)	TYPICAL INS. LOSS L <sub>L</sub> (dB)	MAXIMUM CW POWER (Watts)
GC4701	20	+50	+22	+10	0.1	2
GC4702	20	+53	+24	+10	0.2	3
GC4711	45	+53	+27	+15	0.1	3
GC4712	45	+56	+29	+15	0.2	4
GC4713	45	+59	+31	+15	0.2	5
GC4721	120	+60	+39	+20	0.1	5
GC4722	120	+63	+41	+20	0.2	10
GC4723	120	+66	+44	+20	0.2	15
GC4731	15	+47	+19	+7	0.1	2
GC4732	15	+50	+22	+4	0.1	3
GC4741	30	+47	+24	+12	0.1	3
GC4742	30	+50	+27	+12	0.1	4
GC4750	250	+56 @10uS	+44	+31	0.2	50

## Notes

- 1) Pulse length 1 microsecond.
- 2) As measured in style 30 package
- 3) Available in 002 style or 115-2 package styles
- 4) C<sub>j</sub> for 2 junctions in parallel @ V<sub>R</sub>=50V

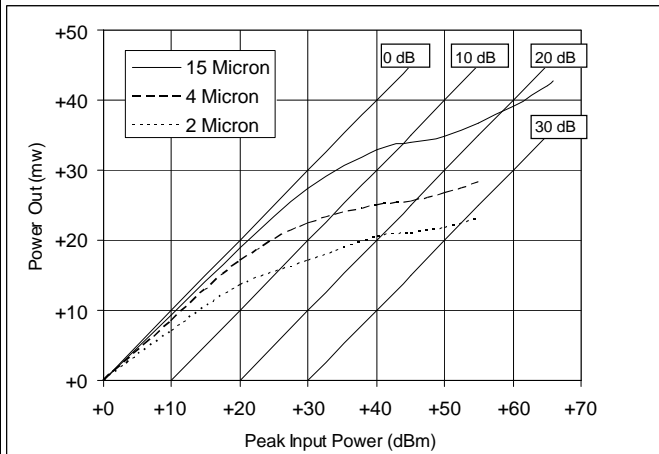
**POWER LEAKAGE PERFORMANCE**

Typical Power Leakage vs I Region Thickness

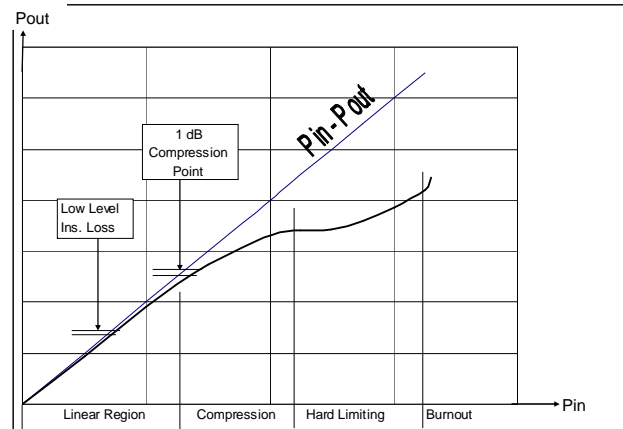
**TRANSFER CHARACTERISTICS**

Typical Limiter Transfer Characteristics

**SERIES RESISTANCE**

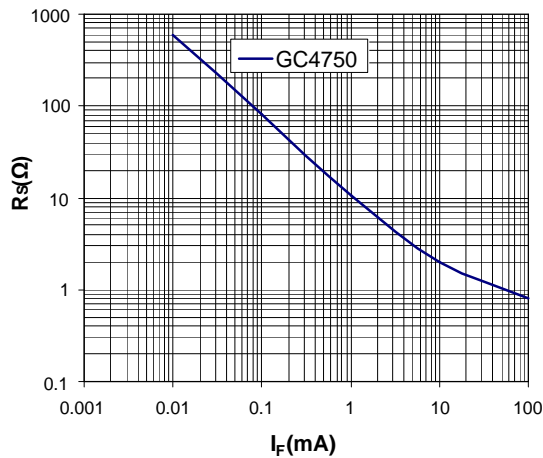
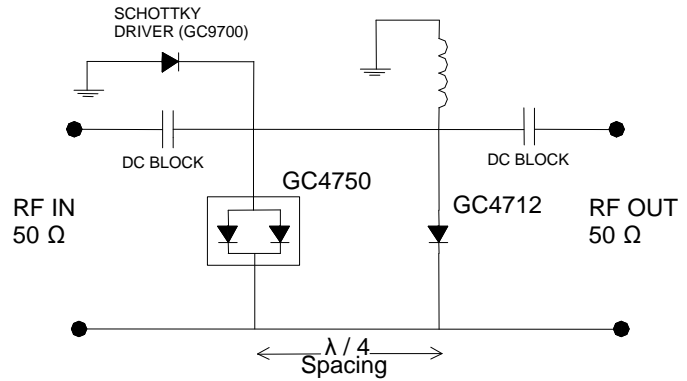
 Typical  $R_s$  Vs  $I_F$  Curve

**HIGH POWER DUAL LIMITER DESIGN**

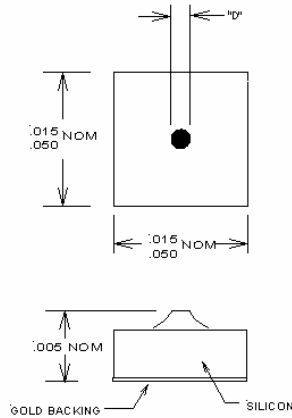
2 Stage Limiter with Schottky Driver

**PACKAGE STYLE 00**

NOTES:  
 1. TOP CONTACT, CHIP SIZE, AND CHIP THICKNESS DEPENDS ON DIODE PARAMETERS. CONSULT FACTORY.  
 2. TOP AND BOTTOM CONTACTS GOLD.

**Notes:**

- Order as GC47xx – 00

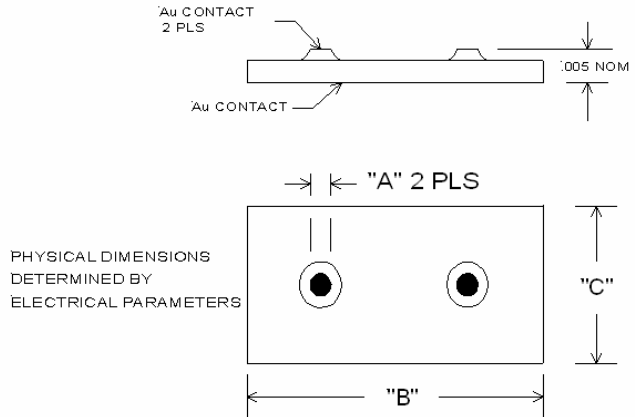
**DUAL CHIP STYLE 002**

**Notes:**

- Order as GC47xx – 002

**PACKAGE STYLE 30**

**Notes:**

- Order as GC47xx – 30

**PACKAGE STYLE 115-2**

**Notes:**

- Order as GC47xx – 115-2

**OTHER PACKAGE STYLES AVAILABLE ON REQUEST  
 CONSULT FACTORY**

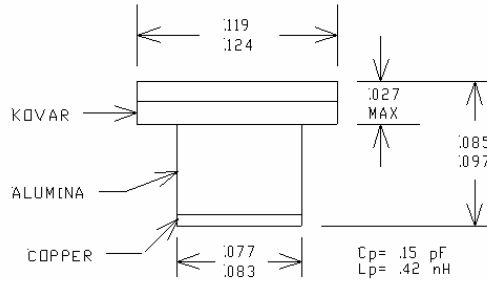
**PACKAGE STYLE 35**

## Notes:

- Order as GC47xx – 35

**PACKAGE SYLE 42**

## Notes:

- Order as GC47xx – 42

**OTHER PACKAGE STYLES AVAILABLE ON REQUEST  
 CONSULT FACTORY**

**NOTES**