

Microsemi
POWER PRODUCTS GROUP

APT2x61DQ60J 600V 60A
APT2x60DQ60J 600V 60A

DUAL DIE ISOTOP® PACKAGE

ULTRAFAST SOFT RECOVERY RECTIFIER DIODE

PRODUCT APPLICATIONS	PRODUCT FEATURES	PRODUCT BENEFITS
<ul style="list-style-type: none"> • Anti-Parallel Diode <ul style="list-style-type: none"> -Switchmode Power Supply -Inverters • Free Wheeling Diode <ul style="list-style-type: none"> -Motor Controllers -Converters • Snubber Diode • Uninterruptible Power Supply (UPS) • Induction Heating • High Speed Rectifiers 	<ul style="list-style-type: none"> • Ultrafast Recovery Times • Soft Recovery Characteristics • Popular SOT-227 Package • Low Forward Voltage • High Blocking Voltage • Low Leakage Current • Avalanche Energy Rated 	<ul style="list-style-type: none"> • Low Losses • Low Noise Switching • Cooler Operation • Higher Reliability Systems • Increased System Power Density

MAXIMUM RATINGS

All Ratings: $T_C = 25^\circ\text{C}$ unless otherwise specified.

Symbol	Characteristic / Test Conditions	APT2x61_60DQ60J	UNIT
V_R	Maximum D.C. Reverse Voltage	600	Volts
V_{RRM}	Maximum Peak Repetitive Reverse Voltage		
V_{RWM}	Maximum Working Peak Reverse Voltage		
$I_{F(AV)}$	Maximum Average Forward Current ($T_C = 92^\circ\text{C}$, Duty Cycle = 0.5)	60	Amps
$I_{F(RMS)}$	RMS Forward Current (Square wave, 50% duty)	79	
I_{FSM}	Non-Repetitive Forward Surge Current ($T_J = 45^\circ\text{C}$, 8.3ms)	600	
E_{AVL}	Avalanche Energy (1A, 40mH)	20	mJ
T_J, T_{STG}	Operating and Storage Temperature Range	-55 to 175	$^\circ\text{C}$

STATIC ELECTRICAL CHARACTERISTICS

Symbol	Characteristic / Test Conditions	MIN	TYP	MAX	UNIT	
V_F	Forward Voltage		$I_F = 60\text{A}$	1.7	2.3	Volts
			$I_F = 120\text{A}$	2.0		
			$I_F = 60\text{A}, T_J = 125^\circ\text{C}$	1.4		
I_{RM}	Maximum Reverse Leakage Current		$V_R = 600\text{V}$		25	μA
			$V_R = 600\text{V}, T_J = 125^\circ\text{C}$		500	
C_T	Junction Capacitance, $V_R = 200\text{V}$		145		pF	

Microsemi Website - <http://www.microsemi.com>

DYNAMIC CHARACTERISTICS

APT2x61_60DQ60J

Symbol	Characteristic	Test Conditions	MIN	TYP	MAX	UNIT
t_{rr}	Reverse Recovery Time	$I_F = 1A, di_F/dt = -100A/\mu s, V_R = 30V, T_J = 25^\circ C$	-	160		ns
t_{rr}	Reverse Recovery Time	$I_F = 60A, di_F/dt = -200A/\mu s, V_R = 400V, T_C = 25^\circ C$	-	70		
Q_{rr}	Reverse Recovery Charge		-	100		nC
I_{RRM}	Maximum Reverse Recovery Current		-	4	-	Amps
t_{rr}	Reverse Recovery Time	$I_F = 60A, di_F/dt = -200A/\mu s, V_R = 400V, T_C = 125^\circ C$	-	140		ns
Q_{rr}	Reverse Recovery Charge		-	690		nC
I_{RRM}	Maximum Reverse Recovery Current		-	9	-	Amps
t_{rr}	Reverse Recovery Time	$I_F = 60A, di_F/dt = -1000A/\mu s, V_R = 400V, T_C = 125^\circ C$	-	80		ns
Q_{rr}	Reverse Recovery Charge		-	1540		nC
I_{RRM}	Maximum Reverse Recovery Current		-	31		Amps

THERMAL AND MECHANICAL CHARACTERISTICS

Symbol	Characteristic / Test Conditions	MIN	TYP	MAX	UNIT
$R_{\theta JC}$	Junction-to-Case Thermal Resistance			.60	$^\circ C/W$
$V_{Isolation}$	RMS Voltage (50-60Hz Sinusoidal Waveform from Terminals to Mounting Base for 1 Min.)	2500			Volts
W_T	Package Weight		1.03		oz
			29.2		g
Torque	Maximum Mounting Torque			10	lb•in
				1.1	N•m

Microsemi reserves the right to change, without notice, the specifications and information contained herein.

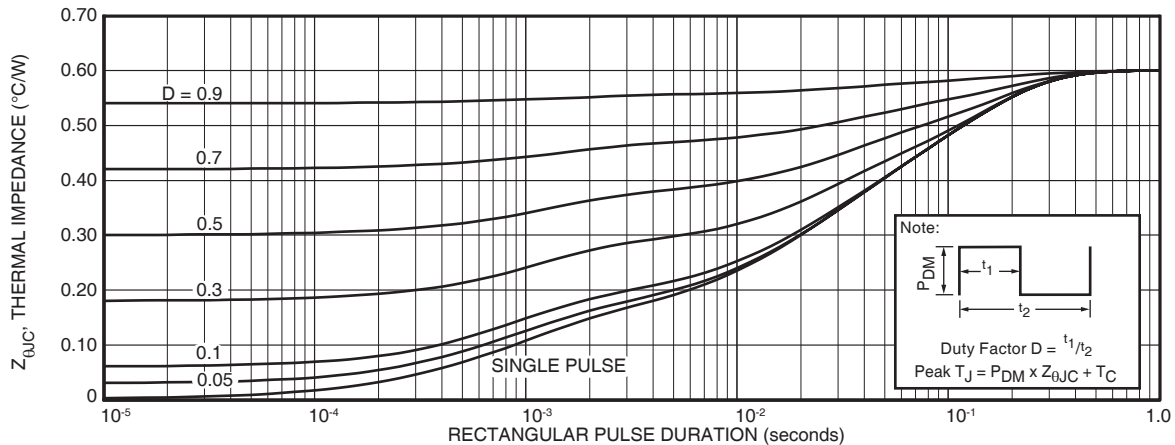
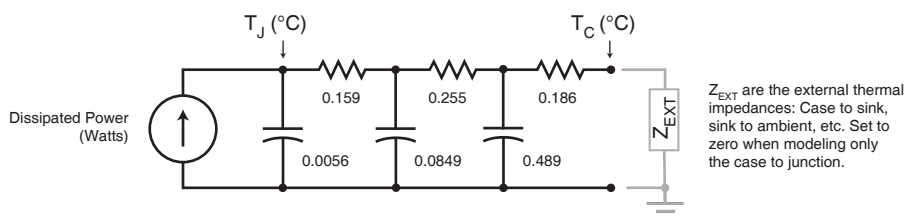

FIGURE 1a. MAXIMUM EFFECTIVE TRANSIENT THERMAL IMPEDANCE, JUNCTION-TO-CASE vs. PULSE DURATION



Z_{EXT} are the external thermal impedances: Case to sink, sink to ambient, etc. Set to zero when modeling only the case to junction.

FIGURE 1b. TRANSIENT THERMAL IMPEDANCE MODEL

TYPICAL PERFORMANCE CURVES

APT2x61_60DQ60J

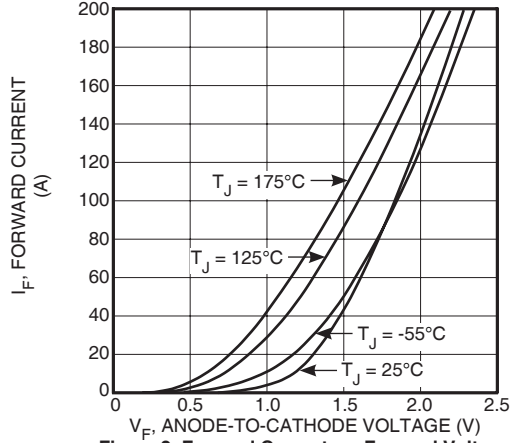

Figure 2. Forward Current vs. Forward Voltage

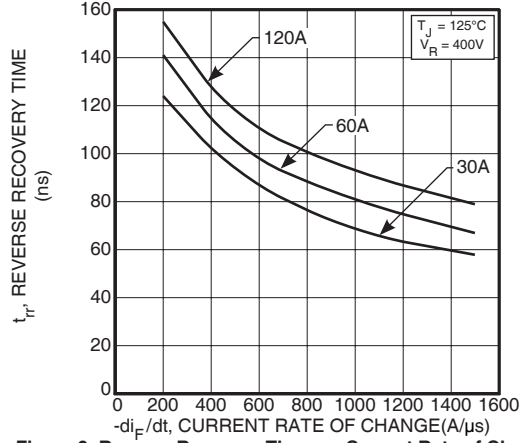

Figure 3. Reverse Recovery Time vs. Current Rate of Change

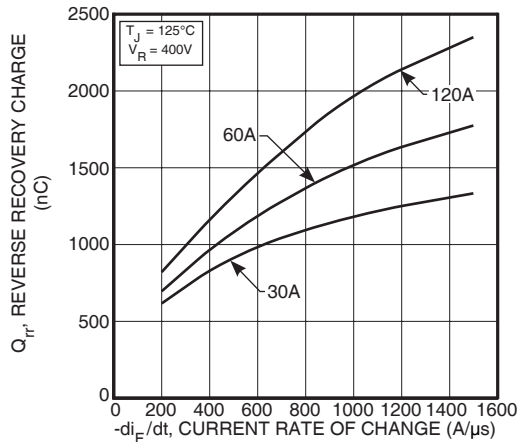

Figure 4. Reverse Recovery Charge vs. Current Rate of Change

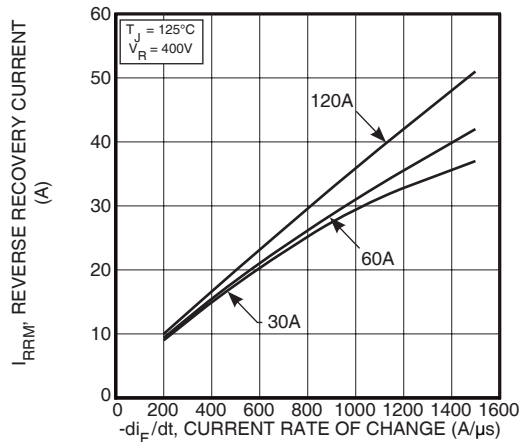

Figure 5. Reverse Recovery Current vs. Current Rate of Change

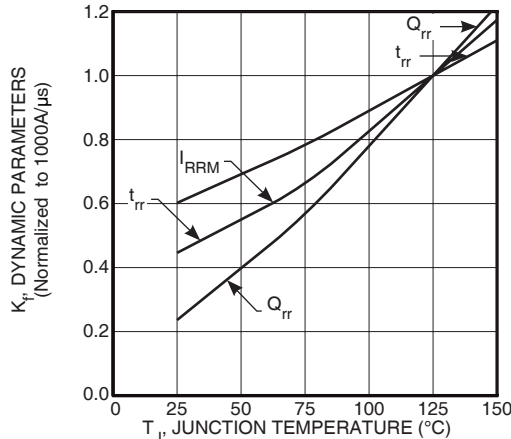

Figure 6. Dynamic Parameters vs. Junction Temperature

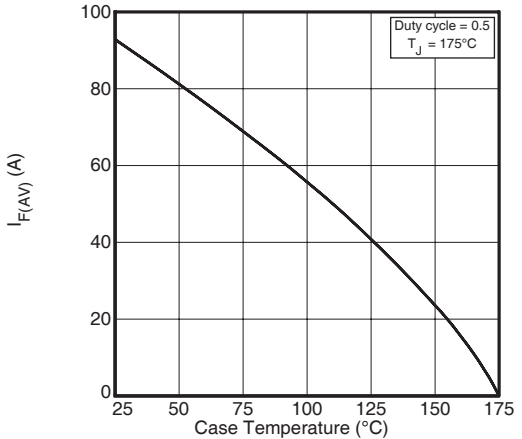

Figure 7. Maximum Average Forward Current vs. Case Temperature

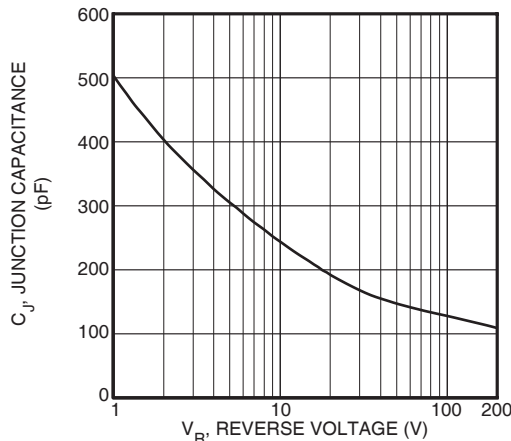

Figure 8. Junction Capacitance vs. Reverse Voltage

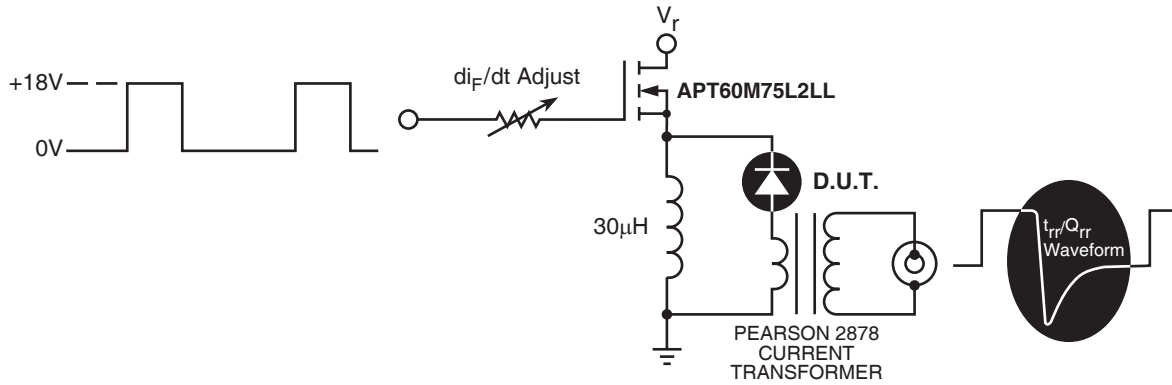

Figure 9. Diode Test Circuit

- 1 I_F - Forward Conduction Current
- 2 di_F/dt - Rate of Diode Current Change Through Zero Crossing.
- 3 I_{RRM} - Maximum Reverse Recovery Current.
- 4 t_{rr} - Reverse Recovery Time, measured from zero crossing where diode current goes from positive to negative, to the point at which the straight line through I_{RRM} and $0.25 \cdot I_{RRM}$ passes through zero.
- 5 Q_{rr} - Area Under the Curve Defined by I_{RRM} and t_{rr} .



Figure 10, Diode Reverse Recovery Waveform and Definitions

SOT-227 (ISOTOP®) Package Outline

