

General Description

The MIC5209 is an efficient linear voltage regulator with very low dropout voltage, typically 10mV at light loads and less than 500mV at full load, with better than 1% output voltage accuracy

Designed especially for hand-held, battery-powered devices, the MIC5209 features low ground current to help prolong battery life. An enable/shutdown pin on SO-8 and TO-263-5 versions can further improve battery life with near-zero shutdown current.

Key features include reversed-battery protection, current limiting, overtemperature shutdown, ultra-low-noise capability (SO-8 and TO-263-5 versions), and availability in thermally-efficient packaging. The MIC5209 is available in adjustable or fixed output voltages.

Datasheets and support documentation are available on Micrel's web site at: www.micrel.com.

Features

- Output voltage range: 1.8V – 5V
- Meets Intel® Slot 1 and Slot 2 requirements
- Guaranteed 500mA output over the full operating temperature range
- Low 500mV maximum dropout voltage at full load
- Extremely tight load and line regulation
- Thermally-efficient surface-mount package
- Low temperature coefficient
- Current and thermal limiting
- Reversed-battery protection
- No-load stability
- 1% output accuracy
- Ultra-low-noise capability in SO-8 and TO-263-5
- Ultra-small 3mm x 3mm DFN package

Applications

- Pentium II Slot 1 and Slot 2 support circuits
- Laptop, notebook, and palmtop computers
- Cellular telephones
- Consumer and personal electronics
- SMPS post-regulator/DC-to-DC modules
- High-efficiency linear power supplies

Typical Application

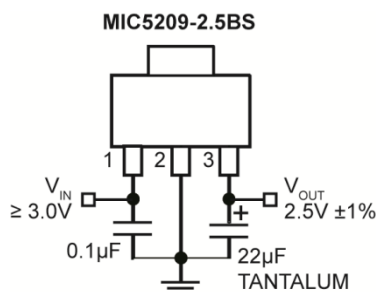

3.3V Nominal Input Slot 1 Power Supply

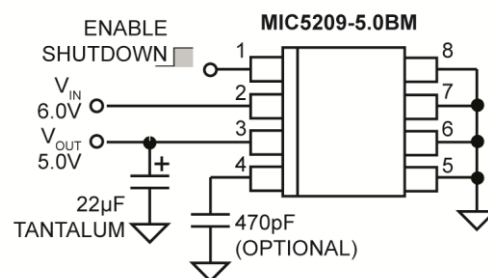

Ultra-Low Noise 5V Regulator

Ordering Information

Part Number	Voltage	Junction Temperature Range	Package	Pb-Free
MIC5209-2.5BS	2.5V	-40°C to +125°C	SOT-223	
MIC5209-2.5YS	2.5V	-40°C to +125°C	SOT-223	X
MIC5209-3.0BS	3.0V	-40°C to +125°C	SOT-223	
MIC5209-3.0YS	3.0V	-40°C to +125°C	SOT-223	X
MIC5209-3.3BS	3.3V	-40°C to +125°C	SOT-223	
MIC5209-3.3YS	3.3V	-40°C to +125°C	SOT-223	X
MIC5209-3.6BS	3.6V	-40°C to +125°C	SOT-223	
MIC5209-3.6YS	3.6V	-40°C to +125°C	SOT-223	X
MIC5209-4.2BS	4.2V	-40°C to +125°C	SOT-223	
MIC5209-4.2YS	4.2V	-40°C to +125°C	SOT-223	X
MIC5209-5.0BS	5.0V	-40°C to +125°C	SOT-223	
MIC5209-5.0YS	5.0V	-40°C to +125°C	SOT-223	X
MIC5209-1.8BM ⁽¹⁾	1.8V	-0°C to +125°C	SOIC-8	
MIC5209-1.8YM ⁽¹⁾	1.8V	-0°C to +125°C	SOIC-8	X
MIC5209-2.5BM	2.5V	-40°C to +125°C	SOIC-8	
MIC5209-2.5YM	2.5V	-40°C to +125°C	SOIC-8	X
MIC5209-3.0BM	3.0V	-40°C to +125°C	SOIC-8	
MIC5209-3.0YM	3.0V	-40°C to +125°C	SOIC-8	X
MIC5209-3.3BM	3.3V	-40°C to +125°C	SOIC-8	
MIC5209-3.3YM	3.3V	-40°C to +125°C	SOIC-8	X
MIC5209-3.6BM	3.6V	-40°C to +125°C	SOIC-8	
MIC5209-3.6YM	3.6V	-40°C to +125°C	SOIC-8	X
MIC5209-5.0BM	5.0V	-40°C to +125°C	SOIC-8	
MIC5209-5.0YM	5.0V	-40°C to +125°C	SOIC-8	X
MIC5209BM	Adjustable (2.5V – 5.0V)	-40°C to +125°C	SOIC-8	
MIC5209YM	Adjustable (2.5V – 5.0V)	-40°C to +125°C	SOIC-8	X
MIC5209-1.8YU ⁽¹⁾	1.8V	-0°C to +125°C	TO-263-5	X
MIC5209-2.5BU	2.5V	-40°C to +125°C	TO-263-5	
MIC5209-2.5YU	2.5V	-40°C to +125°C	TO-263-5	X

Note:

1. Contact Micrel for availability.

Ordering Information (Continued)

Part Number	Voltage	Junction Temperature Range	Package	Pb-Free
MIC5209-3.0BU	3.0V	-40°C to +125°C	TO-263-5	
MIC5209-3.0YU	3.0V	-40°C to +125°C	TO-263-5	X
MIC5209-3.3BU	3.3V	-40°C to +125°C	TO-263-5	
MIC5209-3.3YU	3.3V	-40°C to +125°C	TO-263-5	X
MIC5209-3.6BU	3.6V	-40°C to +125°C	TO-263-5	
MIC5209-3.6YU	3.6V	-40°C to +125°C	TO-263-5	X
MIC5209-5.0BU	5.0V	-40°C to +125°C	TO-263-5	
MIC5209-5.0YU	5.0V	-40°C to +125°C	TO-263-5	X
MIC5209BU	Adjustable (2.5V – 5.0V)	-40°C to +125°C	TO-263-5	
MIC5209YU	Adjustable (2.5V – 5.0V)	-40°C to +125°C	TO-263-5	X
MIC5209YML	Adjustable (2.5V – 5.0V)	-40°C to +125°C	8-Pin DFN	X

Pin Configuration

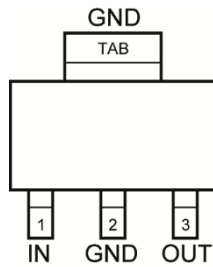

MIC5209-x.xBS
SOT-223
Fixed Voltages

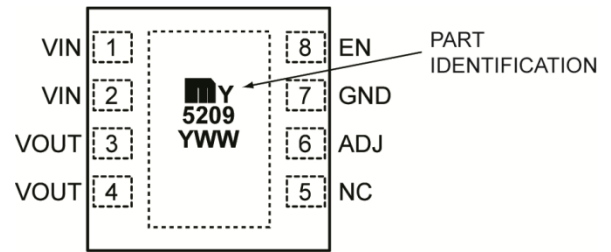

MIC5209YML
8-Pin 3mm x 3mm DFN
Adjustable Voltages

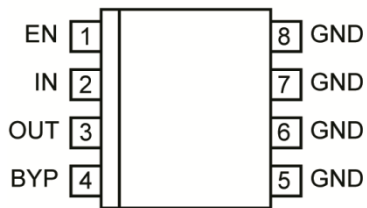

MIC5209-x.xBM
SO-8
Fixed Voltages

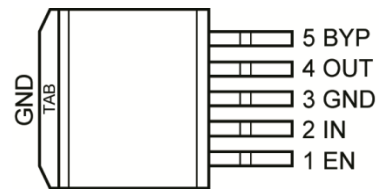

MIC5209-x.xBU
TO-263-5
Fixed Voltages

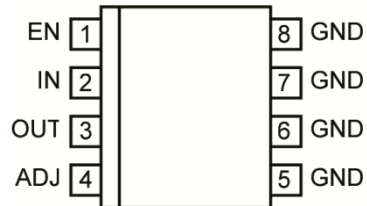

MIC5209BM
SO-8
Adjustable Voltages

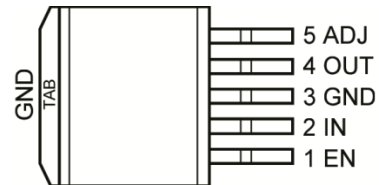

MIC5209BU
TO-263-5
Adjustable Voltages

Pin Description

Pin Number 8-Pin DFN	Pin Number SOT-223	Pin Number SO-8	Pin Number TO-263-5	Pin Name	Pin Function
1, 2	1	2	2	IN	Supply Input.
7	2, TAB	5 – 8	3	GND	Ground: SOT-223 Pin 2 and TAB are internally connected. SO-8 Pins 5 through 8 are internally connected.
3, 4	3	3	4	OUT	Regulator Output: Pins 3 and 4 must be tied together.
8		1	1	EN	Enable (Input): CMOS-compatible control input. Logic High = Enable; Logic Low = Shutdown.
		4 (Fixed)	5 (Fixed)	BYP	Reference Bypass: Connect external 470pF capacitor to GND to reduce output noise. Can be left open. For 1.8V or 2.5V operation, see Application Information .
6		4 (Adjustable)	5 (Adjustable)	ADJ	Adjust (Input): Feedback input. Connect to resistive voltage-divider network.

Absolute Maximum Ratings⁽²⁾

Supply Voltage (V_{IN})	-20V to +20V
Power Dissipation (P_D)	Internally Limited ⁽⁴⁾
Junction Temperature (T_J)	
All Except 1.8V	-40°C to +125°C
1.8V Only	0°C to +125°C
Lead Temperature (soldering, 5s)	260°C
Storage Temperature (T_S)	-65°C to +150°C

Operating Ratings⁽³⁾

Supply Voltage (V_{IN})	+2.5V to +16V
Output Voltage (V_{OUT}) Range	+1.8V to 5.0V
Junction Temperature (T_J)	
2.5V – 5.0V	-40°C to +125°C
1.8V ≤ V_{OUT} < 2.5V	0°C to +125°C
Package Thermal Resistance	Note 4

Electrical Characteristics

$V_{IN} = V_{OUT} + 1V$, $C_{OUT} = 4.7\mu F$, $I_{OUT} = 100\mu A$; $T_J = 25^\circ C$, **bold** values indicate $-40^\circ C \leq T_J \leq +125^\circ C$, except $0^\circ C \leq T_J \leq +125^\circ C$ for $1.8V \leq V_{OUT} < 2.5V$, unless noted.

Symbol	Parameter	Condition	Min.	Typ.	Max.	Units
V_{OUT}	Output Voltage Accuracy	Variation from nominal V_{OUT}	-1		1	%
			-2		2	
$\Delta V_{OUT}/\Delta T$	Output Voltage Temperature Co-Efficient	Note 5		40		ppm/°C
$\Delta V_{OUT}/V_{OUT}$	Line Regulation	$V_{IN} = V_{OUT} + 1V$ to 16V		0.009	0.05	%V
	Load Regulation	$I_{OUT} = 100\mu A$ to 500mA ⁽⁶⁾		0.05	0.5	
$V_{IN} - V_{OUT}$	Dropout Voltage ⁽⁷⁾	$I_{OUT} = 100\mu A$		10	60	mV
				80		
		$I_{OUT} = 50mA$		115	175	
				250		
		$I_{OUT} = 150mA$		165	300	
			350	500		
		$I_{OUT} = 500mA$			600	

Notes:

- Exceeding the absolute maximum ratings may damage the device.
- The device is not guaranteed to function outside its operating ratings.
- The maximum allowable power dissipation at any T_A (ambient temperature) is calculated using: $P_{D(MAX)} = (T_{J(MAX)} - T_A) \theta_{JA}$. Exceeding the maximum allowable power dissipation will result in excessive die temperature, and the regulator will go into thermal shutdown. See [Table 1](#) and the “[Thermal Considerations](#)” sub-section in [Application Information](#) for details.
- Output voltage temperature coefficient is the worst case voltage change divided by the total temperature range.
- Regulation is measured at constant junction temperature using low duty cycle pulse testing. Parts are tested for load regulation in the load range from 100μA to 500mA. Changes in output voltage due to heating effects are covered by the thermal regulation specification.
- Dropout voltage is defined as the input to output differential at which the output voltage drops 2% below its nominal value measured at 1V differential.
- Ground pin current is the regulator quiescent current plus pass transistor base current. The total current drawn from the supply is the sum of the load current plus the ground pin current.
- V_{EN} is the voltage externally applied to devices with the EN (enable) input pin. [SO-8 (M) and TO-263-5 (U) packages only.]

Electrical Characteristics (Continued)

$V_{IN} = V_{OUT} + 1V$, $C_{OUT} = 4.7\mu F$, $I_{OUT} = 100\mu A$; $T_J = 25^\circ C$, **bold** values indicate $-40^\circ C \leq T_J \leq +125^\circ C$, except $0^\circ C \leq T_J \leq +125^\circ C$ for $1.8V \leq V_{OUT} < 2.5V$, unless noted.

Symbol	Parameter	Condition	Min.	Typ.	Max.	Units	
I_{GND}	Ground Pin Current ^(8, 9)	$V_{EN} \geq 3.0V$, $I_{OUT} = 100\mu A$		80	130	μA	
				170			
		$V_{EN} \geq 3.0V$, $I_{OUT} = 50mA$		350	650	mA	
				900			
I_{GND}	Ground Pin Quiescent Current ⁽⁹⁾	$V_{EN} \leq 0.4V$ (Shutdown)		0.05	3	μA	
		$V_{EN} \leq 0.18V$ (Shutdown)		0.10	8		
PSRR	Ripple Rejection	$f = 120Hz$		75		dB	
I_{LIMIT}	Current Limit	$V_{OUT} = 0V$		700	900	mA	
					1000		
$\Delta V_{OUT}/\Delta P_D$	Thermal Regulation	Note 10		0.05		%/W	
e_{NO}	Output Noise ⁽¹¹⁾	$V_{OUT} = 2.5V$, $I_{OUT} = 50mA$ $C_{OUT} = 2.2\mu F$, $C_{BYP} = 0$		500		nV \sqrt{Hz}	
		$I_{OUT} = 50mA$, $C_{OUT} = 2.2\mu F$ $C_{BYP} = 470pF$		300			
V_{ENL}	Enable Input Logic-Low Voltage	$V_{EN} = \text{Logic Low}$ (Regulator Shutdown)			0.4	V	
					0.18		
I_{ENL}	Enable Input Current	$V_{ENL} \leq 0.4V$		0.01	-1	μA	
		$V_{ENL} \leq 0.18V$		0.01	-2		
I_{ENH}		$V_{ENH} \geq 2.0V$		5	20	μA	
					25		
		$V_{ENH} \geq 16V$			30		
					50		

Notes:

10. Thermal regulation is the change in output voltage at a time "t" after a change in power dissipation is applied, excluding load or line regulation effects. Specifications are for a 500mA load pulse at $V_N = 16V$ for $t = 10ms$.

11. C_{BYP} is an optional, external bypass capacitor connected to devices with a BYP (bypass) or ADJ (adjust) pin. [SO-8 (M) and TO-263-5 (U) packages only].

Block Diagrams

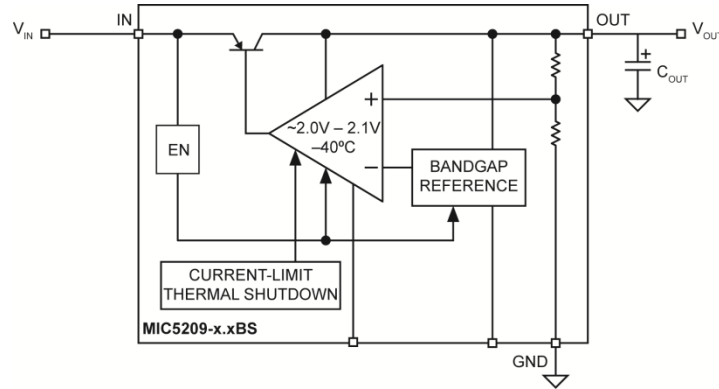

Low-Noise Fixed Regulator (SOT-223 Version Only)

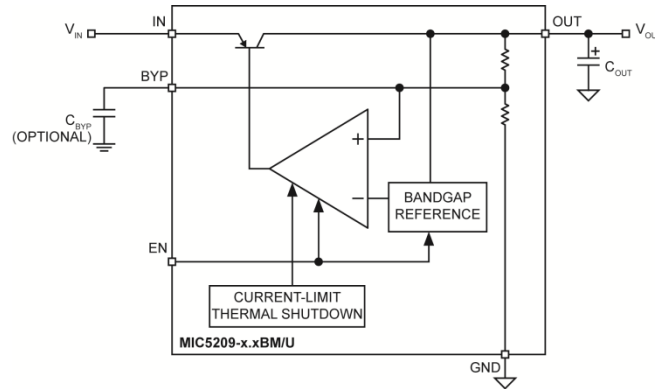

Ultra-Low-Noise Fixed Regulator

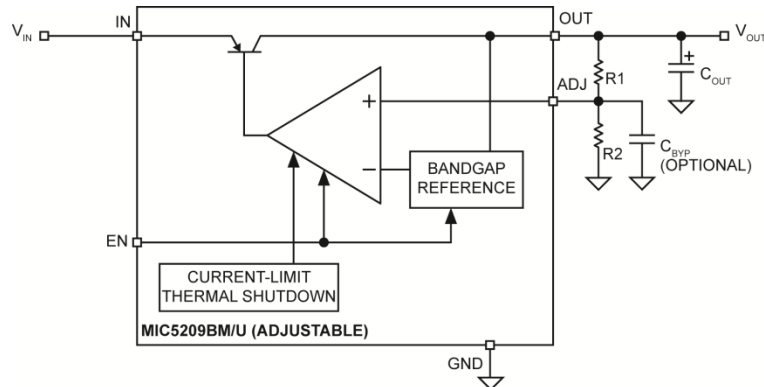

Ultra-Low-Noise Adjustable Regulator

Typical Characteristics

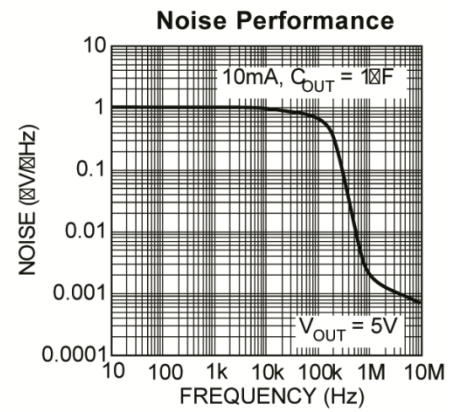
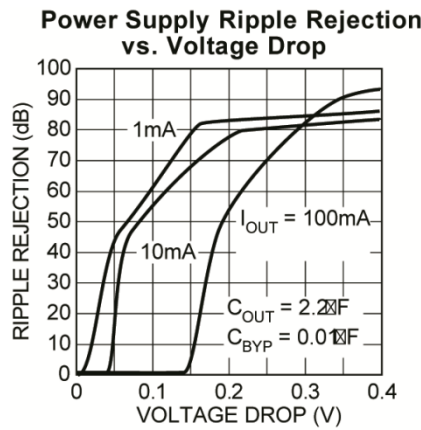
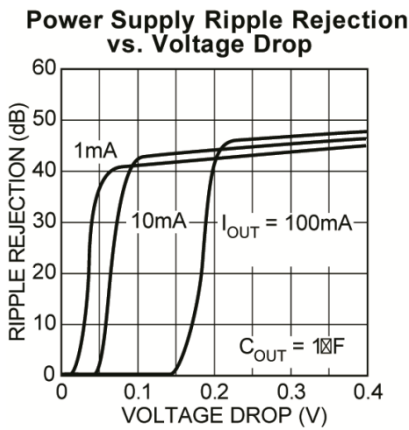
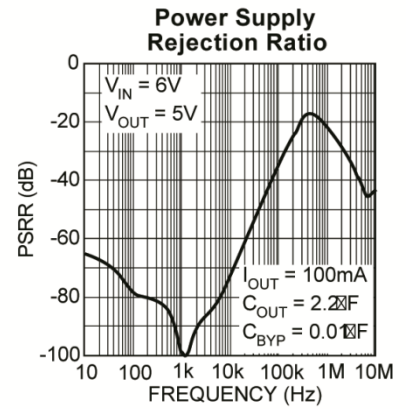
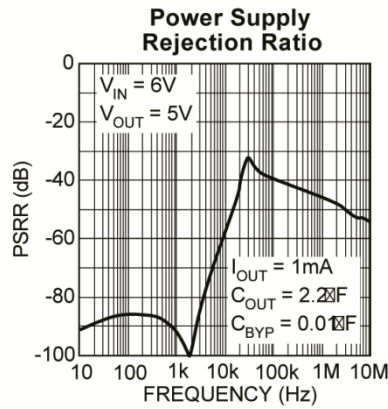
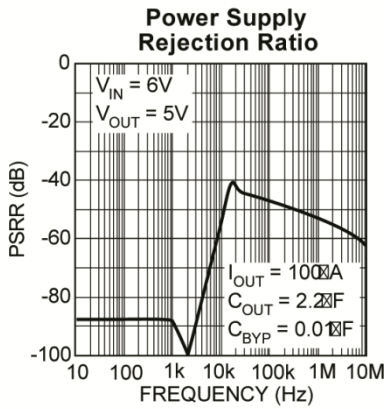
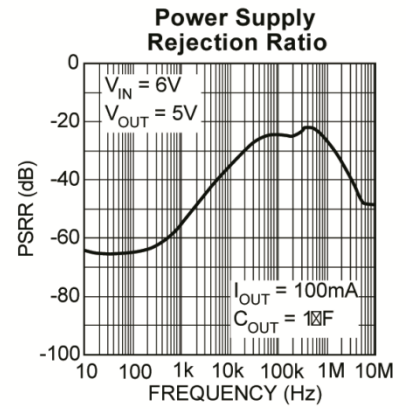
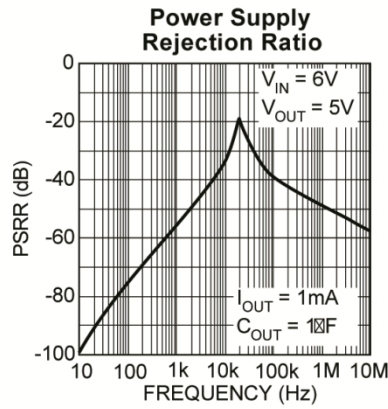
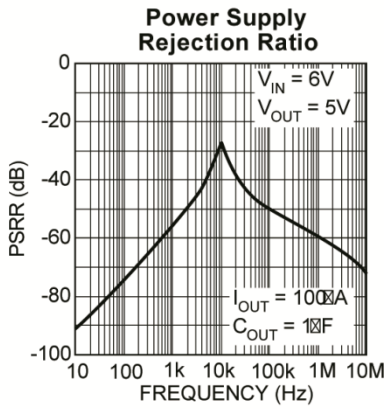

Typical Characteristics (Continued)

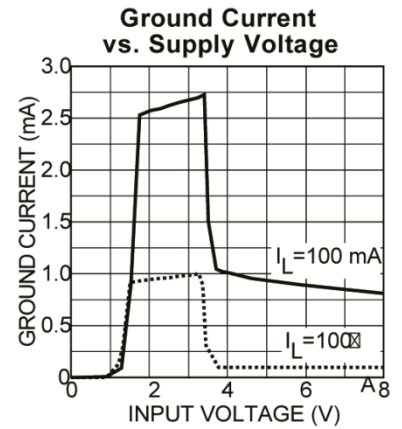
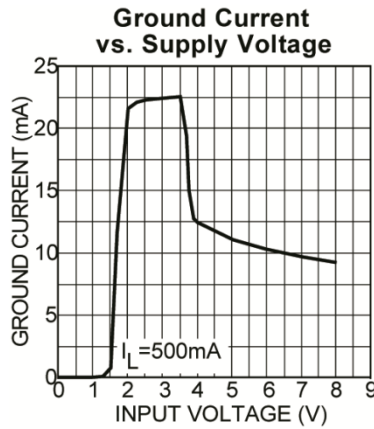
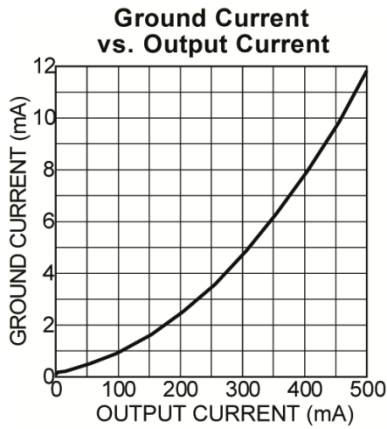
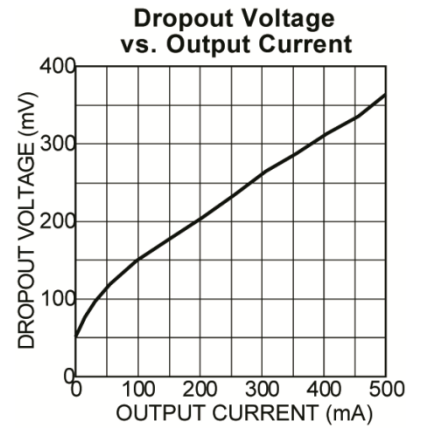
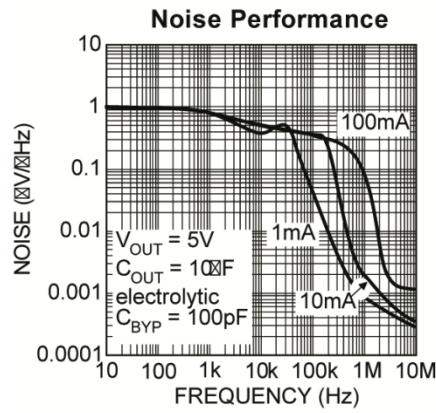
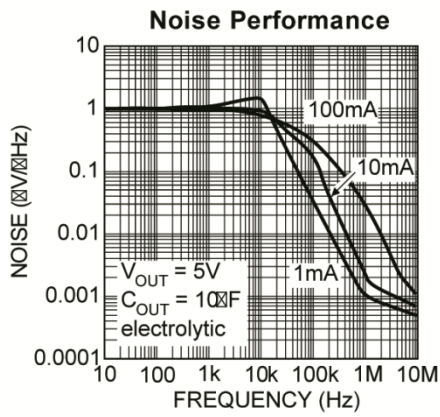

Application Information

Enable Shutdown

Enable is available only on devices in the SO-8 (M) and TO-263-5 (U) packages.

Forcing EN (enable/shutdown) high ($> 2V$) enables the regulator. EN is compatible with CMOS logic. If the enable/shutdown feature is not required, connect EN to IN (supply input).

Input Capacitor

A $1\mu F$ capacitor should be placed from IN to GND if there is more than 10 inches of wire between the input and the AC filter capacitor or if a battery is used as the input.

Output Capacitor

An output capacitor is required between OUT and GND to prevent oscillation. The minimum size of the output capacitor is dependent upon whether a reference bypass capacitor is used. $1\mu F$ minimum is recommended when CBYP is not used (see [Figure 1](#)). $2.2\mu F$ minimum is recommended when CBYP is $470pF$ (see [Figure 2](#)). Larger values improve the regulator's transient response.

The output capacitor should have an ESR (equivalent series resistance) of about 1Ω and a resonant frequency above $1MHz$. Ultra-low-ESR capacitors can cause a low amplitude oscillation on the output and/or underdamped transient response. Most tantalum or aluminum electrolytic capacitors are adequate; film types will work, but are more expensive. Since many aluminum electrolytics have electrolytes that freeze at about $-30^{\circ}C$, solid tantalums are recommended for operation below $-25^{\circ}C$.

At lower values of output current, less output capacitance is needed for output stability. The capacitor can be reduced to $0.47\mu F$ for current below $10mA$ or $0.33\mu F$ for currents below $1mA$.

No-Load Stability

The MIC5209 will remain stable and in regulation with no load (other than the internal voltage divider) unlike many other voltage regulators. This is especially important in CMOS RAM keep-alive applications.

Reference Bypass Capacitor

BYP (reference bypass) is available only on devices in SO-8 and TO-263-5 packages.

BYP is connected to the internal voltage reference. A $470pF$ capacitor (C_{BYP}) connected from BYP to GND quiets this reference, providing a significant reduction in output noise (ultra-low-noise performance). Because C_{BYP} reduces the phase margin, the output capacitor should be increased to at least $2.2\mu F$ to maintain stability.

The start-up speed of the MIC5209 is inversely proportional to the size of the reference bypass capacitor. Applications requiring a slow ramp-up of output voltage should consider larger values of C_{BYP} . Likewise, if rapid turn-on is necessary, consider omitting C_{BYP} .

If output noise is not critical, omit C_{BYP} and leave BYP open.

Thermal Considerations

The SOT-223 has a ground tab which allows it to dissipate more power than the SO-8 (refer to the "[Slot-1 Power Supply](#)" sub-section for details). At $25^{\circ}C$ ambient, it will operate reliably at $2W$ dissipation with "worst-case" mounting (no ground plane, minimum trace widths, and FR4 printed circuit board).

Thermal resistance values for the SO-8 represent typical mounting on a $1"$ -square, copper-clad, FR4 circuit board. For greater power dissipation, SO-8 versions of the MIC5209 feature a fused internal lead frame and die bonding arrangement that reduces thermal resistance when compared to standard SO-8 packages.

Table 1. MIC5209 Thermal Resistance

Package	θ_{JA}	θ_{JC}
SOT-223 (S)	$50^{\circ}C/W$	$8^{\circ}C/W$
SO-8 (M)	$50^{\circ}C/W$	$20^{\circ}C/W$
TO-263-5 (U)	–	$2^{\circ}C/W$
3mm x 3mm DFN (ML)	$63^{\circ}C/W$	$2^{\circ}C/W$

Multilayer boards with a ground plane, wide traces near the pads, and large supply-bus lines will have better thermal conductivity and will also allow additional power dissipation.

For additional heat sink characteristics, refer to Micrel Application Hint 17, [Designing P.C. Board Heat Sinks](#), included in Micrel's Databook. For a full discussion of heat sinking and thermal effects on voltage regulators, refer to the "Regulator Thermals" section of Micrel's [Designing with Low-Dropout Voltage Regulators](#) handbook.

Low-Voltage Operation

The MIC5209-1.8 and MIC5209-2.5 require special consideration when used in voltage-sensitive systems. They may momentarily overshoot their nominal output voltages unless appropriate output and bypass capacitor values are chosen.

During regulator power up, the pass transistor is fully saturated for a short time, while the error amplifier and voltage reference are being powered up more slowly from the output (see *Block Diagrams*). Selecting larger output and bypass capacitors allows additional time for the error amplifier and reference to turn on and prevent overshoot.

To ensure that no overshoot is present when starting up into a light load (100µA), use a 4.7µF output capacitance and 470pF bypass capacitance. This slows the turn-on enough to allow the regulator to react and keep the output voltage from exceeding its nominal value. At heavier loads, use a 10µF output capacitance and 470pF bypass capacitance. Lower values of output and bypass capacitance can be used, depending on the sensitivity of the system.

Applications that can withstand some overshoot on the output of the regulator can reduce the output capacitor and/or reduce or eliminate the bypass capacitor. Applications that are not sensitive to overshoot due to power-on reset delays can use normal output and bypass capacitor configurations.

Please note the junction temperature range of the regulator output less than 2.5V (fixed and adjustable) is 0°C to +125°C.

Fixed Regulator Circuits

Figure 1 shows a basic MIC5209-x.xBM (SO-8) fixed-voltage regulator circuit. See Figure 5 for a similar configuration using the more thermally-efficient MIC5209-x.xBS (SOT-223). A 1µF minimum output capacitor is required for basic fixed- voltage applications.

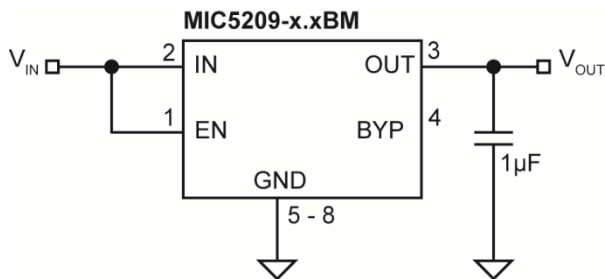

Figure 1. Low-Noise Fixed Voltage Regulator

Figure 2 includes the optional 470pF noise bypass capacitor between BYP and GND to reduce output noise. Note that the minimum value of C_{OUT} must be increased when the bypass capacitor is used.

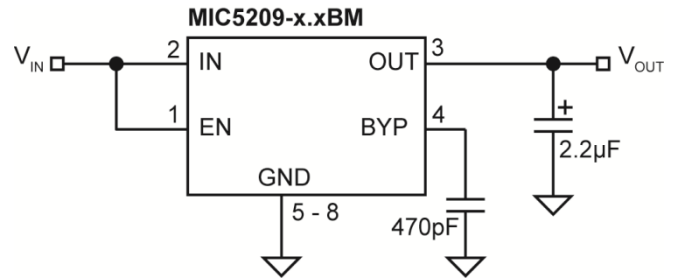

Figure 2. Ultra-Low-Noise Fixed Voltage Regulator

Adjustable Regulator Circuits

The MIC5209BM/U can be adjusted to a specific output voltage by using two external resistors (Figure 3). The resistors set the output voltage based on the equation:

$$V_{OUT} = 1.242V \left(1 + \frac{R2}{R1} \right) \tag{Eq. 1}$$

This equation is correct due to the configuration of the bandgap reference. The bandgap voltage is relative to the output, as seen in the block diagram. Traditional regulators normally have the reference voltage relative to ground; therefore, their equations are different from the equation for the MIC5209BM/U.

Although ADJ is a high-impedance input and, for best performance, R2 should not exceed 470kΩ.

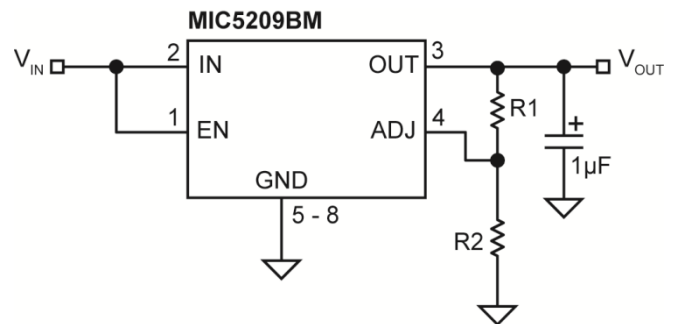

Figure 3. Low-Noise Adjustable Voltage Regulator

Figure 4 includes the optional 470pF bypass capacitor from ADJ to GND to reduce output noise.

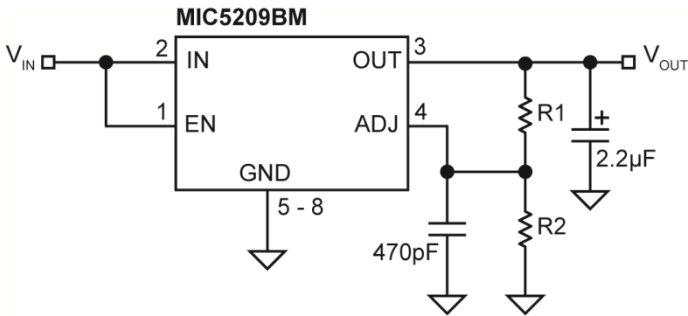

Figure 4. Ultra-Low-Noise Adjustable Application

Slot-1 Power Supply

Intel’s Pentium II processors have a requirement for a 2.5V ±5% power supply for a clock synthesizer and its associated loads. The current requirement for the 2.5V supply is dependent upon the clock synthesizer used, the number of clock outputs, and the type of level shifter (from core logic levels to 2.5V levels). Intel estimates a “worst-case” load of 320mA.

The MIC5209 was designed to provide the 2.5V power requirement for Slot-1 applications. Its guaranteed performance of 2.5V ±3% at 500mA allows adequate margin for all systems, and the dropout voltage of 500mV means that it operates from a “worst-case” 3.3V supply where the voltage can be as low as 3.0V.

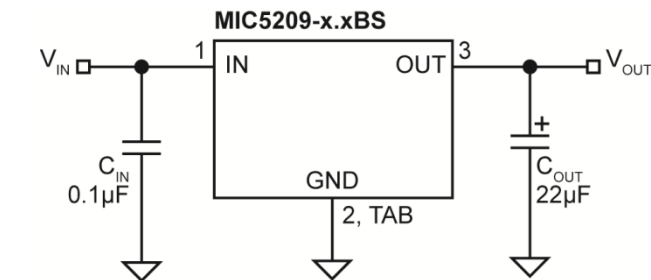

Figure 5. Slot-1 Power Supply

A Slot-1 power supply (Figure 5) is easy to implement. Only two capacitors are necessary, and their values are not critical. C_{IN} bypasses the internal circuitry and should be at least 0.1µF. C_{OUT} provides output filtering, improves transient response, and compensates the internal regulator control loop. Its value should be at least 22µF. C_{IN} and C_{OUT} can be increased as much as desired.

Slot-1 Power Supply Power Dissipation

Powered from a 3.3V supply, the Slot-1 power supply illustrated in Figure 5 has a nominal efficiency of 75%. At the maximum anticipated Slot-1 load (320mA), the nominal power dissipation is only 256mW.

The SOT-223 package has sufficient thermal characteristics for wide design margins when mounted on a single-layer copper-clad printed circuit board. The power dissipation of the MIC5209 is calculated using the voltage drop across the device output current plus supply voltage ground current.

Considering “worst-case” tolerances, the power dissipation could be as high as:

$$\begin{aligned}
 &(V_{IN(MAX)} - V_{OUT(MAX)}) \times I_{OUT} + V_{IN(MAX)} \times I_{GND} \\
 &[(3.6V - 2.375V) \times 320mA] + (3.6V \times 4mA) \\
 &P_D = 407mW
 \end{aligned}$$

Using the maximum junction temperature of 125°C and a θ_{JC} of 8°C/W for the SOT-223, 25°C/W for the SO-8, or 2°C/W for the TO-263 package, the following worst-case heat-sink thermal resistance (θ_{SA}) requirements are:

$$\begin{aligned}
 \theta_{JA} &= \frac{T_{J(MAX)} - T_A}{P_D} \\
 \theta_{SA} &= \theta_{JA} = \theta_{JC}
 \end{aligned}$$

Table 2 and Figure 6 show that the Slot-1 power supply application can be implemented with a minimum footprint layout.

Table 2. Maximum Allowable Thermal Resistance

T _A	40°C	50°C	60°C	75°C
θ _{JA} (Limit)	209°C/W	184°C/W	160°C/W	123°C/W
θ _{SA} SOT-223	201°C/W	176°C/W	152°C/W	115°C/W
θ _{SA} SO-8	184°C/W	159°C/W	135°C/W	98°C/W
θ _{SA} TO-263-5	207°C/W	182°C/W	158°C/W	121°C/W

Figure 6 shows the necessary copper pad area to obtain specific heatsink thermal resistance (θ_{SA}) values. The θ_{SA} values highlighted in Table 2 require much less than 500mm² of copper and, per Figure 6, can be easily accomplished with the minimum footprint.

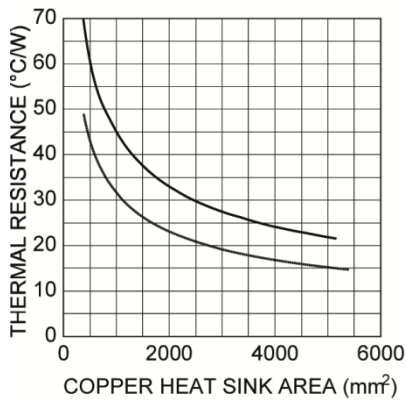
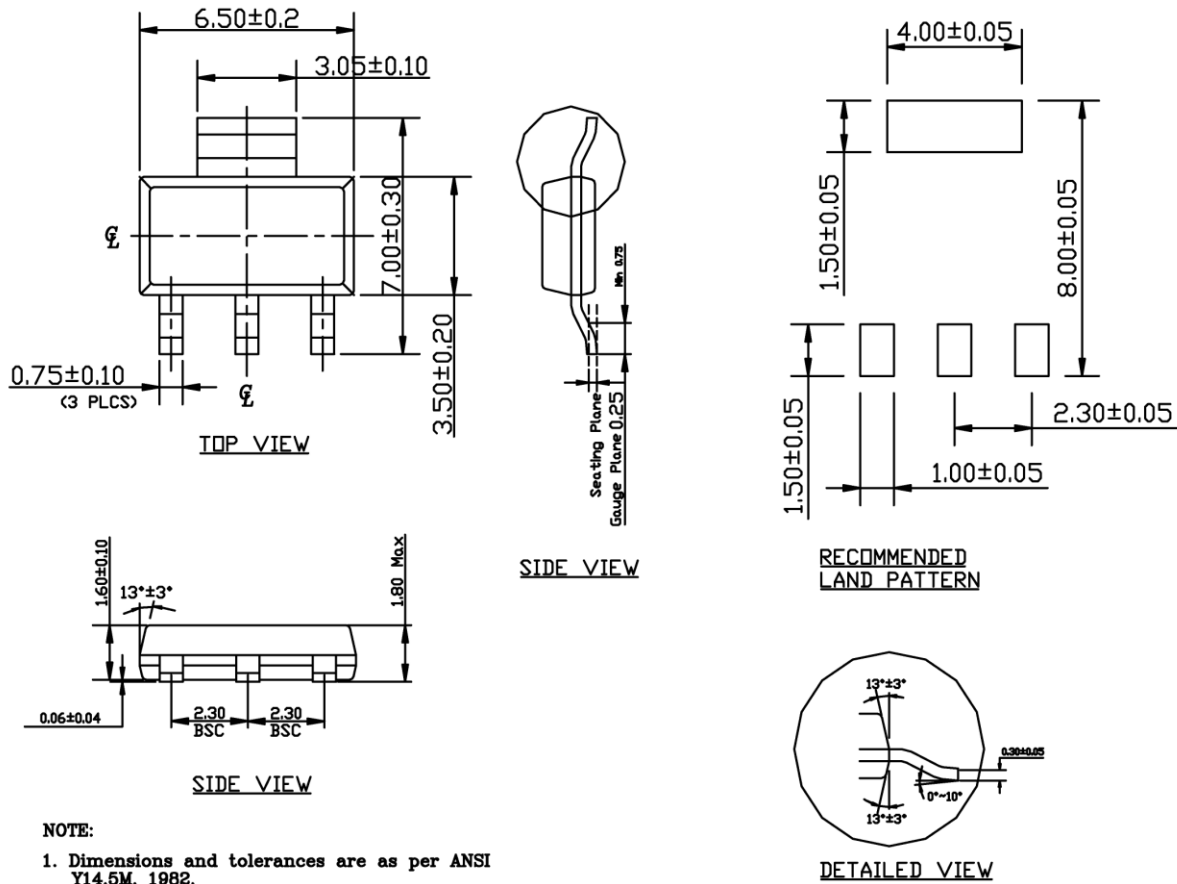

Figure 6. PCB Heatsink Thermal Resistance

Package Information⁽¹²⁾



NOTE:

1. Dimensions and tolerances are as per ANSI Y14.5M, 1982.
2. Controlling dimension: Millimeters.
3. Dimensions are exclusive of mold flash and gate burr.
4. All specification comply to Jedec spec TO261 Issue C.

SOT-223 (S)

Note:

12. Package information is correct as of the publication date. For updates and most current information, go to www.micrel.com.

Package Information⁽¹²⁾ (Continued)

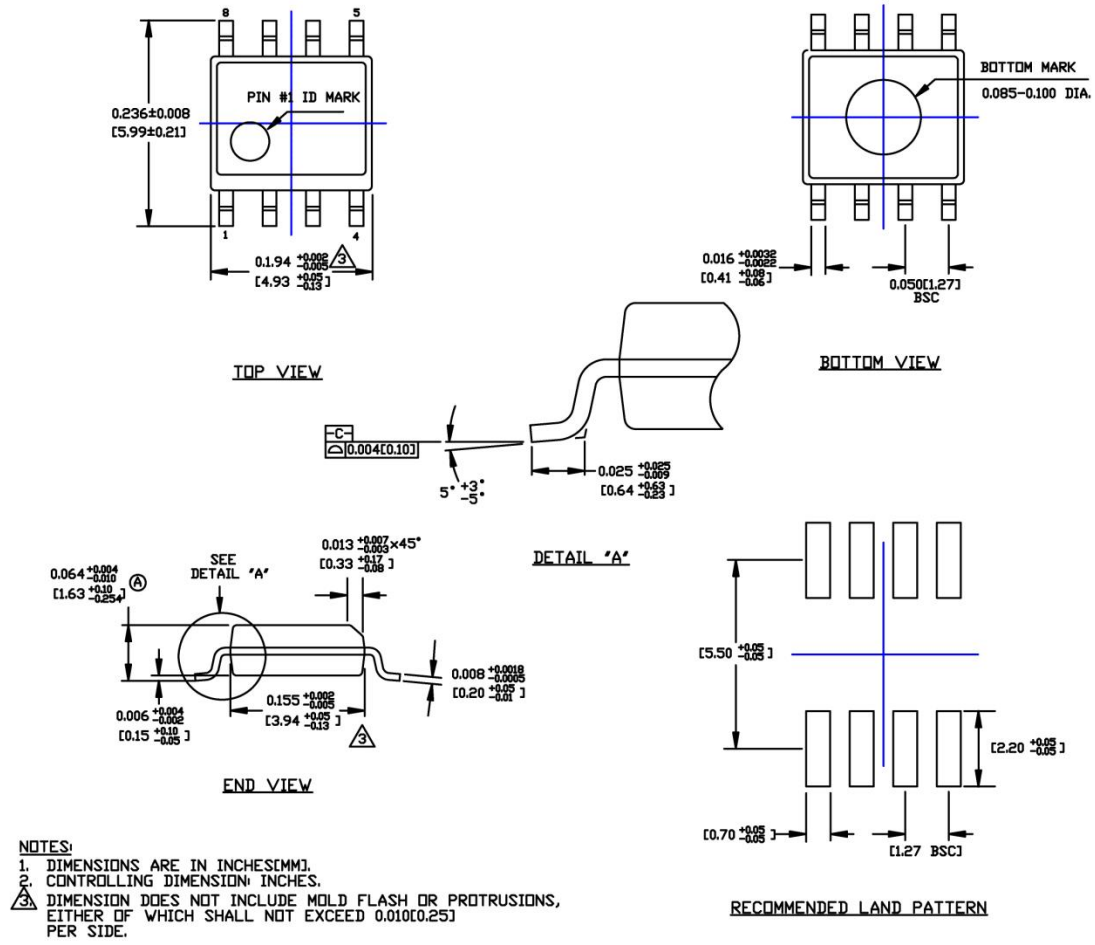

8-Pin SOIC (M)

Package Information⁽¹²⁾ (Continued)

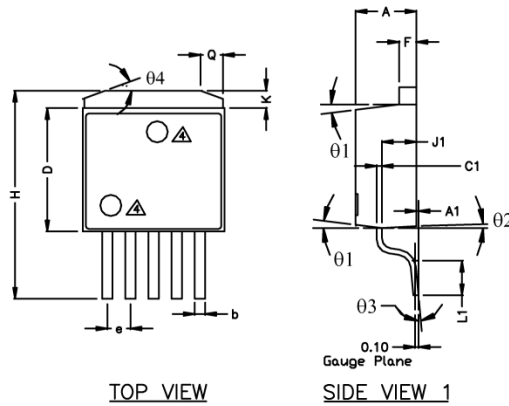

TOP VIEW

SIDE VIEW 1

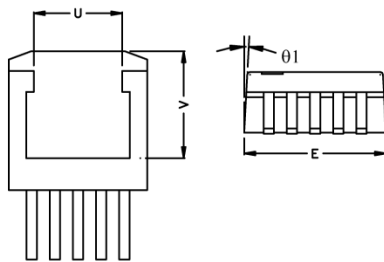

BOTTOM VIEW

SIDE VIEW 2

POS	INCH		MM	
	MIN	MAX	MIN	MAX
A	0.170	0.181	4.318	4.597
A1	0.000	0.012	0.000	0.305
b	0.026	0.036	0.660	0.914
C1	0.012	0.023	0.305	0.584
D	0.330	0.361	8.392	9.169
E	0.396	0.420	10.058	10.668
e	0.062	0.072	1.575	1.829
F	0.045	0.055	1.143	1.397
H	0.575	0.625	14.605	15.875
J1	0.080	0.120	2.032	3.048
K	0.045	0.066	1.143	1.676
L1	0.090	0.110	2.286	2.794
θ1	3°	10°	3°	10°
θ2	1°	7°	1°	7°
θ3	0°	8°	0°	8°
θ4	18°	22°	18°	22°
Q	0.055	0.075	1.397	1.905
U	0.256	Ref.	6.502	Ref.
V	0.305	Ref.	7.747	Ref.

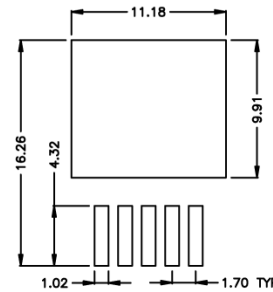

RECOMMENDED LAND PATTERN
(UNIT : mm)

- NOTE:
1. PACKAGE OUTLINE EXCLUSIVE OF MOLD FLASH & METAL BURR.
 2. PACKAGE OUTLINE INCLUSIVE OF PLATING THICKNESS.
 3. FOOT LENGTH USING GAUGE PLANE METHOD MEASUREMENT 0.010"
 4. PACKAGE TOP MARK MAY BE IN TOP CENTER OR LOWER LEFT CORNER
 5. ALL DIMENSIONS ARE IN INCHES/MILLIMETERS.

TO-263-5 (U)

Package Information⁽¹²⁾ (Continued)

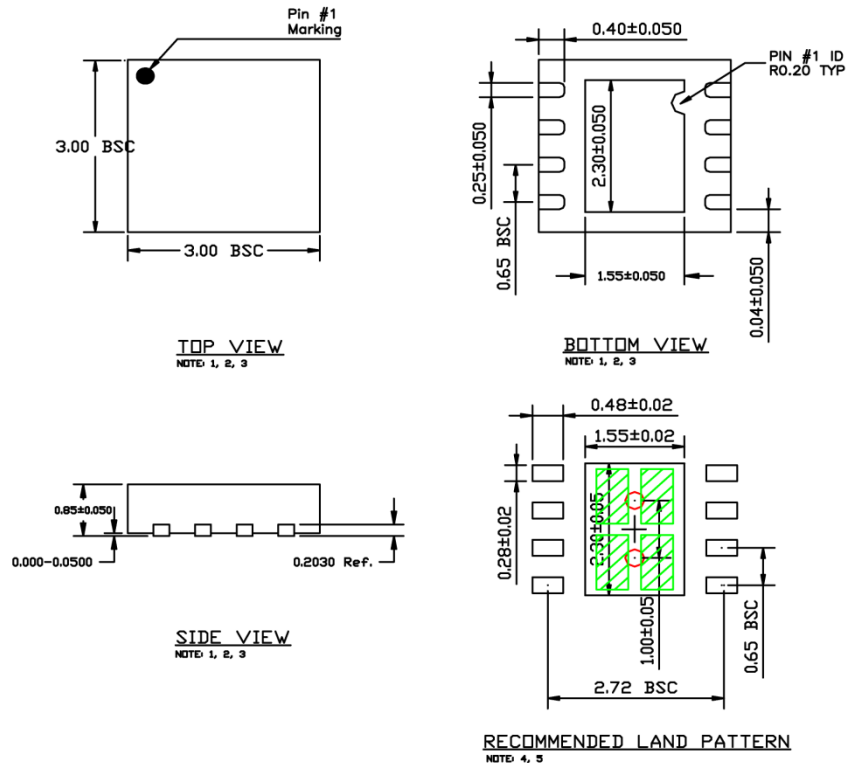

NOTE:

1. MAX PACKAGE WARPAGE IS 0.05 MM
2. MAX ALLOWABLE BURR IS 0.076MM IN ALL DIRECTIONS
3. PIN #1 IS ON TOP WILL BE LASER MARKED
4. RED CIRCLE IN LAND PATTERN INDICATE THERMAL VIA. SIZE SHOULD BE 0.30-0.3MM IN DIAMETER AND SHOULD BE CONNECTED TO GND FOR MAX THERMAL PERFORMANCE
5. GREEN RECTANGLES (SHADED AREA) INDICATE SOLDER STENCIL OPENING ON EXPOSED PAD AREA. SIZE SHOULD BE 0.50x0.95 MM IN SIZE, 0.20 MM SPACING.

8-Pin 3mm x 3mm DFN (ML)

MICREL, INC. 2180 FORTUNE DRIVE SAN JOSE, CA 95131 USA
 TEL +1 (408) 944-0800 FAX +1 (408) 474-1000 WEB <http://www.micrel.com>

Micrel makes no representations or warranties with respect to the accuracy or completeness of the information furnished in this data sheet. This information is not intended as a warranty and Micrel does not assume responsibility for its use. Micrel reserves the right to change circuitry, specifications and descriptions at any time without notice. No license, whether express, implied, arising by estoppel or otherwise, to any intellectual property rights is granted by this document. Except as provided in Micrel's terms and conditions of sale for such products, Micrel assumes no liability whatsoever, and Micrel disclaims any express or implied warranty relating to the sale and/or use of Micrel products including liability or warranties relating to fitness for a particular purpose, merchantability, or infringement of any patent, copyright or other intellectual property right.

Micrel Products are not designed or authorized for use as components in life support appliances, devices or systems where malfunction of a product can reasonably be expected to result in personal injury. Life support devices or systems are devices or systems that (a) are intended for surgical implant into the body or (b) support or sustain life, and whose failure to perform can be reasonably expected to result in a significant injury to the user. A Purchaser's use or sale of Micrel Products for use in life support appliances, devices or systems is a Purchaser's own risk and Purchaser agrees to fully indemnify Micrel for any damages resulting from such use or sale.

© 2014 Micrel, Incorporated.