

Radiation Hardened P-Channel MOSFET

Qualified per MIL-PRF-19500/630

*Qualified Levels:
JANSR and JANSF*

DESCRIPTION

Microsemi's first generation Rad- Hard MOSFET's are designed for Space and Military applications. The devices have been characterized for Total Dose (TID) and Single Event environments (SEE). These products may be used for satellite Power Supplies, Motor Controls and any miscellaneous power applications needed for Space. Microsemi's Rad- hard MOSFET's are qualified to MIL-PRF- 19500 slash sheet specifications. The 2N7389 is qualified to meet Slash Sheet /630 of MIL-PRF-19500.

Important: For the latest information, visit our website <http://www.microsemi.com>.

FEATURES

- JEDEC registered 2N7389 number
- Hermetically sealed package
- Internal metallurgical bonds
- RHA level JANS qualifications available per MIL-PRF-19500/630.
(See [part nomenclature](#) for all available options.)

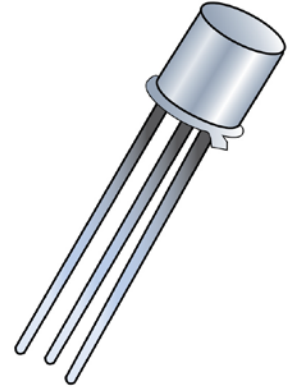

TO-205AF
(formerly TO-39)
Package

APPLICATIONS / BENEFITS

- Leaded TO-205AF package
- Lightweight package
- Military and other high-reliability rad-hard applications

Also available in:

U-18 LCC Package
(surface mount)
 [JANS 2N7389U](#)

MAXIMUM RATINGS @ T_C = +25 °C unless otherwise stated

Parameters / Test Conditions	Symbol	Value	Unit
Operating & Storage Junction Temperature Range	T _J & T _{stg}	-55 to +150	°C
Thermal Resistance Junction-to-Case (see Figure 4)	R _{θJC}	5	°C/W
Total Power Dissipation	P _T	0.8 25	W
		@ T _A = +25 °C	
		@ T _C = +25 °C ⁽¹⁾	
Gate-Source Voltage, dc	V _{GS}	± 20	V
Drain Current, dc @ T _C = +25 °C ⁽²⁾ ⁽³⁾	I _{D1}	-6.5	A
Drain Current, dc @ T _C = +100 °C ⁽²⁾ ⁽³⁾	I _{D2}	-4.1	A
Off-State Current (Peak Total Value) ⁽⁴⁾	I _{DM}	-26	A
Source Current	I _S	-6.5	A

- NOTES:**
1. Derated linearly 0.2 W/°C for T_C > +25 °C
 2. The following formula derives the maximum theoretical I_D limit. I_D is limited by package and internal wires and may also be limited by pin diameter:

$$I_D = \sqrt{\frac{T_J(\max) - T_C}{R_{\theta JC} \times r_{DS(on)} @ T_J(\max)}}$$

3. See [Figure 3](#) for maximum drain current graphs
4. I_{DM} = 4 X I_{D1} as calculated in note (2)

MSC – Lawrence

6 Lake Street,
Lawrence, MA 01841
Tel: 1-800-446-1158 or
(978) 620-2600
Fax: (978) 689-0803

MSC – Ireland

Gort Road Business Park,
Ennis, Co. Clare, Ireland
Tel: +353 (0) 65 6840044
Fax: +353 (0) 65 6822298

Website:

www.microsemi.com

MECHANICAL and PACKAGING

- CASE: Hermetically sealed, kovar base, nickel cap
- TERMINALS: Leads are gold plated and solder dipped over steel
- MARKING: Part number, date code, manufacturer's ID
- WEIGHT: Approximately 1.064 grams
- See [Package Dimensions](#) on last page.

PART NOMENCLATURE

JANSR 2N7389

Reliability Level
JEDEC type number

JANSR = 100K Rads (Si) _____
 JANSF = 300K Rads (Si) _____

SYMBOLS & DEFINITIONS

Symbol	Definition
di/dt	Rate of change of diode current while in reverse-recovery mode, recorded as maximum value.
I_D	Drain Current, dc: The direct current into the drain terminal.
I_{DSS}	Zero-Gate-Voltage Drain Current: The direct current into the gate terminal when the gate-source voltage is zero.
I_F	Forward Current: The current flowing from the p-type region to the n-type region.
I_{GSS}	Reverse-Gate Current, Drain Short-Circuited to Source: The direct current into the gate terminal with a forward gate source voltage applied (I_{GSSF}) or reverse gate source voltage applied (I_{GSSF}) and the drain terminal short-circuited to the source terminal.
I_S	Source Current, dc: The direct current into the source terminal.
$r_{DS(on)}$	Static Drain-Source On-State Resistance: The dc resistance between the drain and source terminals with a specified gate-source voltage applied to bias the device to the on state.
R_G	Gate Drive Impedance or Gate Resistance.
$V_{(BR)DSS}$	Drain-Source Breakdown Voltage: Gate short-circuited to the source terminal.
V_{DD}	Drain-Supply Voltage, dc: The dc supply voltage applied to a circuit connected to the drain terminal.
V_{DG}	Drain-Gate Voltage, dc: The dc voltage between the drain and gate terminals.
V_{DS}	Drain-Source Voltage, dc: The dc voltage between the drain terminal and the source terminal.
$V_{DS(on)}$	Drain-Source On-State Voltage: The voltage between the drain and source terminals with a specified forward gate-source voltage supplied to bias the device to the on-state.
V_{GS}	Gate-Source Voltage, dc: The dc voltage between the gate terminal and the source terminal.

ELECTRICAL CHARACTERISTICS @ $T_A = +25^\circ\text{C}$, unless otherwise noted

Parameters / Test Conditions	Symbol	Min.	Max.	Unit
PRE-IRRADIATION CHARACTERISTICS				
Drain-Source Breakdown Voltage $V_{GS} = 0\text{ V}, I_D = -1.0\text{ mA}$	$V_{(BR)DSS}$	-100		V
Gate-Source Voltage (Threshold) $V_{DS} \geq V_{GS}, I_D = -1\text{ mA}$ $V_{DS} \geq V_{GS}, I_D = -1\text{ mA}, T_J = +125^\circ\text{C}$ $V_{DS} \geq V_{GS}, I_D = -1\text{ mA}, T_J = -55^\circ\text{C}$	$V_{GS(th)1}$ $V_{GS(th)2}$ $V_{GS(th)3}$	-2.0 -1.0	-4.0 -5.0	V
Gate Current $V_{GS} = \pm 20\text{ V}, V_{DS} = 0\text{ V}$ $V_{GS} = \pm 20\text{ V}, V_{DS} = 0\text{ V}, T_J = +125^\circ\text{C}$	I_{GSS1} I_{GSS2}		± 100 ± 200	nA
Drain Current $V_{GS} = 0\text{ V}, V_{DS} = -80\text{ V}$	I_{DSS1}		-25	μA
Drain Current $V_{GS} = 0\text{ V}, V_{DS} = -80\text{ V}, T_J = +125^\circ\text{C}$	I_{DSS2}		-0.25	mA
Static Drain-Source On-State Resistance $V_{GS} = -12\text{ V}, I_D = -4.1\text{ A}$ pulsed	$r_{DS(on)1}$		0.30	Ω
Static Drain-Source On-State Resistance $V_{GS} = -12\text{ V}, I_D = -6.5\text{ A}$ pulsed	$r_{DS(on)2}$		0.35	Ω
Static Drain-Source On-State Resistance $T_J = +125^\circ\text{C}$ $V_{GS} = -12\text{ V}, I_D = -4.1\text{ A}$ pulsed	$r_{DS(on)3}$		0.54	Ω
Diode Forward Voltage $V_{GS} = 0\text{ V}, I_D = -6.5\text{ A}$ pulsed	V_{SD}		-3.0	V

DYNAMIC CHARACTERISTICS

Parameters / Test Conditions	Symbol	Min.	Max.	Unit
Gate Charge:				
On-State Gate Charge $V_{GS} = -12\text{ V}, I_D = -6.5\text{ A}, V_{DS} = -50\text{ V}$	$Q_{g(on)}$		45	nC
Gate to Source Charge $V_{GS} = -12\text{ V}, I_D = -6.5\text{ A}, V_{DS} = -50\text{ V}$	Q_{gs}		10	nC
Gate to Drain Charge $V_{GS} = -12\text{ V}, I_D = -6.5\text{ A}, V_{DS} = -50\text{ V}$	Q_{gd}		25	nC

SWITCHING CHARACTERISTICS

Parameters / Test Conditions	Symbol	Min.	Max.	Unit
Turn-on delay time $I_D = -6.5\text{ A}, V_{GS} = -12\text{ V}, R_G = 7.5\ \Omega, V_{DD} = -50\text{ V}$	$t_{d(on)}$		30	ns
Rise time $I_D = -6.5\text{ A}, V_{GS} = -12\text{ V}, R_G = 7.5\ \Omega, V_{DD} = -50\text{ V}$	t_r		50	ns
Turn-off delay time $I_D = -6.5\text{ A}, V_{GS} = -12\text{ V}, R_G = 7.5\ \Omega, V_{DD} = -50\text{ V}$	$t_{d(off)}$		70	ns
Fall time $I_D = -6.5\text{ A}, V_{GS} = -12\text{ V}, R_G = 7.5\ \Omega, V_{DD} = -50\text{ V}$	t_f		70	ns
Diode Reverse Recovery Time $di/dt \leq -100\text{ A}/\mu\text{s}, V_{DD} \leq -50\text{ V}, I_F = -6.5\text{ A}$	t_{rr}		250	ns

ELECTRICAL CHARACTERISTICS @ $T_A = +25^\circ\text{C}$, unless otherwise noted (continued)
POST-IRRADIATION ⁽¹⁾

Parameters / Test Conditions	Symbol	Min.	Max.	Unit
Drain-Source Breakdown Voltage $V_{GS} = 0\text{ V}, I_D = -1\text{ mA}$	$V_{(BR)DSS}$	-100		V
Gate-Source Voltage (Threshold) $V_{DS} \geq V_{GS}, I_D = -1.0\text{ mA}$ JANSR $V_{DS} \geq V_{GS}, I_D = -1.0\text{ mA}$ JANSF	$V_{GS(th)1}$ $V_{GS(th)1}$	-2.0 -2.0	-4.0 -5.0	V
Gate Current $V_{GS} = \pm 20\text{ V}, V_{DS} = 0\text{ V}$	I_{GSS1}		± 100	nA
Drain Current $V_{GS} = 0\text{ V}, V_{DS} = -80\text{ V}$ of V_{DS} (pre-irradiated)	I_{DSS1}		-25	μA
Static Drain-Source On-State Voltage $V_{GS} = -12\text{ V}, I_D = -4.1\text{ pulsed}$	$r_{DS(on)}$		1.23	V
Diode Forward Voltage $V_{GS} = 0\text{ V}, I_D = -6.5\text{ pulsed}$	V_{SD}		-3.0	V

NOTE: 1. Post-irradiation electrical characteristics apply to devices subjected to steady state total dose irradiation testing in accordance with MIL-STD-750, method 1019. Separate samples are tested for V_{GS} bias (12V), and V_{DS} bias (80V) conditions.

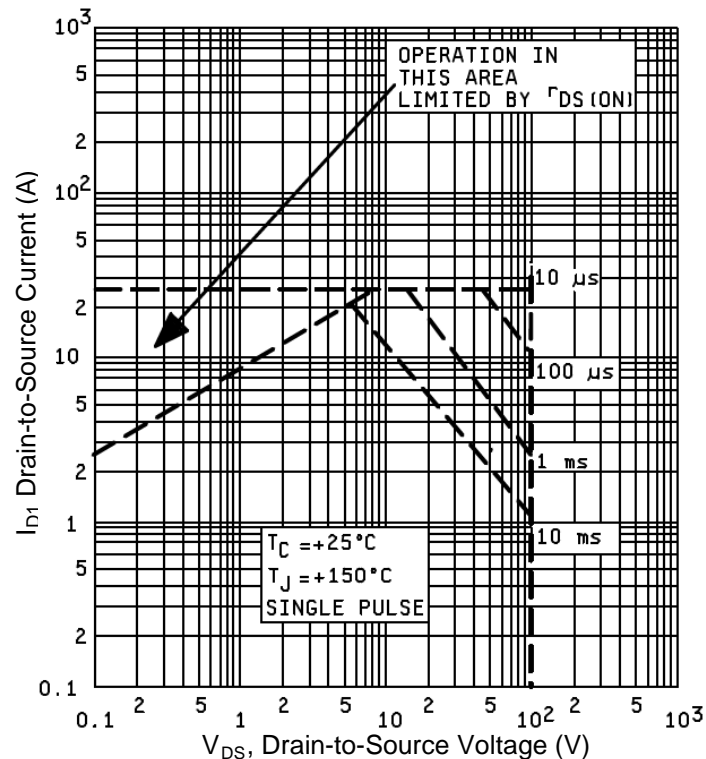
SAFE OPERATING AREA

FIGURE 1

GRAPHS
SEE (Single Event Effect) Typical Response:

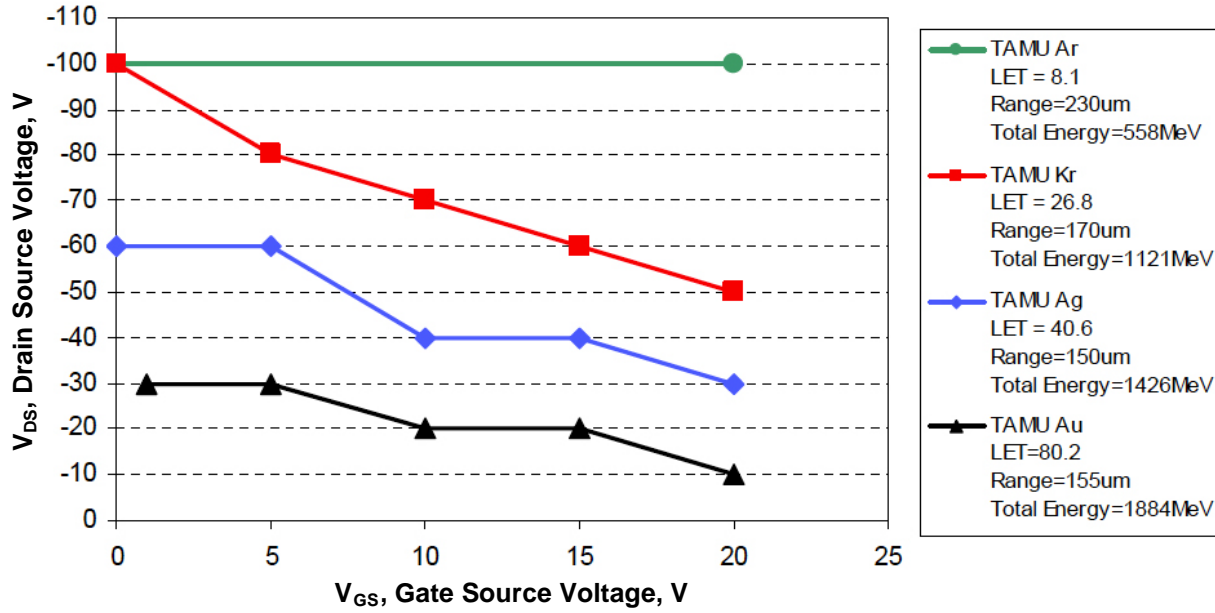
Heavy Ion testing of the 2N7389 device has been characterized at the Texas A&M cyclotron. The following SEE curve has been established using the elements, LET, range, and Total Energy conditions as shown:

FIGURE 2

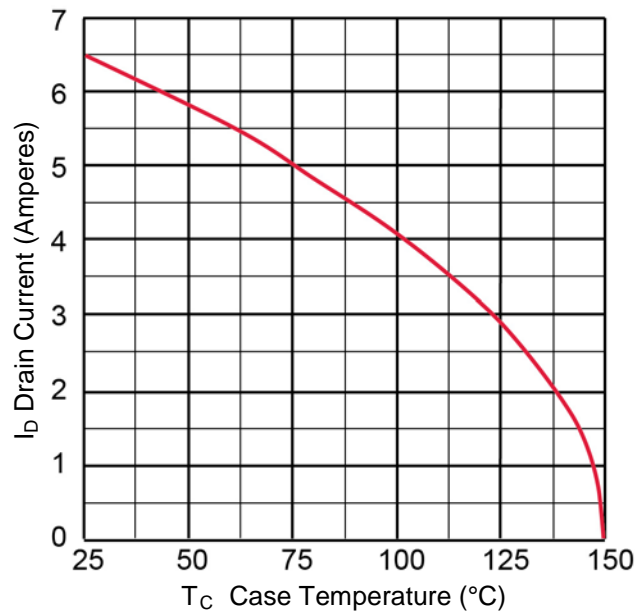
It should be noted that total energy levels are considered to be a factor in SEE characterization. Comparisons to other datasets should not be based on LET alone. Please consult factory for more information.

FIGURE 3

Maximum Drain Current vs Case Temperature

GRAPHS (continued)

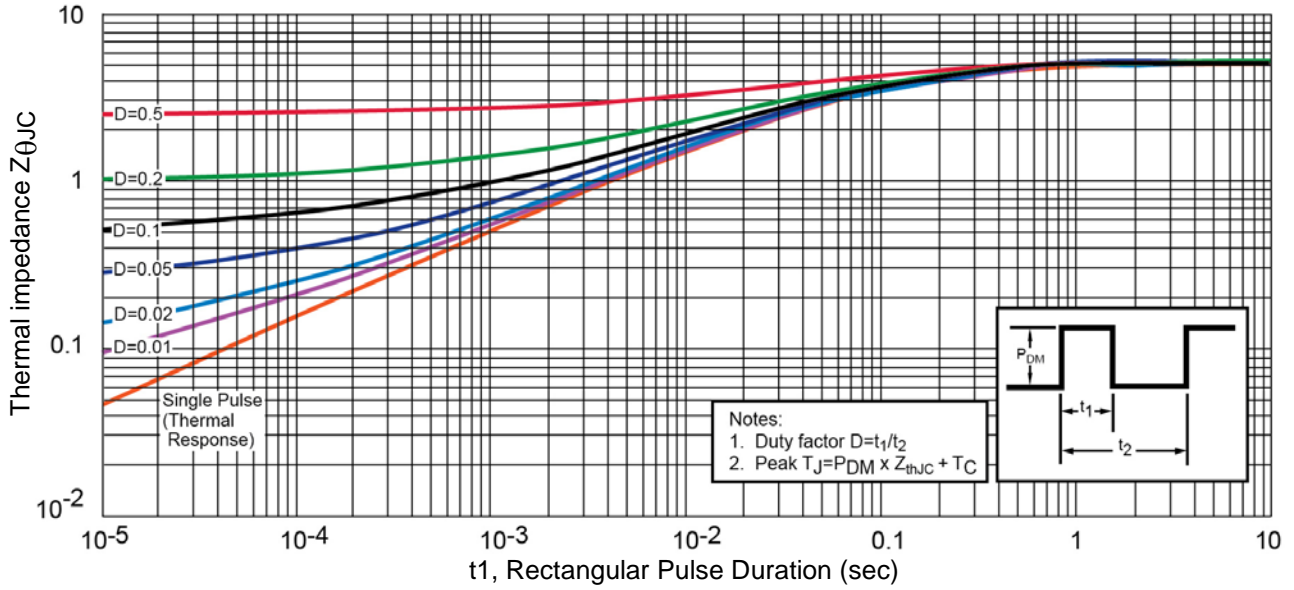
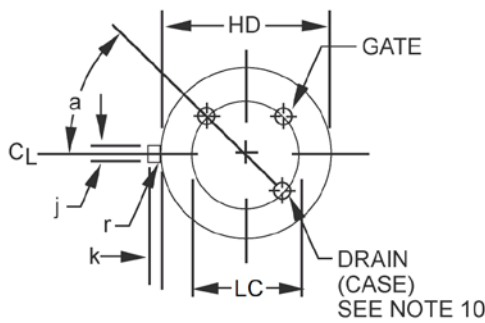
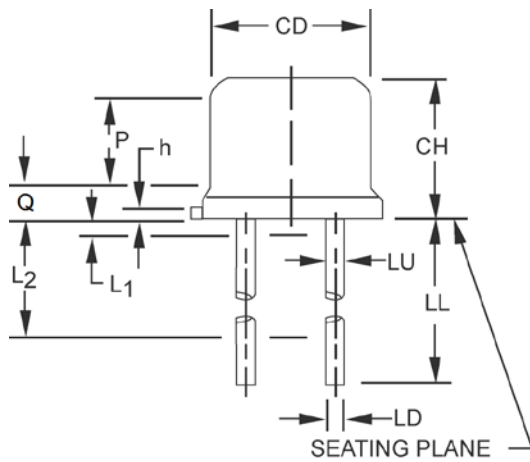

FIGURE 4
Thermal Impedance Curves

PACKAGE DIMENSIONS

Ltr	Dimensions				Notes
	Inch		Millimeters		
	Min	Max	Min	Max	
CD	0.315	0.355	8.00	8.51	
CH	0.160	0.180	4.07	4.57	
HD	0.340	0.370	8.64	9.40	
h	0.009	0.041	0.23	1.04	
j	0.028	0.034	0.71	0.86	3
k	0.029	0.045	0.74	1.14	3, 4
LD	0.016	0.021	0.41	0.53	7, 8
LL	0.500	0.750	12.7	19.05	7, 8, 12
LC	0.200 TP		5.08 TP		6
LU	0.016	0.019	0.41	0.48	7, 8
L1	-	0.050	-	1.27	7, 8
L2	0.250	-	6.35	-	7, 8
P	0.100	-	2.54	-	
Q	-	0.050	-	1.27	5
r	-	0.010	-	0.25	10
α	45° TP		45° TP		6

NOTES:

- Dimensions are in inches.
- Millimeters are given for information only.
- Beyond r (radius) maximum, TL shall be held for a minimum length of 0.011 inch (0.28 mm).
- Dimension TL measured from maximum HD.
- Body contour optional within zone defined by HD, CD, and Q.
- Leads at gauge plane 0.054 +0.001 -0.000 inch (1.37 +0.03 -0.00 mm) below seating plane shall be within 0.007 inch (0.18 mm) radius of true position (TP) at maximum material condition (MMC) relative to tab at MMC.
- Dimension LU applies between L1 and L2. Dimension LD applies between L2 and LL minimum. Diameter is uncontrolled in L1 and beyond LL minimum.
- All three leads.
- The collector shall be internally connected to the case.
- Dimension r (radius) applies to both inside corners of tab.
- In accordance with ASME Y14.5M, diameters are equivalent to Φ x symbology.
- Lead 1 = source, lead 2 = gate, lead 3 = drain.

See schematic on next page

SCHEMATIC

