

**POWER MOS 7® FREDFET**

Power MOS 7® is a new generation of low loss, high voltage, N-Channel enhancement mode power MOSFETS. Both conduction and switching losses are addressed with Power MOS 7® by significantly lowering  $R_{DS(ON)}$  and  $Q_g$ . Power MOS 7® combines lower conduction and switching losses along with exceptionally fast switching speeds inherent with APT's patented metal gate structure.

- Lower Input Capacitance
- Lower Miller Capacitance
- Lower Gate Charge,  $Q_g$
- Increased Power Dissipation
- Easier To Drive
- Popular T-MAX™ or TO-264 Package
- **FAST RECOVERY BODY DIODE**

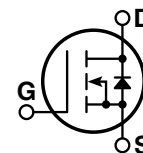
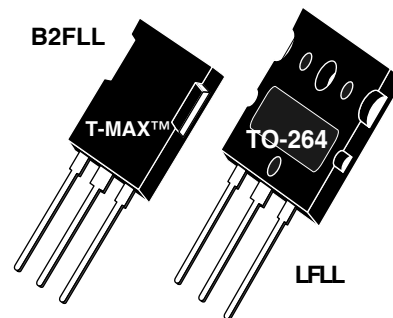

**MAXIMUM RATINGS**

 All Ratings:  $T_C = 25^\circ\text{C}$  unless otherwise specified.

Symbol	Parameter	APT6013B2LL_LLL	UNIT
$V_{DSS}$	Drain-Source Voltage	600	Volts
$I_D$	Continuous Drain Current @ $T_C = 25^\circ\text{C}$	43	Amps
$I_{DM}$	Pulsed Drain Current ①	172	
$V_{GS}$	Gate-Source Voltage Continuous	±30	Volts
$V_{GSM}$	Gate-Source Voltage Transient	±40	
$P_D$	Total Power Dissipation @ $T_C = 25^\circ\text{C}$	565	Watts
	Linear Derating Factor	4.52	W/°C
$T_J, T_{STG}$	Operating and Storage Junction Temperature Range	-55 to 150	°C
$T_L$	Lead Temperature: 0.063" from Case for 10 Sec.	300	
$I_{AR}$	Avalanche Current ① (Repetitive and Non-Repetitive)	43	Amps
$E_{AR}$	Repetitive Avalanche Energy ①	50	mJ
$E_{AS}$	Single Pulse Avalanche Energy ④	2500	

**STATIC ELECTRICAL CHARACTERISTICS**

Symbol	Characteristic / Test Conditions	MIN	TYP	MAX	UNIT
$BV_{DSS}$	Drain-Source Breakdown Voltage ( $V_{GS} = 0V, I_D = 250\mu\text{A}$ )	600			Volts
$R_{DS(on)}$	Drain-Source On-State Resistance ② ( $V_{GS} = 10V, I_D = 21.5A$ )			0.130	Ohms
$I_{DSS}$	Zero Gate Voltage Drain Current ( $V_{DS} = 600V, V_{GS} = 0V$ )			250	$\mu\text{A}$
	Zero Gate Voltage Drain Current ( $V_{DS} = 480V, V_{GS} = 0V, T_C = 125^\circ\text{C}$ )			1000	
$I_{GSS}$	Gate-Source Leakage Current ( $V_{GS} = \pm 30V, V_{DS} = 0V$ )			±100	nA
$V_{GS(th)}$	Gate Threshold Voltage ( $V_{DS} = V_{GS}, I_D = 2.5mA$ )	3		5	Volts

 **CAUTION:** These Devices are Sensitive to Electrostatic Discharge. Proper Handling Procedures Should Be Followed.

APT Website - <http://www.advancedpower.com>

**DYNAMIC CHARACTERISTICS**

**APT6013B2FLL\_LFLL**

Symbol	Characteristic	Test Conditions	MIN	TYP	MAX	UNIT
$C_{iss}$	Input Capacitance	$V_{GS} = 0V$ $V_{DS} = 25V$ $f = 1\text{ MHz}$		5630		pF
$C_{oss}$	Output Capacitance			1060		
$C_{rss}$	Reverse Transfer Capacitance			70		
$Q_g$	Total Gate Charge ③	$V_{GS} = 10V$ $V_{DD} = 300V$ $I_D = 43A @ 25^\circ C$		130		nC
$Q_{gs}$	Gate-Source Charge			25		
$Q_{gd}$	Gate-Drain ("Miller") Charge			40		
$t_{d(on)}$	Turn-on Delay Time	<b>RESISTIVE SWITCHING</b> $V_{GS} = 15V$ $V_{DD} = 300V$ $I_D = 43A @ 25^\circ C$ $R_G = 0.6\Omega$		11		ns
$t_r$	Rise Time			14		
$t_{d(off)}$	Turn-off Delay Time			27		
$t_f$	Fall Time			8		
$E_{on}$	Turn-on Switching Energy ⑥	<b>INDUCTIVE SWITCHING @ 25°C</b> $V_{DD} = 400V, V_{GS} = 15V$ $I_D = 43A, R_G = 5\Omega$		635		$\mu J$
$E_{off}$	Turn-off Switching Energy			585		
$E_{on}$	Turn-on Switching Energy ⑥	<b>INDUCTIVE SWITCHING @ 125°C</b> $V_{DD} = 400V, V_{GS} = 15V$ $I_D = 43A, R_G = 5\Omega$		1030		
$E_{off}$	Turn-off Switching Energy			695		

**SOURCE-DRAIN DIODE RATINGS AND CHARACTERISTICS**

Symbol	Characteristic / Test Conditions	MIN	TYP	MAX	UNIT
$I_S$	Continuous Source Current (Body Diode)			43	Amps
$I_{SM}$	Pulsed Source Current ① (Body Diode)			172	
$V_{SD}$	Diode Forward Voltage ② ( $V_{GS} = 0V, I_S = -43A$ )			1.3	Volts
$dv/dt$	Peak Diode Recovery $dv/dt$ ⑤			15	V/ns
$t_{rr}$	Reverse Recovery Time ( $I_S = -43A, di/dt = 100A/\mu s$ )	$T_j = 25^\circ C$		250	ns
		$T_j = 125^\circ C$		500	
$Q_{rr}$	Reverse Recovery Charge ( $I_S = -43A, di/dt = 100A/\mu s$ )	$T_j = 25^\circ C$		2.27	$\mu C$
		$T_j = 125^\circ C$		6.87	
$I_{RRM}$	Peak Recovery Current ( $I_S = -43A, di/dt = 100A/\mu s$ )	$T_j = 25^\circ C$		14.2	Amps
		$T_j = 125^\circ C$		27	

**THERMAL CHARACTERISTICS**

Symbol	Characteristic	MIN	TYP	MAX	UNIT
$R_{\theta JC}$	Junction to Case			0.22	$^\circ C/W$
$R_{\theta JA}$	Junction to Ambient			40	

① Repetitive Rating: Pulse width limited by maximum junction temperature

② Pulse Test: Pulse width < 380  $\mu s$ , Duty Cycle < 2%

③ See MIL-STD-750 Method 3471

④ Starting  $T_j = +25^\circ C$ ,  $L = 2.70mH$ ,  $R_G = 25\Omega$ , Peak  $I_L = 43A$

⑤  $dv/dt$  numbers reflect the limitations of the test circuit rather than the device itself.  $I_S \leq -I_D 43A$   $di/dt \leq 700A/\mu s$   $V_R \leq V_{DSS}$   $T_j \leq 150^\circ C$

⑥  $E_{on}$  includes diode reverse recovery. See figures 18, 20.

APT Reserves the right to change, without notice, the specifications and information contained herein.

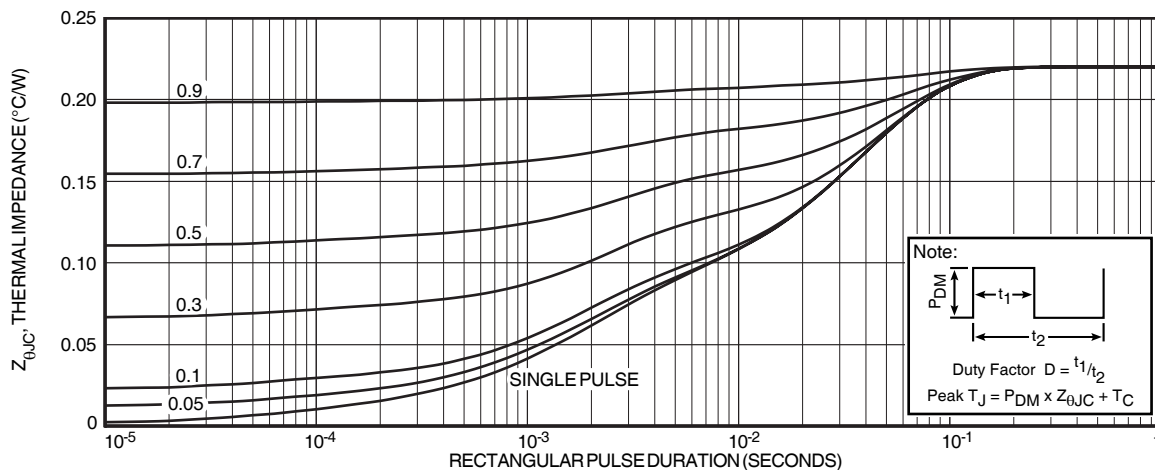

FIGURE 1, MAXIMUM EFFECTIVE TRANSIENT THERMAL IMPEDANCE, JUNCTION-TO-CASE vs PULSE DURATION

# Typical Performance Curves

APT6013B2FLL\_LFLL

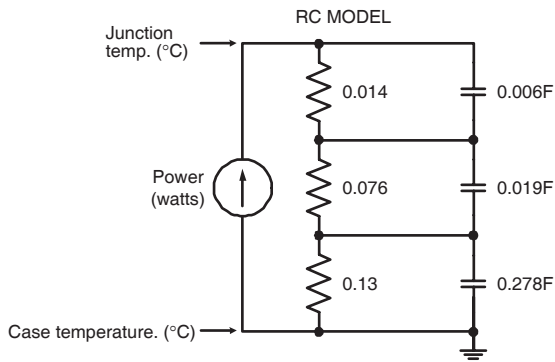

FIGURE 2, TRANSIENT THERMAL IMPEDANCE MODEL

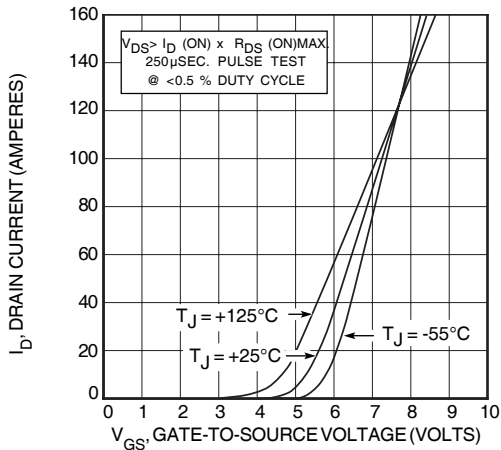

FIGURE 4, TRANSFER CHARACTERISTICS

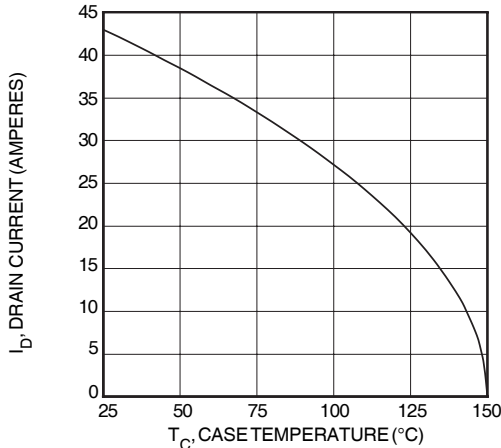

FIGURE 6, MAXIMUM DRAIN CURRENT vs CASE TEMPERATURE

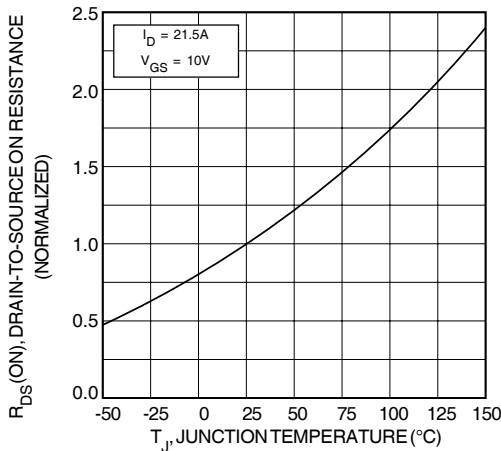

FIGURE 8, ON-RESISTANCE vs. TEMPERATURE

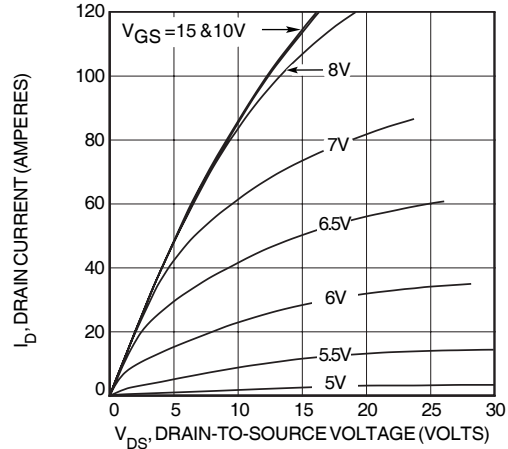

FIGURE 3, LOW VOLTAGE OUTPUT CHARACTERISTICS

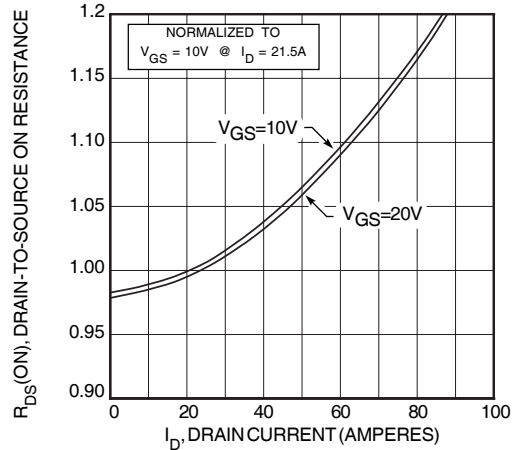

FIGURE 5,  $R_{DS(ON)}$  vs DRAIN CURRENT

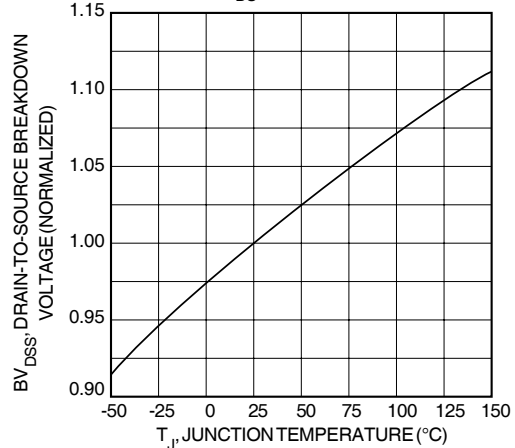

FIGURE 7, BREAKDOWN VOLTAGE vs TEMPERATURE

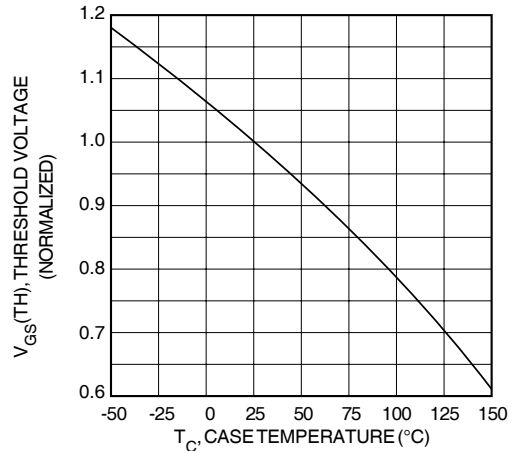

FIGURE 9, THRESHOLD VOLTAGE vs TEMPERATURE

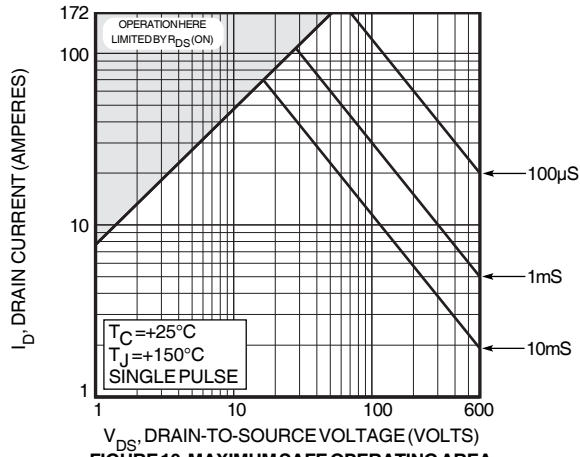

FIGURE 10, MAXIMUM SAFE OPERATING AREA

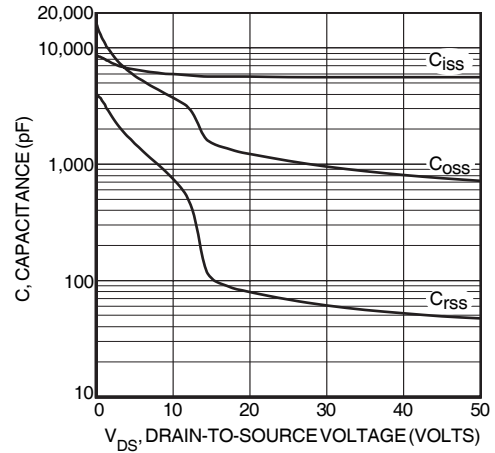

FIGURE 11, CAPACITANCE vs DRAIN-TO-SOURCE VOLTAGE

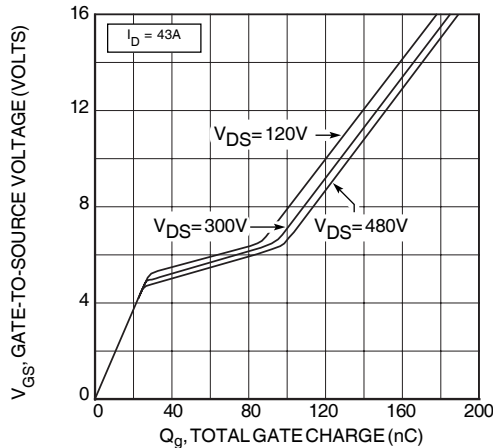

FIGURE 12, GATE CHARGES vs GATE-TO-SOURCE VOLTAGE

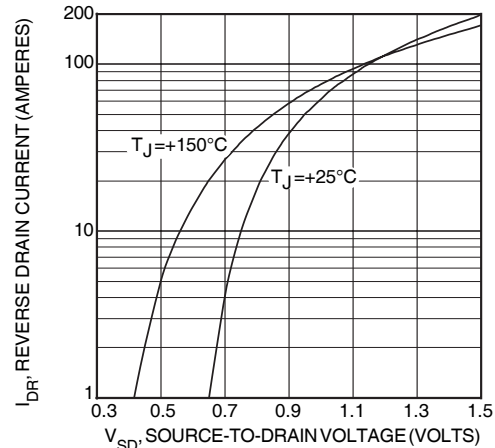

FIGURE 13, SOURCE-DRAIN DIODE FORWARD VOLTAGE

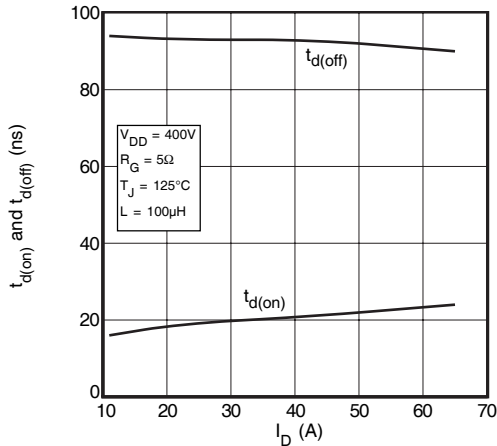

FIGURE 14, DELAY TIMES vs CURRENT

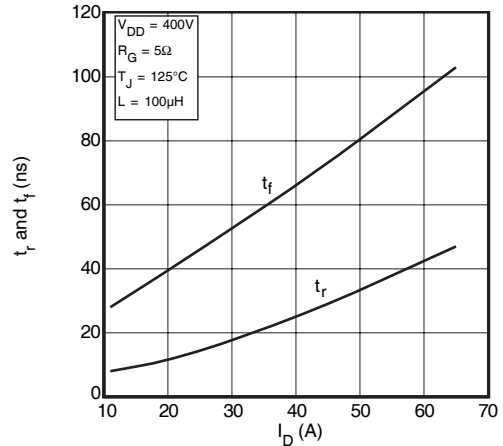

FIGURE 15, RISE AND FALL TIMES vs CURRENT

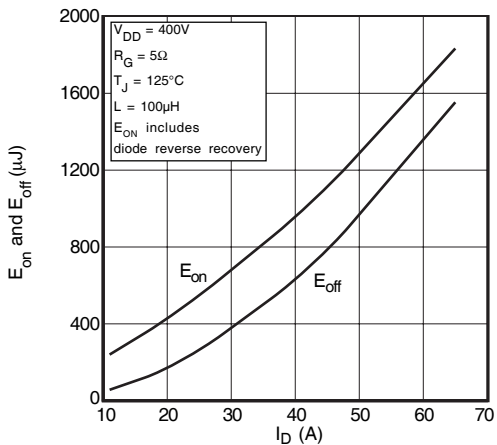

FIGURE 16, SWITCHING ENERGY vs CURRENT

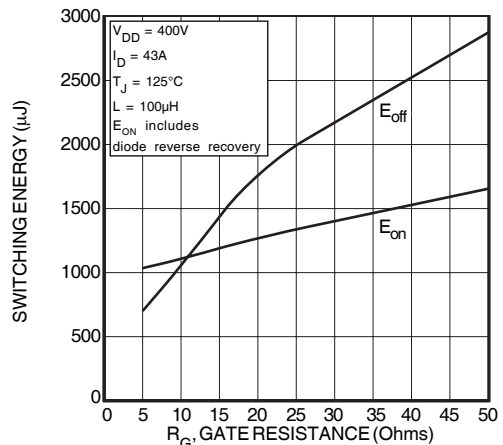
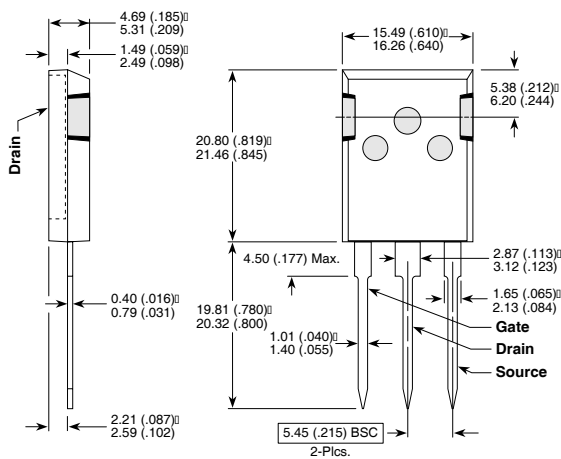

FIGURE 17, SWITCHING ENERGY vs. GATE RESISTANCE

**T-MAX™ (B2) Package Outline**



These dimensions are equal to the TO-247 without the mounting hole.

Dimensions in Millimeters and (Inches)

**TO-264 (L) Package Outline**

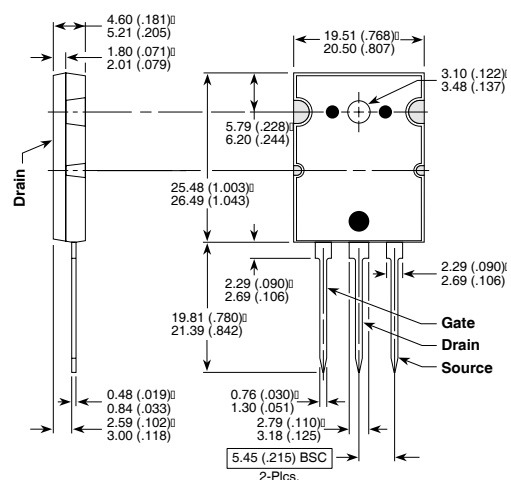

Dimensions in Millimeters and (Inches)

APT's products are covered by one or more of U.S. patents 4,895,810 5,045,903 5,089,434 5,182,234 5,019,522

5,262,336 6,503,786 5,256,583 4,748,103 5,283,202 5,231,474 5,434,095 5,528,058 and foreign patents. US and Foreign patents pending. All Rights Reserved.