

Super Junction MOSFET

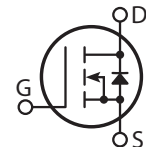
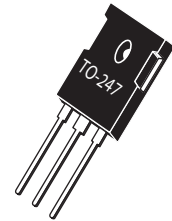

- Ultra Low $R_{DS(ON)}$
- Low Miller Capacitance
- Ultra Low Gate Charge, Q_g
- Avalanche Energy Rated
- Extreme dv/dt Rated
- Dual die (parallel)
- Popular T-MAX Package

Unless stated otherwise, Microsemi discrete MOSFETs contain a single MOSFET die. This device is made with two parallel MOSFET die. It is intended for switch-mode operation. It is not suitable for linear mode operation.

MAXIMUM RATINGS

All Ratings per die: $T_C = 25^\circ\text{C}$ unless otherwise specified.

Symbol	Parameter	APT36N90BC3G	UNIT
V_{DSS}	Drain-Source Voltage	900	Volts
I_D	Continuous Drain Current @ $T_C = 25^\circ\text{C}$	36	Amps
	Continuous Drain Current @ $T_C = 100^\circ\text{C}$	23	
I_{DM}	Pulsed Drain Current ¹	96	
V_{GS}	Gate-Source Voltage Continuous	± 20	Volts
P_D	Total Power Dissipation @ $T_C = 25^\circ\text{C}$	390	Watts
T_J, T_{STG}	Operating and Storage Junction Temperature Range	-55 to 150	$^\circ\text{C}$
T_L	Lead Temperature: 0.063" from Case for 10 Sec.	260	
dv/dt	Drain-Source Voltage slope ($V_{DS} = 400\text{V}$, $I_D = 36\text{A}$, $T_J = 125^\circ\text{C}$)	50	V/ns
I_{AR}	Avalanche Current ²	8.8	Amps
E_{AR}	Repetitive Avalanche Energy ² ($I_d = 8.8\text{A}$, $V_{dd} = 50\text{V}$)	2.9	mJ
E_{AS}	Single Pulse Avalanche Energy ($I_d = 8.8\text{A}$, $V_{dd} = 50\text{V}$)	1940	

STATIC ELECTRICAL CHARACTERISTICS

Symbol	Characteristic / Test Conditions	MIN	TYP	MAX	UNIT
$BV_{(DSS)}$	Drain-Source Breakdown Voltage ($V_{GS} = 0\text{V}$, $I_D = 250\mu\text{A}$)	900			Volts
$R_{DS(on)}$	Drain-Source On-State Resistance ³ ($V_{GS} = 10\text{V}$, $I_D = 18\text{A}$)		0.10	0.12	Ohms
I_{DSS}	Zero Gate Voltage Drain Current ($V_{DS} = 900\text{V}$, $V_{GS} = 0\text{V}$)	-	-	100	μA
	Zero Gate Voltage Drain Current ($V_{DS} = 900\text{V}$, $V_{GS} = 0\text{V}$, $T_C = 150^\circ\text{C}$)	-	50	-	
I_{GSS}	Gate-Source Leakage Current ($V_{GS} = \pm 20\text{V}$, $V_{DS} = 0\text{V}$)	-	-	100	nA
$V_{GS(th)}$	Gate Threshold Voltage ($V_{DS} = V_{GS}$, $I_D = 2.9\text{mA}$)	2.5	3	3.5	Volts

 CAUTION: These Devices are Sensitive to Electrostatic Discharge. Proper Handling Procedures Should Be Followed.

"COOLMOS™" comprise a new family of transistors developed by Infineon Technologies AG. "COOLMOS" is a trademark of Infineon Technologies AG.

Microsemi Website - <http://www.microsemi.com>

Symbol	Characteristic	Test Conditions	MIN	TYP	MAX	UNIT
C_{iss}	Input Capacitance	$V_{GS} = 0V$ $V_{DS} = 25V$ $f = 1\text{ MHz}$		7463		pF
C_{oss}	Output Capacitance			6827		
C_{rss}	Reverse Transfer Capacitance			167		
Q_g	Total Gate Charge ⁴	$V_{GS} = 10V$ $V_{DD} = 450V$ $I_D = 36A @ 25^\circ C$		252		nC
Q_{gs}	Gate-Source Charge			38		
Q_{gd}	Gate-Drain ("Miller") Charge			112		
$t_{d(on)}$	Turn-on Delay Time	INDUCTIVE SWITCHING $V_{GS} = 15V$ $V_{DD} = 600V$ $I_D = 36A @ 25^\circ C$ $R_G = 4.3\Omega$		70		ns
t_r	Rise Time			20		
$t_{d(off)}$	Turn-off Delay Time			400		
t_f	Fall Time			25		
E_{on}	Turn-on Switching Energy ⁵	INDUCTIVE SWITCHING @ 25°C $V_{DD} = 600V, V_{GS} = 15V$ $I_D = 36A, R_G = 4.3\Omega$		1500		μJ
E_{off}	Turn-off Switching Energy			750		
E_{on}	Turn-on Switching Energy ⁵	INDUCTIVE SWITCHING @ 125°C $V_{DD} = 600V, V_{GS} = 15V$ $I_D = 36A, R_G = 4.3\Omega$		2130		μJ
E_{off}	Turn-off Switching Energy			867		

SOURCE-DRAIN DIODE RATINGS AND CHARACTERISTICS

Symbol	Characteristic / Test Conditions	MIN	TYP	MAX	UNIT
I_S	Continuous Source Current (Body Diode)		36		Amps
I_{SM}	Pulsed Source Current ¹ (Body Diode)		96		Amps
V_{SD}	Diode Forward Voltage ³ ($V_{GS} = 0V, I_S = 18A$)		0.8	1.2	Volts
dv/dt	Peak Diode Recovery dv/dt ⁶			10	V/ns
t_{rr}	Reverse Recovery Time ($I_S = -36A, di/dt = 100A/\mu s$)	$T_j = 25^\circ C$		930	ns
		$T_j = 125^\circ C$		1230	
Q_{rr}	Reverse Recovery Charge ($I_S = -36A, di/dt = 100A/\mu s$)	$T_j = 25^\circ C$		35	μC
		$T_j = 125^\circ C$		44	
I_{RRM}	Peak Recovery Current ($I_S = -36A, di/dt = 100A/\mu s$)	$T_j = 25^\circ C$		70	Amps
		$T_j = 125^\circ C$		68	

THERMAL CHARACTERISTICS

Symbol	Characteristic	MIN	TYP	MAX	UNIT
$R_{\theta JC}$	Junction to Case			0.3	°C/W
$R_{\theta JA}$	Junction to Ambient			31	

- 1 Repetitive Rating: Pulse width limited by maximum junction temperature
- 2 Repetitive avalanche causes additional power losses that can be calculated as $P_{AV} = E_{AR} * f$. Pulse width tp limited by Tj max.
- 3 Pulse Test: Pulse width < 380 μs, Duty Cycle < 2%
- 4 See MIL-STD-750 Method 3471
- 5 Eon includes diode reverse recovery.
- 6 Maximum 125°C diode commutation speed = di/dt 600A/μs

Microsemi reserves the right to change, without notice, the specifications and information contained herein.

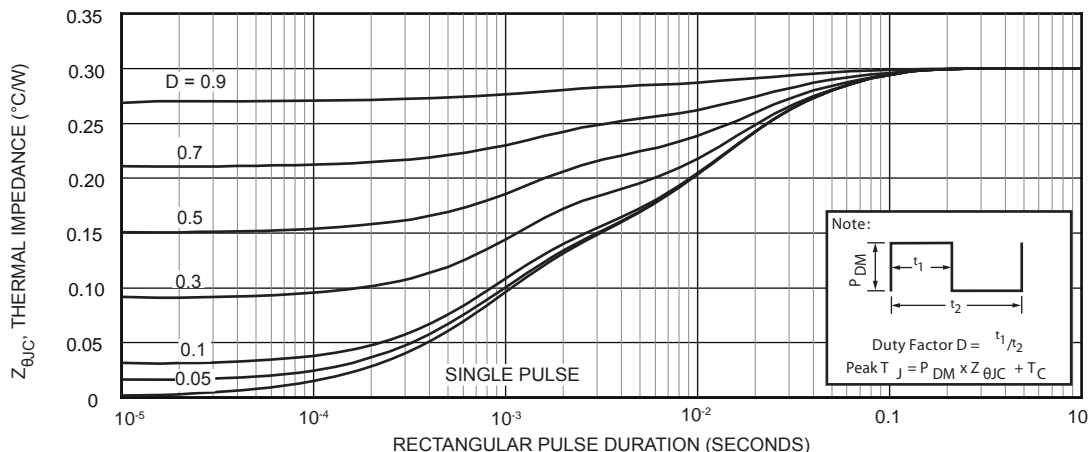

Figure 1, Maximum Effective Transient Thermal Impedance, Junction-To-Case vs Pulse Duration

Typical Performance Curves

APT36N90BC3G

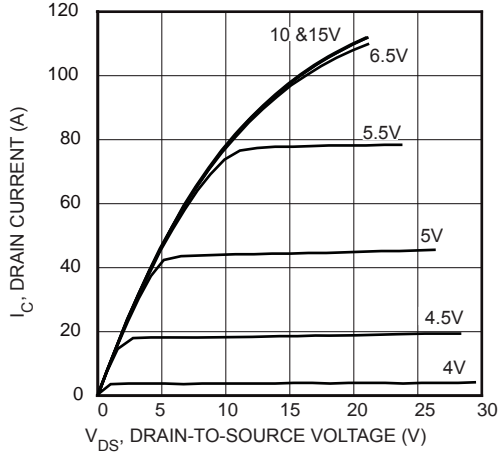

FIGURE 2, Low Voltage Output Characteristics

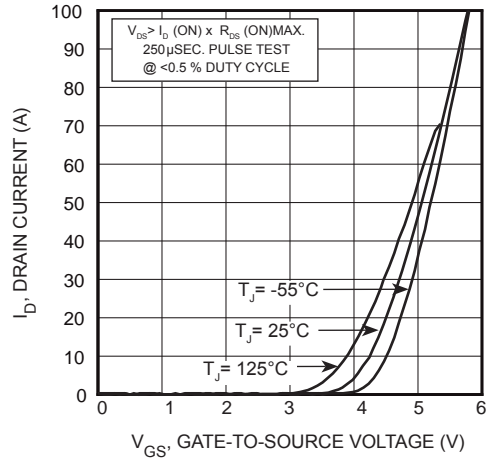

FIGURE 3, Transfer Characteristics

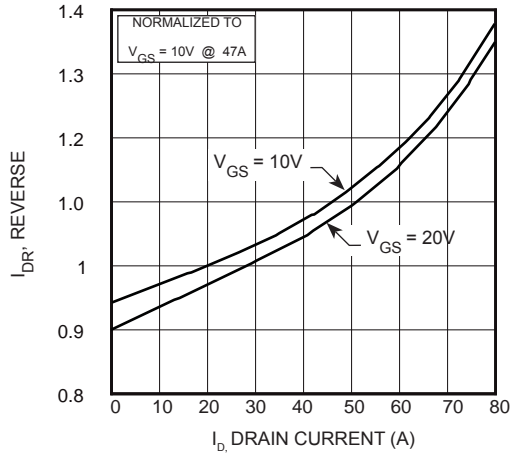

FIGURE 4, $R_{DS(ON)}$ vs Drain Current

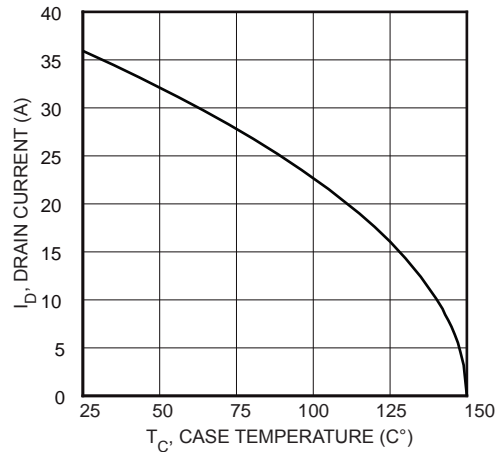

FIGURE 5, Maximum Drain Current vs Case Temperature

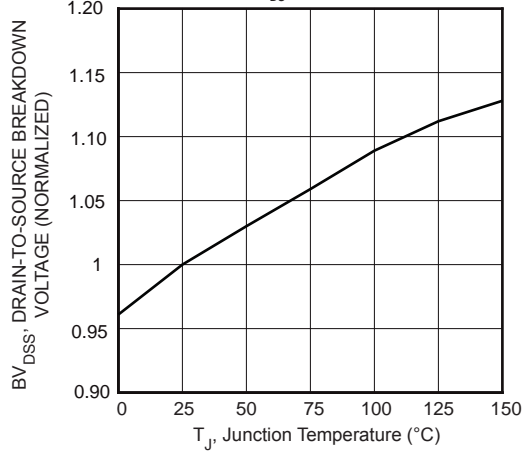

FIGURE 6, Breakdown Voltage vs Temperature

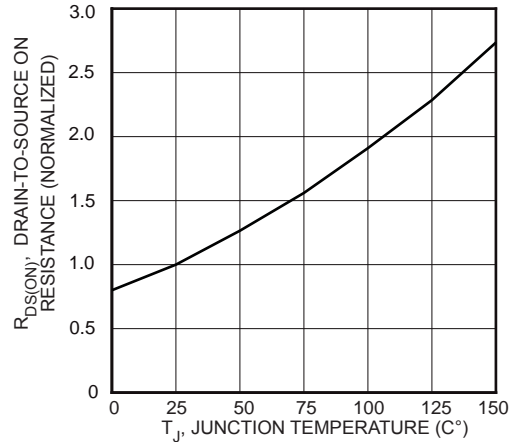

FIGURE 7, On-Resistance vs Temperature

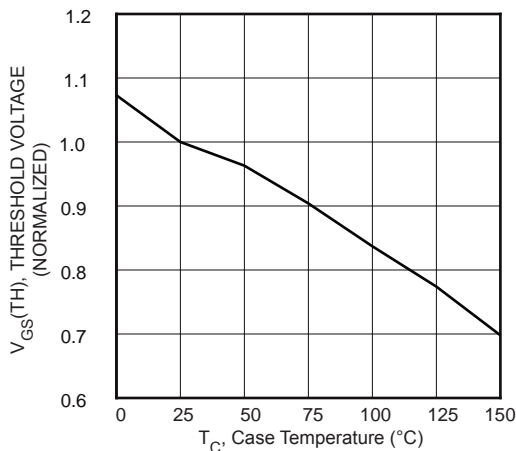

FIGURE 8, Threshold Voltage vs Temperature

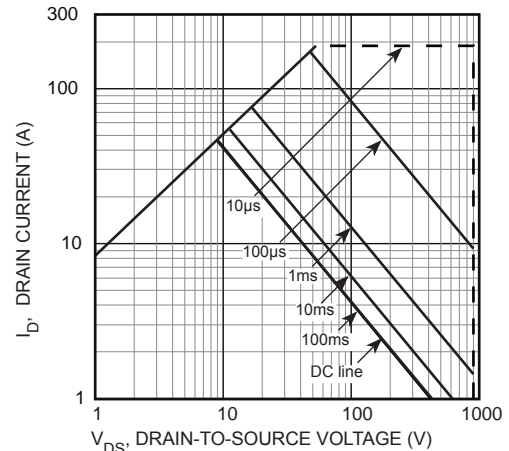

FIGURE 9, Maximum Safe Operating Area

Typical Performance Curves

APT36N90BC3G

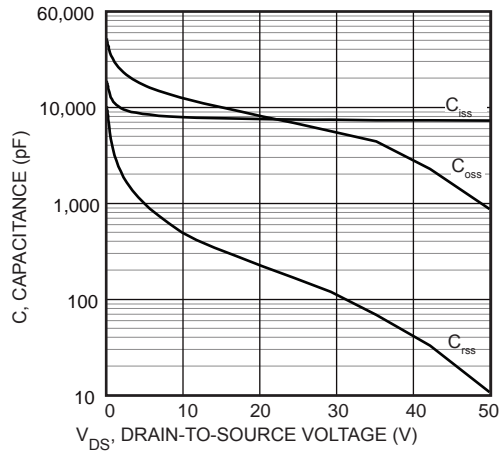

FIGURE 10, Capacitance vs Drain-To-Source Voltage

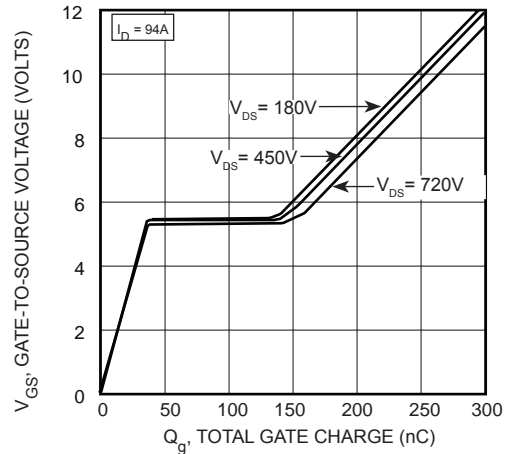

FIGURE 11, Gate Charges vs Gate-To-Source Voltage

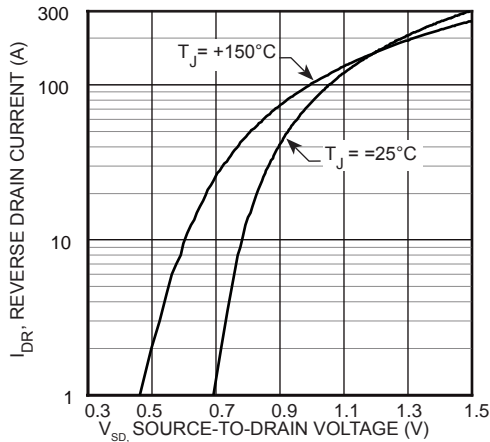

FIGURE 12, Source-Drain Diode Forward Voltage

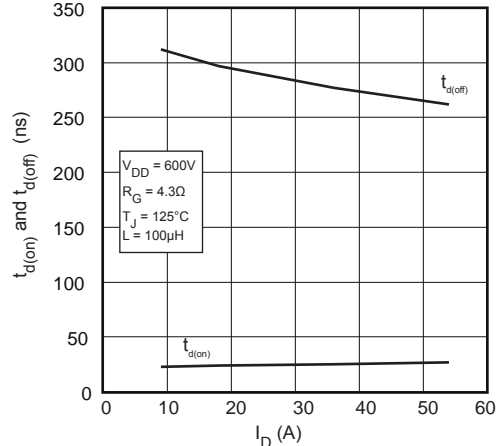

FIGURE 13, Delay Times vs Current

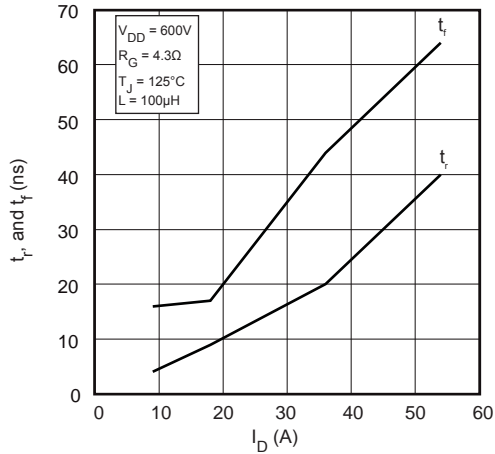

FIGURE 14, Rise and Fall Times vs Current

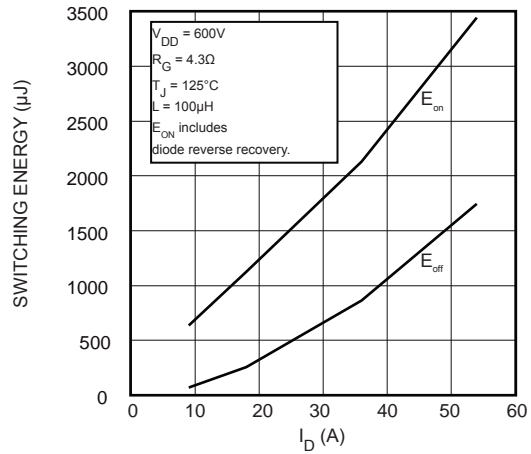

FIGURE 15, Switching Energy vs Current

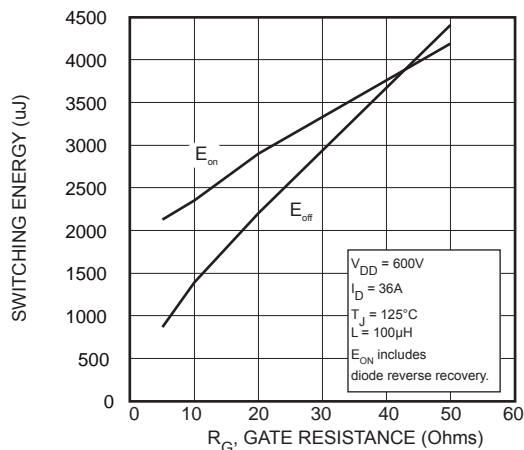

FIGURE 16, Switching Energy vs Gate Resistance

Typical Performance Curves

APT36N90BC3G

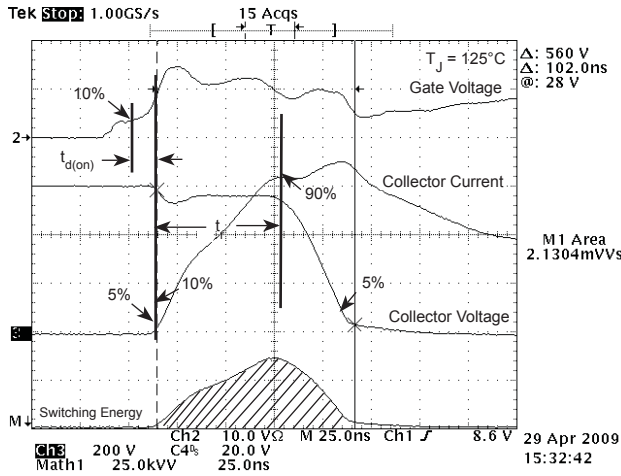

Figure 17, Turn-on Switching Waveforms and Definitions

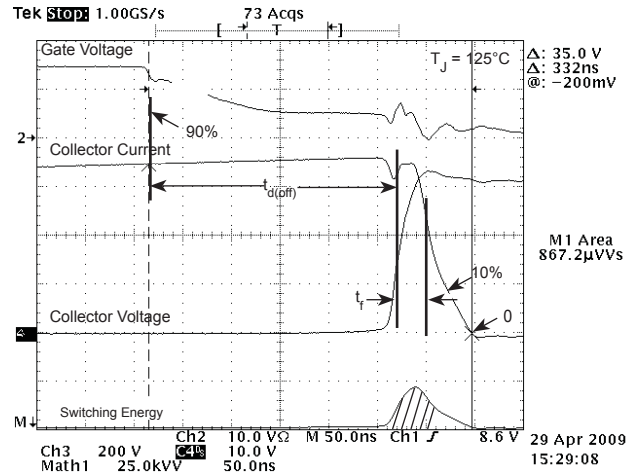

Figure 18, Turn-off Switching Waveforms and Definitions

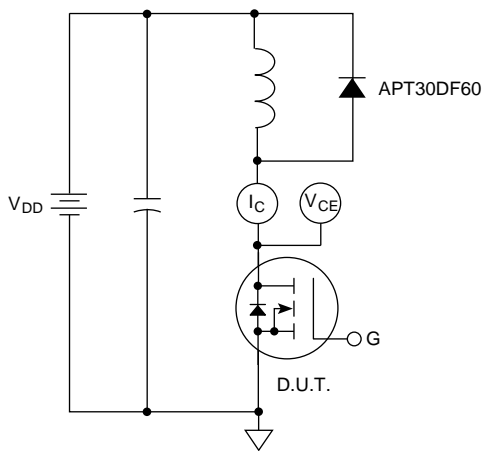

Figure 19, Inductive Switching Test Circuit

TO-247[®] Package Outline

