

## High Speed PT IGBT

APT68GA60LD40

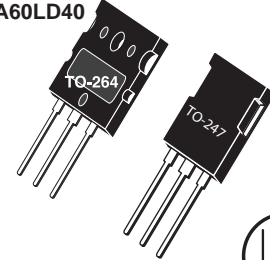

APT68GA60B2D40

Combi (IGBT and Diode)

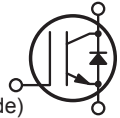

POWER MOS 8® is a high speed Punch-Through switch-mode IGBT. Low  $E_{off}$  is achieved through leading technology silicon design and lifetime control processes. A reduced  $E_{off} - V_{CE(ON)}$  tradeoff results in superior efficiency compared to other IGBT technologies. Low gate charge and a greatly reduced ratio of  $C_{res}/C_{ies}$  provide excellent noise immunity, short delay times and simple gate drive. The intrinsic chip gate resistance and capacitance of the poly-silicone gate structure help control di/dt during switching, resulting in low EMI, even when switching at high frequency.

### FEATURES

- Fast switching with low EMI
- Very Low  $E_{off}$  for maximum efficiency
- Ultra low  $C_{res}$  for improved noise immunity
- Low conduction loss
- Low gate charge
- Increased intrinsic gate resistance for low EMI
- RoHS compliant 

### TYPICAL APPLICATIONS

- ZVS phase shifted and other full bridge
- Half bridge
- High power PFC boost
- Welding
- UPS, solar, and other inverters
- High frequency, high efficiency industrial

### Absolute Maximum Ratings

Symbol	Parameter	Ratings	Unit
$V_{CES}$	Collector Emitter Voltage	600	V
$I_{C1}$	Continuous Collector Current @ $T_c = 25^\circ\text{C}$	121	A
$I_{C2}$	Continuous Collector Current @ $T_c = 100^\circ\text{C}$	68	
$I_{CM}$	Pulsed Collector Current <sup>1</sup>	202	
$V_{GE}$	Gate-Emitter Voltage <sup>2</sup>	$\pm 30$	V
$P_D$	Total Power Dissipation @ $T_c = 25^\circ\text{C}$	520	W
SSOA	Switching Safe Operating Area @ $T_j = 150^\circ\text{C}$	202A @ 600V	
$T_J, T_{STG}$	Operating and Storage Junction Temperature Range	-55 to 150	°C
$T_L$	Lead Temperature for Soldering: 0.063" from Case for 10 Seconds	300	

### Static Characteristics

 $T_J = 25^\circ\text{C}$  unless otherwise specified

Symbol	Parameter	Test Conditions	Min	Typ	Max	Unit
$V_{BR(CES)}$	Collector-Emitter Breakdown Voltage	$V_{GE} = 0V, I_C = 250\mu\text{A}$	600			V
$V_{CE(on)}$	Collector-Emitter On Voltage	$V_{GE} = 15V, I_C = 40A$ $T_J = 25^\circ\text{C}$ $T_J = 125^\circ\text{C}$		2.0 1.9	2.5	
$V_{GE(th)}$	Gate Emitter Threshold Voltage	$V_{GE} = V_{CE}, I_C = 1mA$	3	4.5	6	
$I_{CES}$	Zero Gate Voltage Collector Current	$V_{CE} = 600V, V_{GE} = 0V$ $T_J = 25^\circ\text{C}$ $T_J = 125^\circ\text{C}$			275 3000	$\mu\text{A}$
$I_{GES}$	Gate-Emitter Leakage Current	$V_{GS} = \pm 30V$			$\pm 100$	nA

**Dynamic Characteristics**
 **$T_J = 25^\circ\text{C}$  unless otherwise specified**
**APT68GA60L\_B2D40**

Symbol	Parameter	Test Conditions	Min	Typ	Max	Unit	
$C_{ies}$	Input Capacitance	Capacitance $V_{GE} = 0V, V_{CE} = 25V$ $f = 1\text{MHz}$		5230		pF	
$C_{oes}$	Output Capacitance			526			
$C_{res}$	Reverse Transfer Capacitance			59			
$Q_g^3$	Total Gate Charge	Gate Charge $V_{GE} = 15V$ $V_{CE} = 300V$ $I_C = 40A$		198		nC	
$Q_{ge}$	Gate-Emitter Charge			32			
$Q_{gc}$	Gate-Collector Charge			66			
SSOA	Switching Safe Operating Area	$T_J = 150^\circ\text{C}, R_G = 4.7\Omega^4, V_{GE} = 15V,$ $L = 100\mu\text{H}, V_{CE} = 600V$	202			A	
$t_{d(on)}$	Turn-On Delay Time	Inductive Switching ( $25^\circ\text{C}$ ) $V_{CC} = 400V$ $V_{GE} = 15V$ $I_C = 40A$ $R_G = 4.7\Omega^4$ $T_J = +25^\circ\text{C}$		21		ns	
$t_r$	Current Rise Time			27			
$t_{d(off)}$	Turn-Off Delay Time			133			
$t_f$	Current Fall Time			88			
$E_{on2}$	Turn-On Switching Energy			715			$\mu\text{J}$
$E_{off}^6$	Turn-Off Switching Energy		607				
$t_{d(on)}$	Turn-On Delay Time	Inductive Switching ( $125^\circ\text{C}$ ) $V_{CC} = 400V$ $V_{GE} = 15V$ $I_C = 40A$ $R_G = 4.7\Omega^4$ $T_J = +125^\circ\text{C}$		20		ns	
$t_r$	Current Rise Time			26			
$t_{d(off)}$	Turn-Off Delay Time			175			
$t_f$	Current Fall Time			129			
$E_{on2}$	Turn-On Switching Energy			1117			$\mu\text{J}$
$E_{off}^6$	Turn-Off Switching Energy			1025			

**Thermal and Mechanical Characteristics**

Symbol	Characteristic	Min	Typ	Max	Unit
$R_{\theta JC}$	Junction to Case Thermal Resistance (IGBT)	-	-	.24	$^\circ\text{C/W}$
$R_{\theta JC}$	Junction to Case Thermal Resistance (Diode)			.67	
$W_T$	Package Weight	-	6.1	-	g
Torque	Mounting Torque (TO-264 Package), 4-40 or M3 screw			10	in-lbf

1 Repetitive Rating: Pulse width and case temperature limited by maximum junction temperature.

2 Pulse test: Pulse Width  $< 380\mu\text{s}$ , duty cycle  $< 2\%$ .

3 See Mil-Std-750 Method 3471.

4  $R_G$  is external gate resistance, not including internal gate resistance or gate driver impedance. (MIC4452)

5  $E_{on2}$  is the clamped inductive turn on energy that includes a commutating diode reverse recovery current in the IGBT turn on energy loss. A combi device is used for the clamping diode.

6  $E_{off}$  is the clamped inductive turn-off energy measured in accordance with JEDEC standard JESD24-1.

**Microsemi reserves the right to change, without notice, the specifications and information contained herein.**

Typical Performance Curves

APT68GA60L\_B2D40

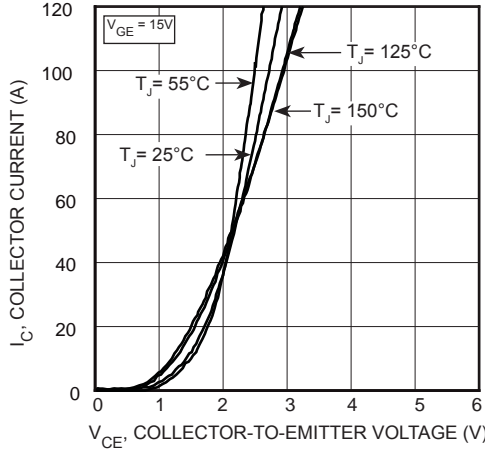

FIGURE 1, Output Characteristics ( $T_J = 25^\circ\text{C}$ )

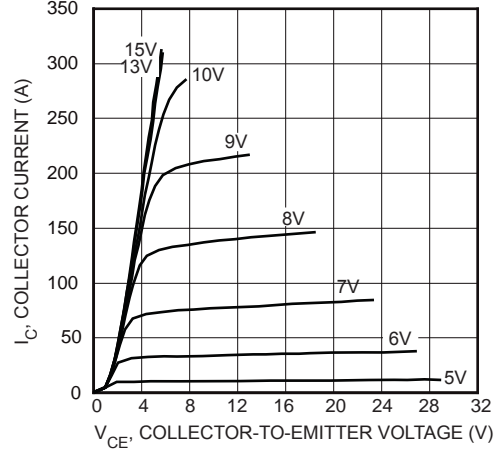

FIGURE 2, Output Characteristics ( $T_J = 25^\circ\text{C}$ )

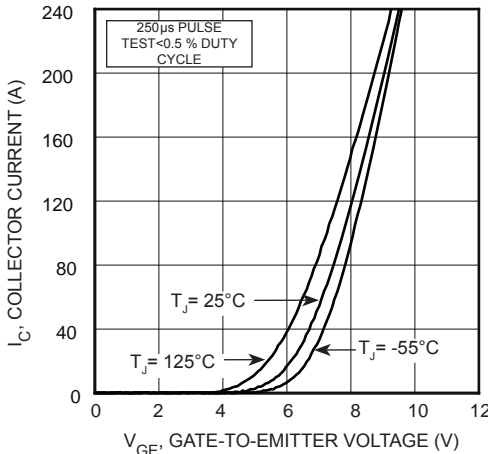

FIGURE 3, Transfer Characteristics

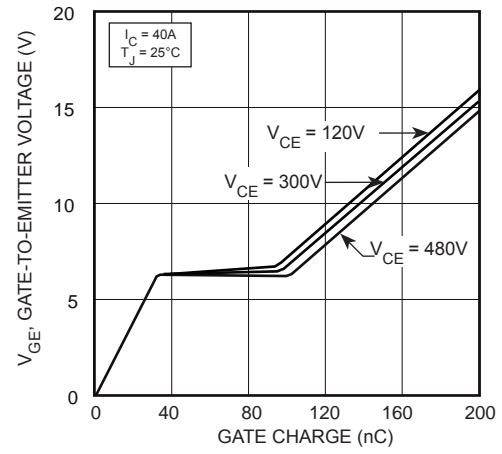

FIGURE 4, Gate charge

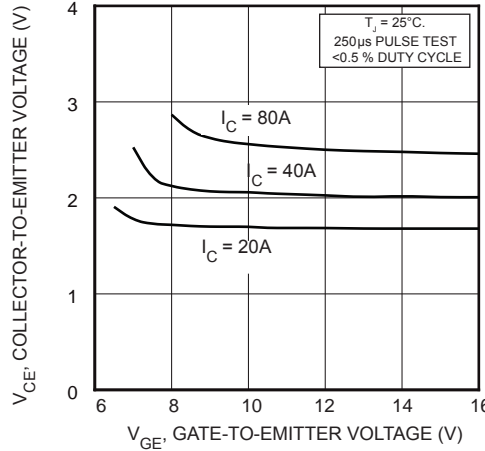

FIGURE 5, On State Voltage vs Gate-to-Emitter Voltage

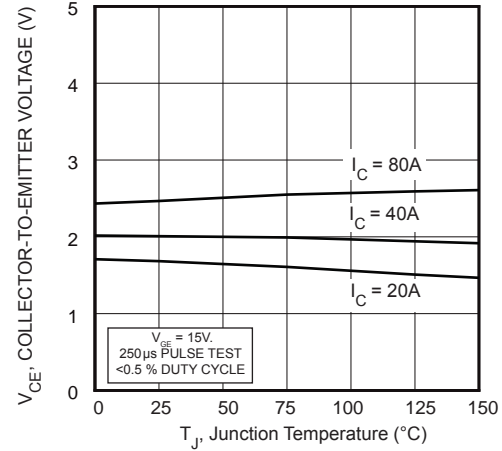

FIGURE 6, On State Voltage vs Junction Temperature

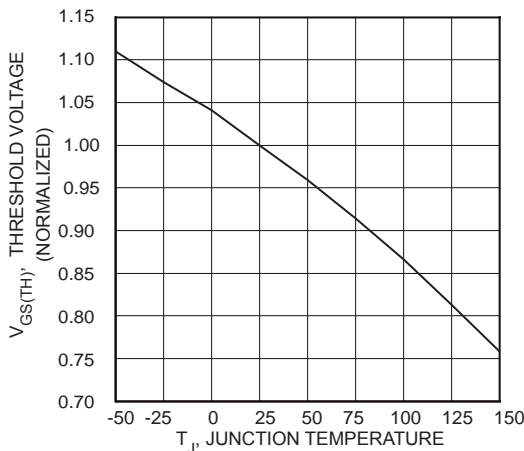

FIGURE 7, Threshold Voltage vs Junction Temperature

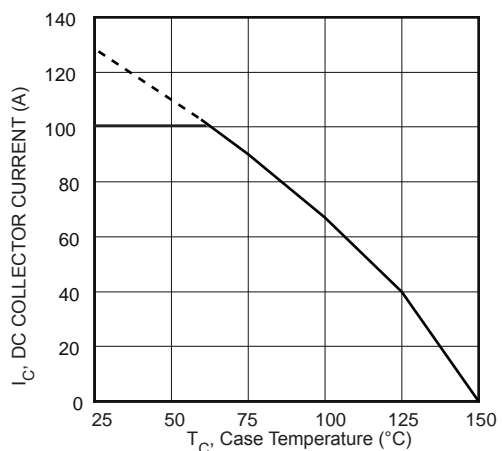

FIGURE 8, DC Collector Current vs Case Temperature

# Typical Performance Curves

APT68GA60L\_B2D40

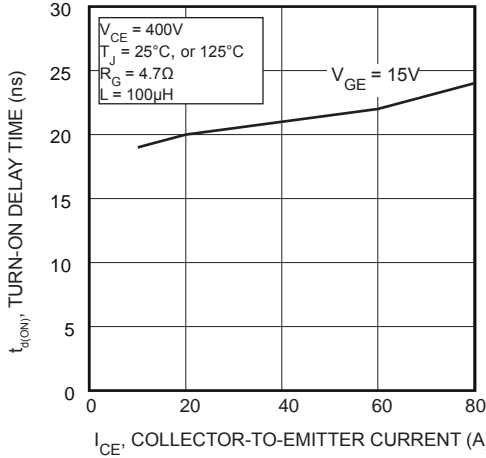

FIGURE 9, Turn-On Delay Time vs Collector Current

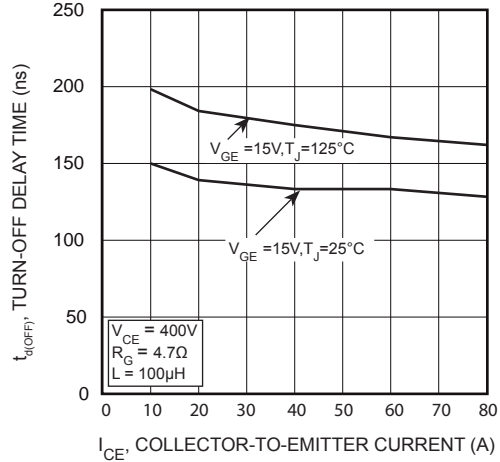

FIGURE 10, Turn-Off Delay Time vs Collector Current

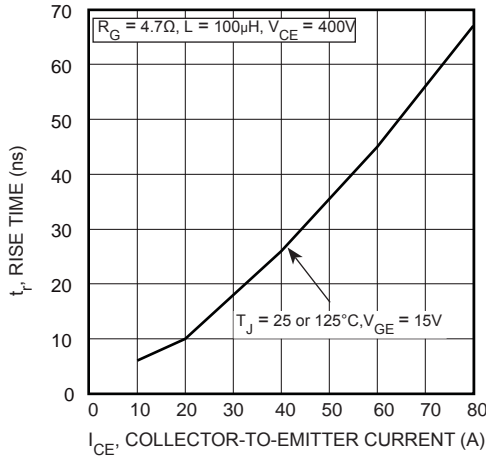

FIGURE 11, Current Rise Time vs Collector Current

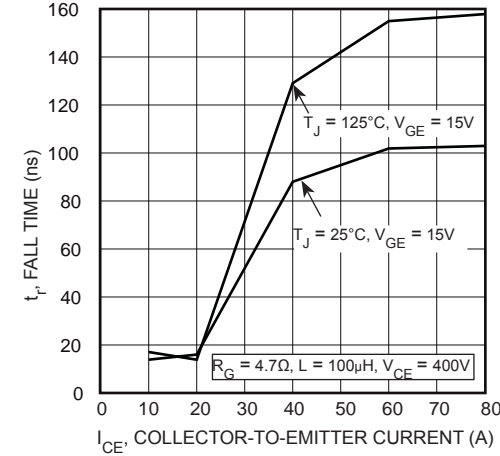

FIGURE 12, Current Fall Time vs Collector Current

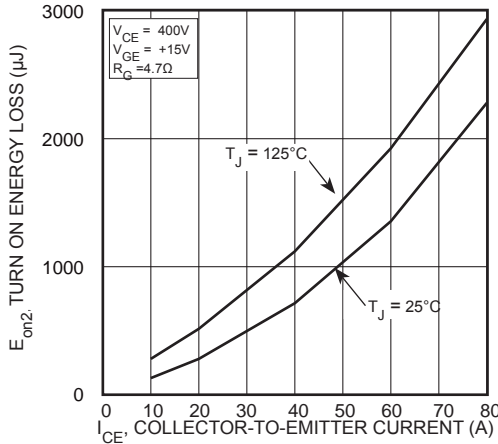

FIGURE 13, Turn-On Energy Loss vs Collector Current

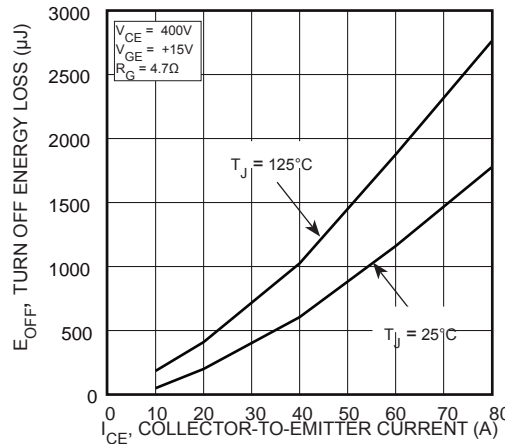

FIGURE 14, Turn-Off Energy Loss vs Collector Current

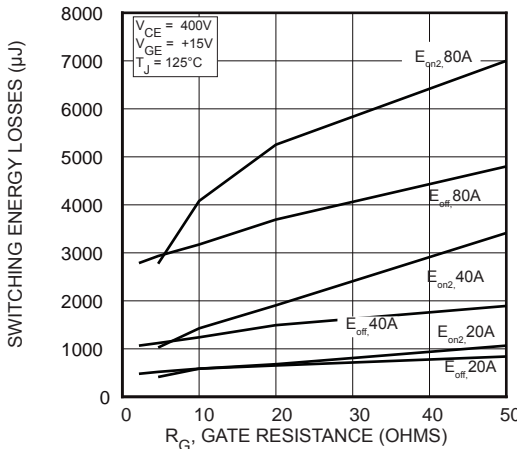

FIGURE 15, Switching Energy Losses vs Gate Resistance

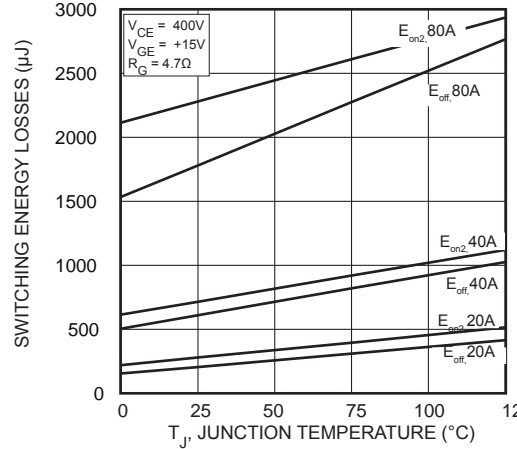

FIGURE 16, Switching Energy Losses vs Junction Temperature

# Typical Performance Curves

APT68GA60L\_B2D40

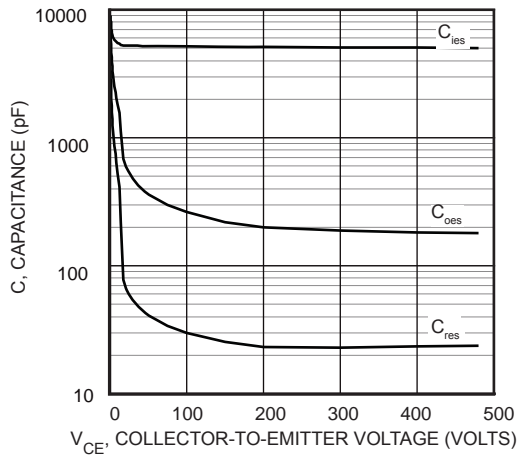

FIGURE 17, Capacitance vs Collector-To-Emitter Voltage

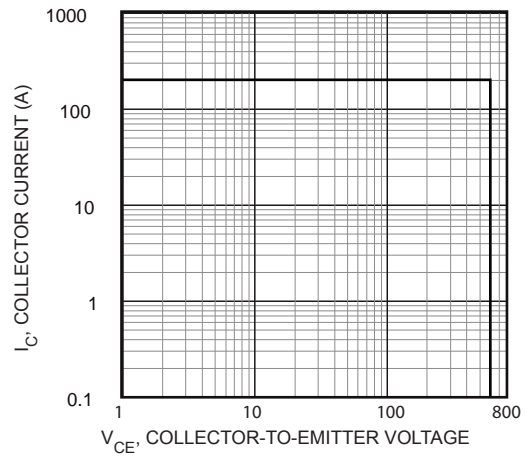

FIGURE 18, Minimum Switching Safe Operating Area

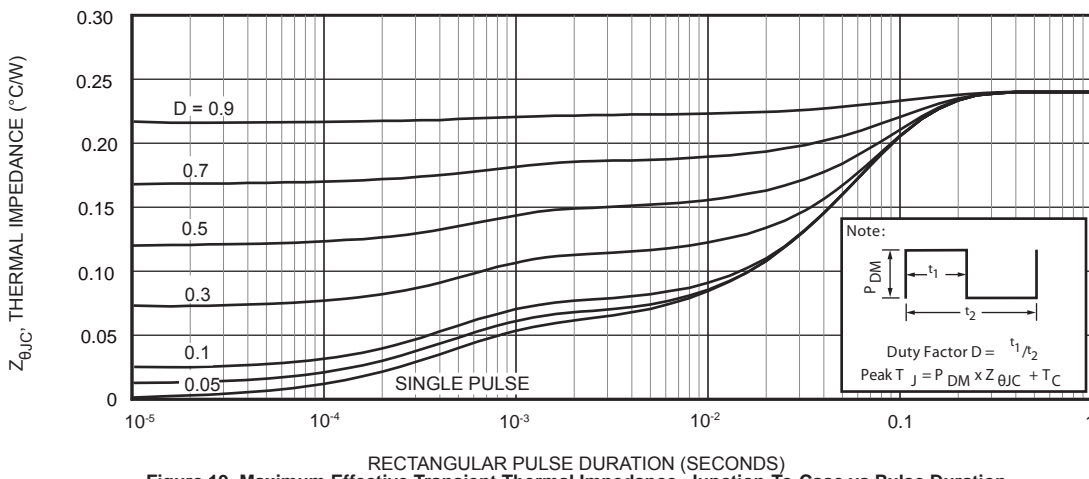

Figure 19, Maximum Effective Transient Thermal Impedance, Junction-To-Case vs Pulse Duration

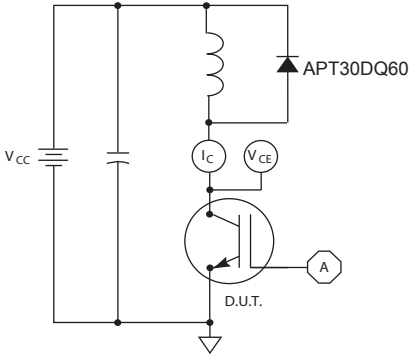

Figure 20, Inductive Switching Test Circuit

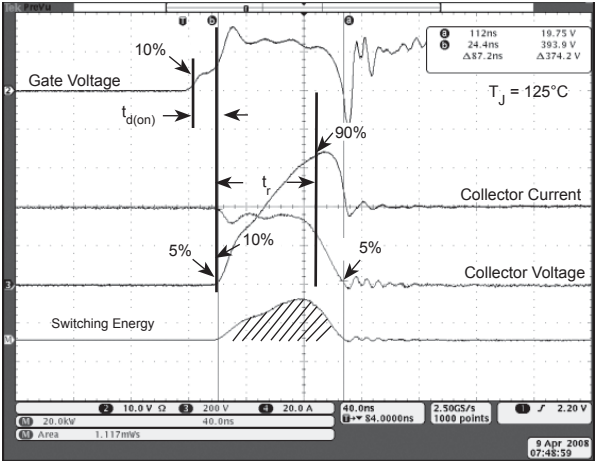

Figure 21, Turn-on Switching Waveforms and Definitions

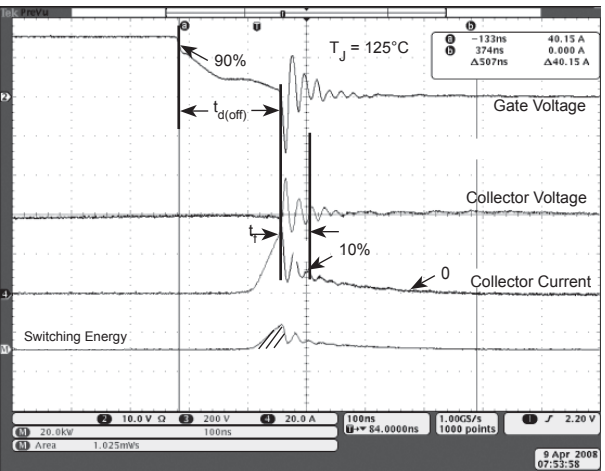

Figure 22, Turn-off Switching Waveforms and Definitions

# ULTRAFAST SOFT RECOVERY RECTIFIER DIODE

## MAXIMUM RATINGS

All Ratings:  $T_C = 25^\circ\text{C}$  unless otherwise specified.

Symbol	Characteristic / Test Conditions	APT68GA60L_B2D40	Unit
$I_{F(AV)}$	Maximum Average Forward Current ( $T_C = 111^\circ\text{C}$ , Duty Cycle = 0.5)	40	Amps
$I_{F(RMS)}$	RMS Forward Current (Square wave, 50% duty)	63	
$I_{FSM}$	Non-Repetitive Forward Surge Current ( $T_J = 45^\circ\text{C}$ , 8.3 ms)	320	

## STATIC ELECTRICAL CHARACTERISTICS

Symbol	Characteristic / Test Conditions	Min	Type	Max	Unit
$V_F$	Forward Voltage		$I_F = 40\text{A}$	2.0	Volts
			$I_F = 80\text{A}$	2.5	
			$I_F = 40\text{A}, T_J = 125^\circ\text{C}$	1.7	

## DYNAMIC CHARACTERISTICS

Symbol	Characteristic	Test Conditions	Min	Typ	Max	Unit
$t_{rr}$	Reverse Recovery Time	$I_F = 1\text{A}, di_F/dt = -100\text{A}/\mu\text{s}, V_R = 30\text{V}, T_J = 25^\circ\text{C}$	-	22	-	ns
$t_{rr}$	Reverse Recovery Time	$I_F = 40\text{A}, di_F/dt = -200\text{A}/\mu\text{s}, V_R = 400\text{V}, T_C = 25^\circ\text{C}$	-	25	-	nAmps
$Q_{rr}$	Reverse Recovery Charge		-	35	-	
$I_{RRM}$	Maximum Reverse Recovery Current		-	3	-	
$t_{rr}$	Reverse Recovery Time	$I_F = 40\text{A}, di_F/dt = -200\text{A}/\mu\text{s}, V_R = 400\text{V}, T_C = 125^\circ\text{C}$	-	160	-	ns
$Q_{rr}$	Reverse Recovery Charge		-	480	-	nC
$I_{RRM}$	Maximum Reverse Recovery Current		-	6	-	Amps
$t_{rr}$	Reverse Recovery Time	$I_F = 40\text{A}, di_F/dt = -1000\text{A}/\mu\text{s}, V_R = 400\text{V}, T_C = 125^\circ\text{C}$	-	85	-	ns
$Q_{rr}$	Reverse Recovery Charge		-	920	-	nC
$I_{RRM}$	Maximum Reverse Recovery Current		-	20	-	Amps

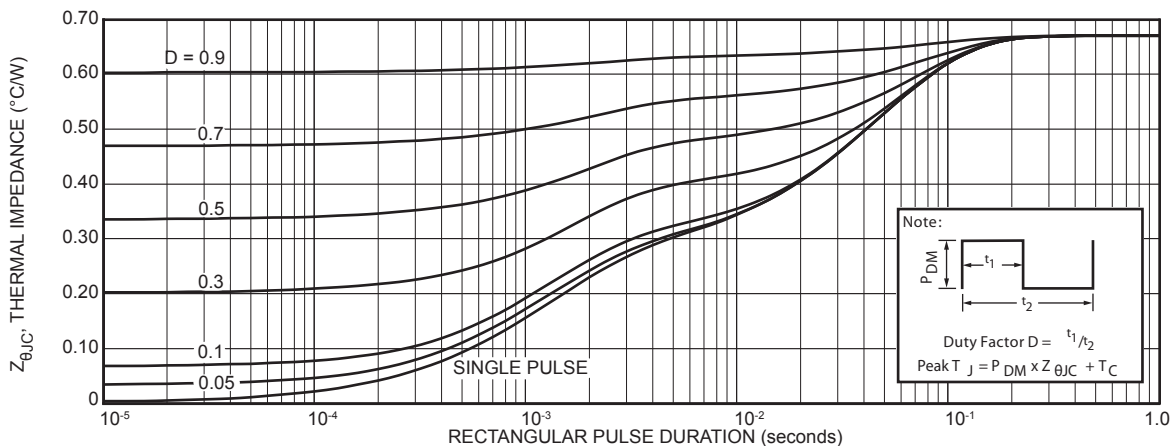

FIGURE 23. MAXIMUM EFFECTIVE TRANSIENT THERMAL IMPEDANCE, JUNCTION-TO-CASE vs. PULSE DURATION

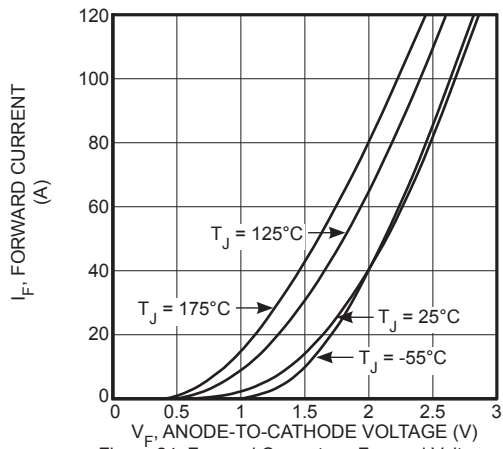

Figure 24. Forward Current vs. Forward Voltage

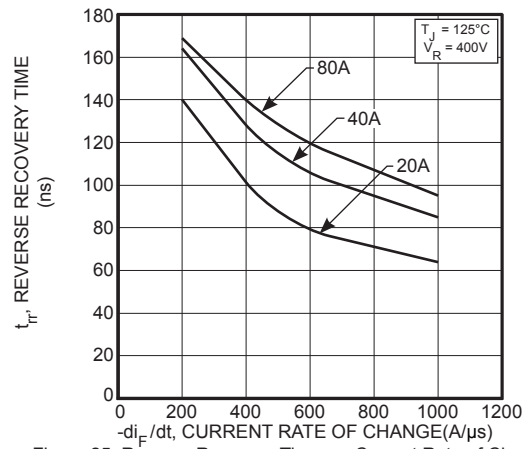

Figure 25. Reverse Recovery Time vs. Current Rate of Change

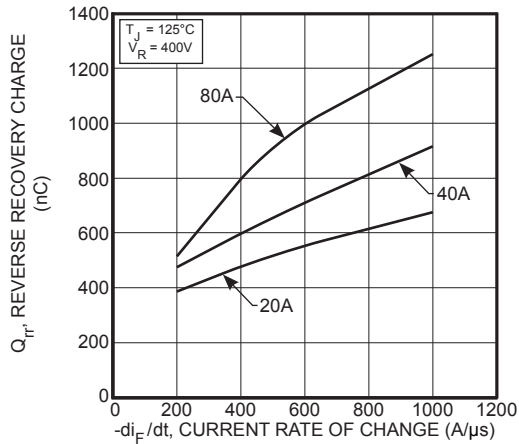

Figure 26. Reverse Recovery Charge vs. Current Rate of Change

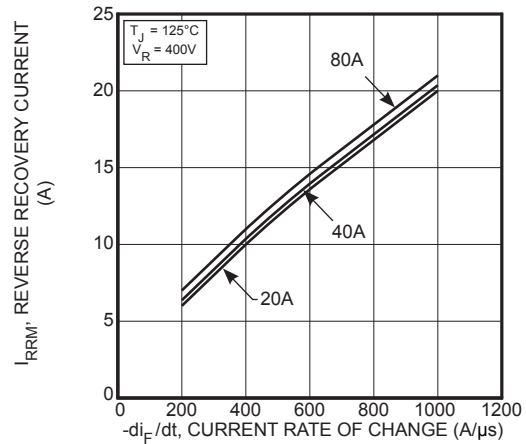

Figure 27. Reverse Recovery Current vs. Current Rate of Change

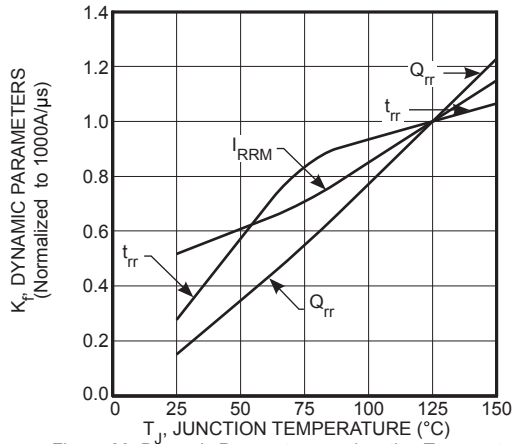

Figure 28. Dynamic Parameters vs. Junction Temperature

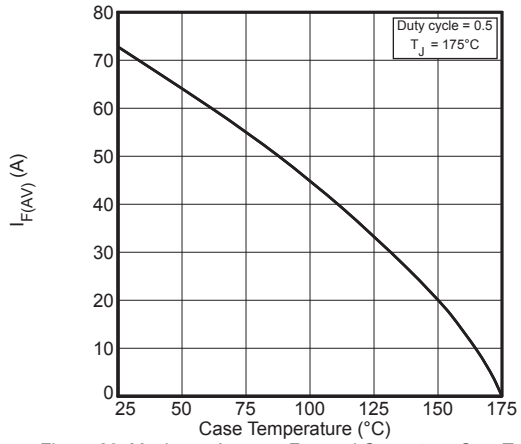

Figure 29. Maximum Average Forward Current vs. Case Temperature

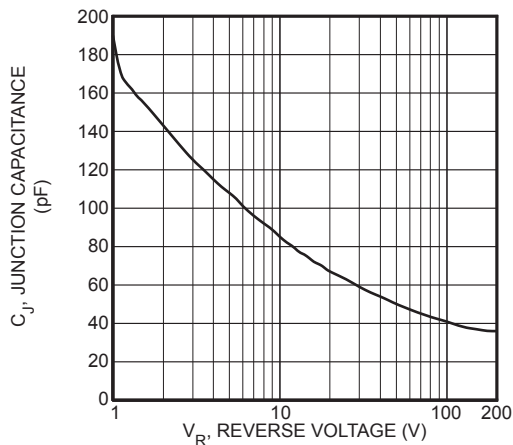

Figure 30. Junction Capacitance vs. Reverse Voltage



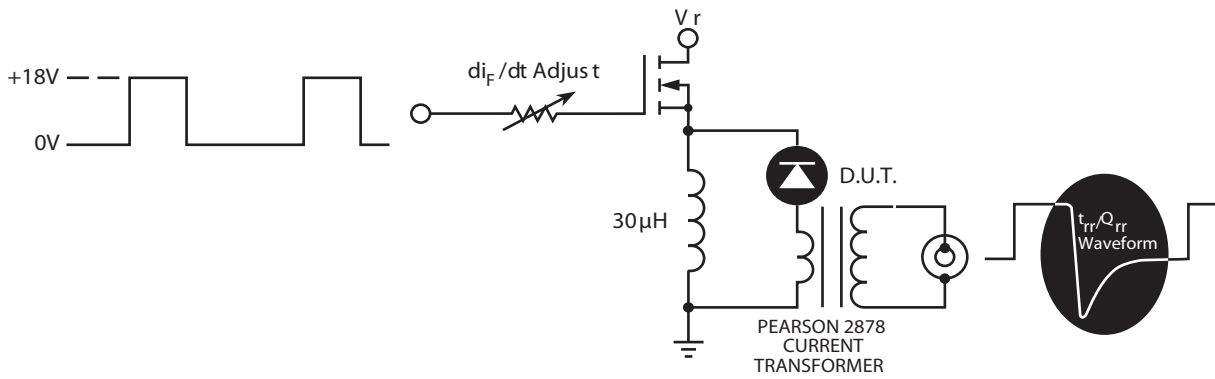

Figure 31. Diode Test Circuit

- 1  $I_F$  - Forward Conduction Current
- 2  $di_F/dt$  - Rate of Diode Current Change Through Zero Crossing.
- 3  $I_{RRM}$  - Maximum Reverse Recovery Current
- 4  $t_{rr}$  - Reverse Recovery Time measured from zero crossing where diode current goes from positive to negative, to the point at which the straight line through  $I_{RRM}$  and  $0.25 I_{RRM}$  passes through zero.
- 5  $Q_{rr}$  - Area Under the Curve Defined by  $I_{RRM}$  and  $t_{rr}$ .

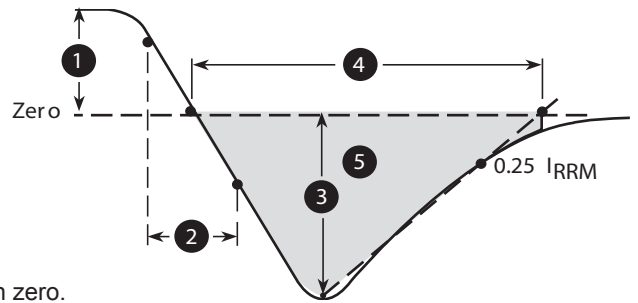
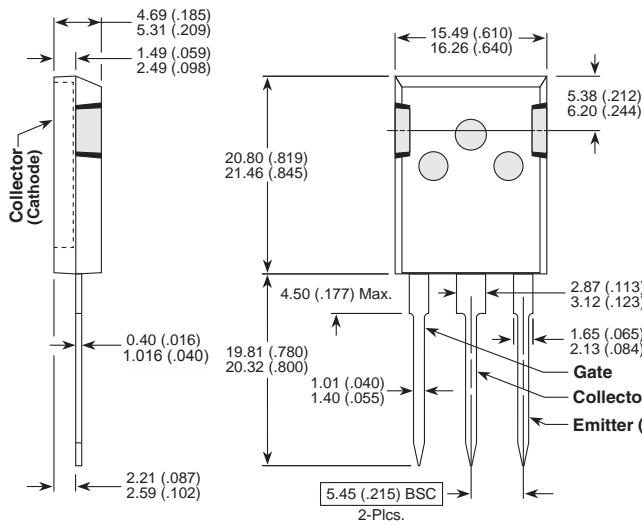

Figure 32. Diode Reverse Recovery Waveform Definition

T-MAX™ (B2) Package Outline



These dimensions are equal to the TO-247 without the mounting hole.  
Dimensions in Millimeters and (Inches)

TO-264 (L) Package Outline

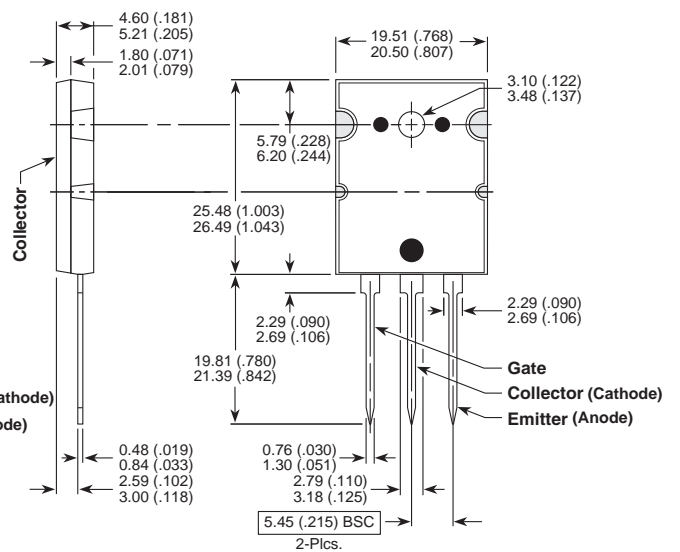

Dimensions in Millimeters and (Inches)