

POWER MOS V®

FREDFET

Power MOS V® is a new generation of high voltage N-Channel enhancement mode power MOSFETs. This new technology minimizes the JFET effect, increases packing density and reduces the on-resistance. Power MOS V® also achieves faster switching speeds through optimized gate layout.

- Fast Recovery Body Diode
- Lower Leakage
- Faster Switching
- 100% Avalanche Tested
- New T-MAX™ Package
(Clip-mounted TO-247 Package)

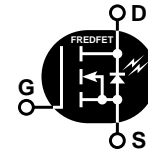
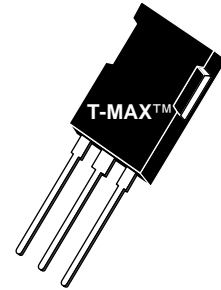

MAXIMUM RATINGS

 All Ratings: $T_C = 25^\circ\text{C}$ unless otherwise specified.

Symbol	Parameter	APT8030B2VFR	UNIT
V_{DSS}	Drain-Source Voltage	800	Volts
I_D	Continuous Drain Current @ $T_C = 25^\circ\text{C}$	27	Amps
I_{DM}	Pulsed Drain Current ^①	108	
V_{GS}	Gate-Source Voltage Continuous	± 30	Volts
V_{GSM}	Gate-Source Voltage Transient	± 40	
P_D	Total Power Dissipation @ $T_C = 25^\circ\text{C}$	520	Watts
	Linear Derating Factor	4.16	W/°C
T_J, T_{STG}	Operating and Storage Junction Temperature Range	-55 to 150	°C
T_L	Lead Temperature: 0.063" from Case for 10 Sec.	300	
I_{AR}	Avalanche Current ^① (Repetitive and Non-Repetitive)	27	Amps
E_{AR}	Repetitive Avalanche Energy ^①	50	mJ
E_{AS}	Single Pulse Avalanche Energy ^④	2500	

STATIC ELECTRICAL CHARACTERISTICS

Symbol	Characteristic / Test Conditions	MIN	TYP	MAX	UNIT
BV_{DSS}	Drain-Source Breakdown Voltage ($V_{GS} = 0V, I_D = 250\mu\text{A}$)	800			Volts
$I_{D(on)}$	On State Drain Current ^② ($V_{DS} > I_{D(on)} \times R_{DS(on)}$ Max, $V_{GS} = 10V$)	27			Amps
$R_{DS(on)}$	Drain-Source On-State Resistance ^② ($V_{GS} = 10V, 0.5 I_{D[Cont.]}$)			0.300	Ohms
I_{DSS}	Zero Gate Voltage Drain Current ($V_{DS} = V_{DSS}, V_{GS} = 0V$)			250	μA
	Zero Gate Voltage Drain Current ($V_{DS} = 0.8 V_{DSS}, V_{GS} = 0V, T_C = 125^\circ\text{C}$)			1000	
I_{GSS}	Gate-Source Leakage Current ($V_{GS} = \pm 30V, V_{DS} = 0V$)			± 100	nA
$V_{GS(th)}$	Gate Threshold Voltage ($V_{DS} = V_{GS}, I_D = 2.5\text{mA}$)	2		4	Volts

 **CAUTION:** These Devices are Sensitive to Electrostatic Discharge. Proper Handling Procedures Should Be Followed.

USA

405 S.W. Columbia Street

EUROPE

Avenue J.F. Kennedy Bât B4 Parc Cadéra Nord

APT Website - <http://www.advancedpower.com>

Bend, Oregon 97702-1035

Phone: (541) 382-8028

FAX: (541) 388-0364

F-33700 Merignac - France

Phone: (33) 5 57 92 15 15

FAX: (33) 5 56 47 97 61

DYNAMIC CHARACTERISTICS

APT8030B2VFR

Symbol	Characteristic	Test Conditions	MIN	TYP	MAX	UNIT
C_{iss}	Input Capacitance	$V_{GS} = 0V$		6600	7900	pF
C_{oss}	Output Capacitance	$V_{DS} = 25V$		645	900	
C_{rss}	Reverse Transfer Capacitance	$f = 1\text{ MHz}$		320	480	
Q_g	Total Gate Charge ^③	$V_{GS} = 10V$		340	510	nC
Q_{gs}	Gate-Source Charge	$V_{DD} = 0.5 V_{DSS}$		31	47	
Q_{gd}	Gate-Drain ("Miller") Charge	$I_D = I_D [\text{Cont.}] @ 25^\circ\text{C}$		170	250	
$t_{d(on)}$	Turn-on Delay Time	$V_{GS} = 15V$		16	32	ns
t_r	Rise Time	$V_{DD} = 0.5 V_{DSS}$		14	28	
$t_{d(off)}$	Turn-off Delay Time	$I_D = I_D [\text{Cont.}] @ 25^\circ\text{C}$		59	90	
t_f	Fall Time	$R_G = 0.6\Omega$		8	16	

SOURCE-DRAIN DIODE RATINGS AND CHARACTERISTICS

Symbol	Characteristic / Test Conditions	MIN	TYP	MAX	UNIT
I_S	Continuous Source Current (Body Diode)			27	Amps
I_{SM}	Pulsed Source Current ^① (Body Diode)			108	
V_{SD}	Diode Forward Voltage ^② ($V_{GS} = 0V, I_S = -I_D [\text{Cont.}]$)			1.3	Volts
dv/dt	Peak Diode Recovery dv/dt ^⑥			5	V/ns
t_{rr}	Reverse Recovery Time ($I_S = -I_D [\text{Cont.}], di/dt = 100A/\mu s$)	$T_j = 25^\circ\text{C}$		300	ns
		$T_j = 125^\circ\text{C}$		600	
Q_{rr}	Reverse Recovery Charge ($I_S = -I_D [\text{Cont.}], di/dt = 100A/\mu s$)	$T_j = 25^\circ\text{C}$	2.0		μC
		$T_j = 125^\circ\text{C}$	6.7		
I_{RRM}	Peak Recovery Current ($I_S = -I_D [\text{Cont.}], di/dt = 100A/\mu s$)	$T_j = 25^\circ\text{C}$	13		Amps
		$T_j = 125^\circ\text{C}$	22		

THERMAL CHARACTERISTICS

Symbol	Characteristic	MIN	TYP	MAX	UNIT
$R_{\theta JC}$	Junction to Case			0.24	$^\circ\text{C/W}$
$R_{\theta JA}$	Junction to Ambient			40	

① Repetitive Rating: Pulse width limited by maximum junction temperature.

② Pulse Test: Pulse width < 380 μs , Duty Cycle < 2%

③ See MIL-STD-750 Method 3471

④ Starting $T_j = +25^\circ\text{C}$, $L = 6.86\text{mH}$, $R_G = 25\Omega$, Peak $I_L = 27\text{A}$

⑤ These dimensions are equal to the TO-247 without mounting hole

⑥ $I_S \leq -I_D [\text{Cont.}], di/dt = 100\text{A}/\mu\text{s}$, $V_{DD} \leq V_{DSS}$, $T_j \leq 150^\circ\text{C}$, $R_G = 2.0\Omega$, $V_R = 200\text{V}$.

APT Reserves the right to change, without notice, the specifications and information contained herein.

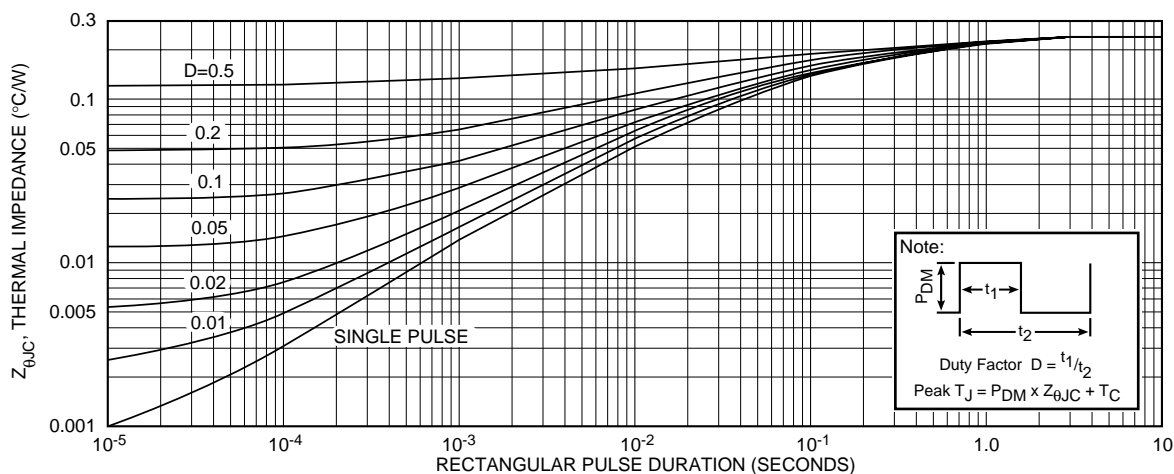

FIGURE 1, MAXIMUM EFFECTIVE TRANSIENT THERMAL IMPEDANCE, JUNCTION-TO-CASE vs PULSE DURATION

APT8030B2VFR

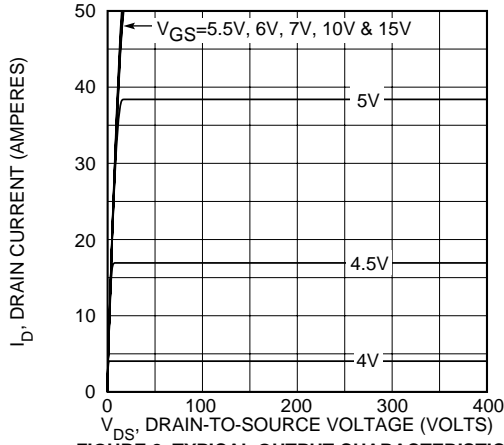

FIGURE 2, TYPICAL OUTPUT CHARACTERISTICS

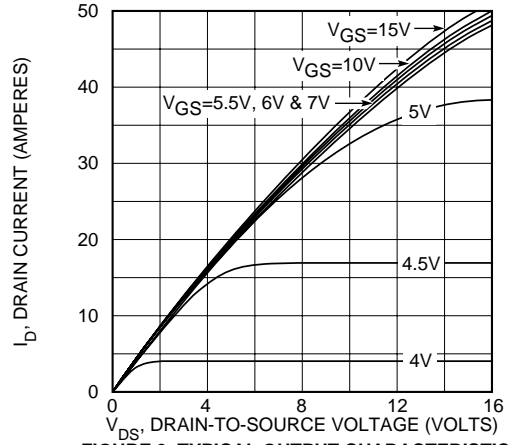

FIGURE 3, TYPICAL OUTPUT CHARACTERISTICS

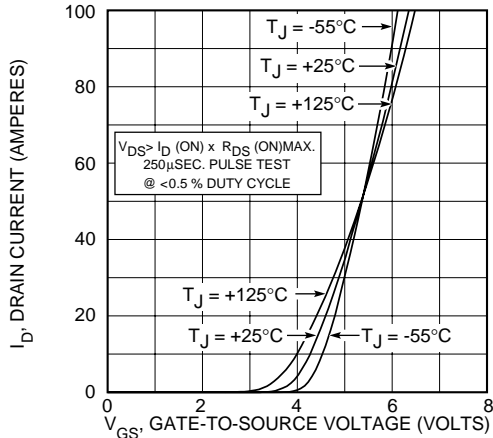

FIGURE 4, TYPICAL TRANSFER CHARACTERISTICS

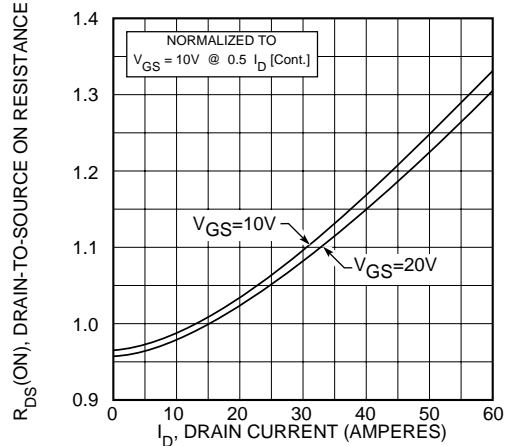

FIGURE 5, $R_{DS(ON)}$ vs DRAIN CURRENT

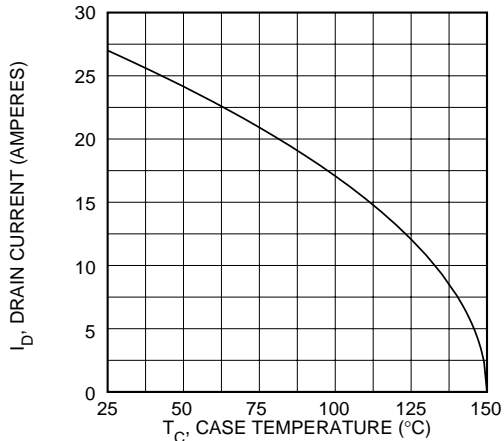

FIGURE 6, MAXIMUM DRAIN CURRENT vs CASE TEMPERATURE

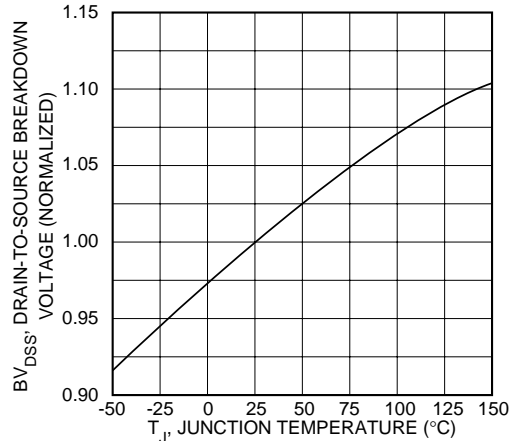

FIGURE 7, BREAKDOWN VOLTAGE vs TEMPERATURE

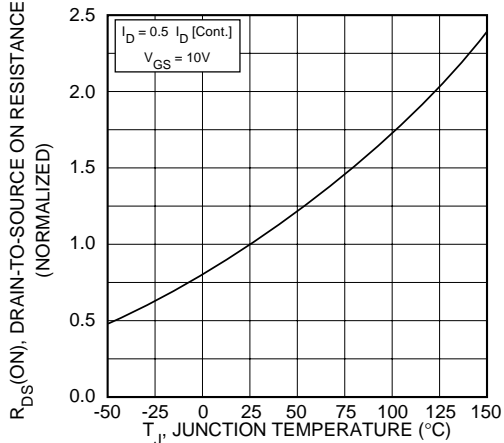

FIGURE 8, ON-RESISTANCE vs. TEMPERATURE

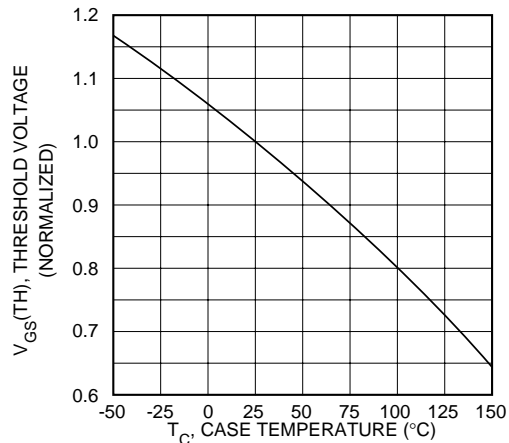

FIGURE 9, THRESHOLD VOLTAGE vs TEMPERATURE

APT8030B2VFR

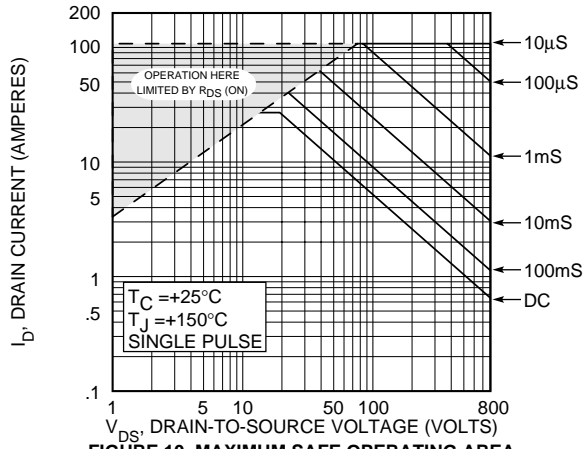

FIGURE 10, MAXIMUM SAFE OPERATING AREA

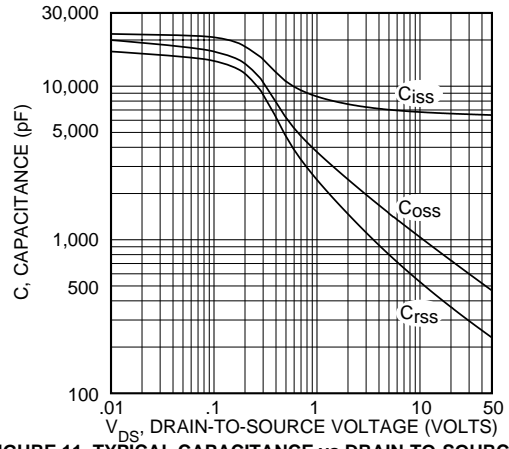

FIGURE 11, TYPICAL CAPACITANCE vs DRAIN-TO-SOURCE VOLTAGE

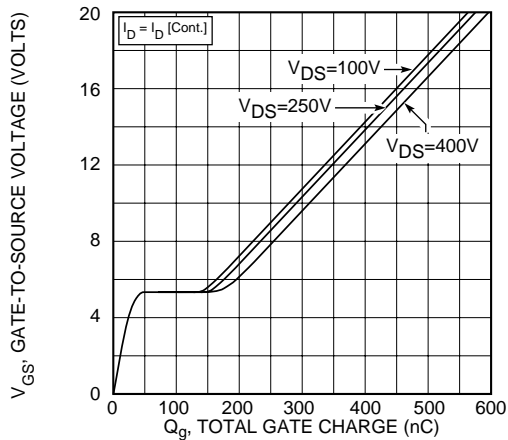

FIGURE 12, GATE CHARGES vs GATE-TO-SOURCE VOLTAGE

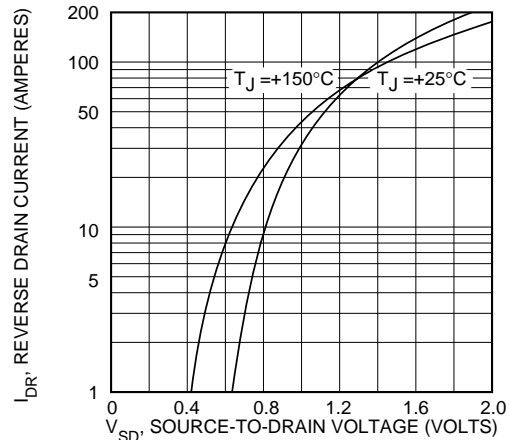
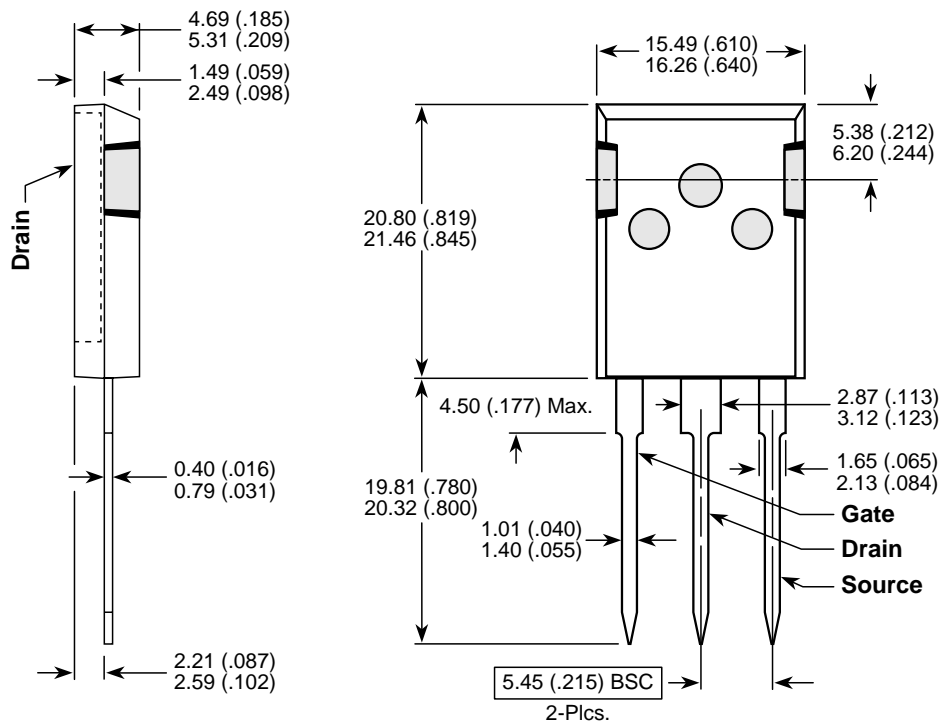

FIGURE 13, TYPICAL SOURCE-DRAIN DIODE FORWARD VOLTAGE

T-MAX™ Package Outline ⑤



Dimensions in Millimeters and (Inches)