

Super Junction MOSFET

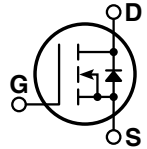

- Ultra low $R_{DS(ON)}$
- Ultra Low Gate Charge, Q_g
- Popular SOT-227 Package
- Low Miller Capacitance
- Avalanche Energy Rated
- N-Channel Enhancement Mode



Unless stated otherwise, Microsemi discrete MOSFETs contain a single MOSFET die. This device is made with two parallel MOSFET die. It is intended for switch-mode operation. It is not suitable for linear mode operation.

MAXIMUM RATINGS

All Ratings: $T_C = 25^\circ\text{C}$ unless otherwise specified.

Symbol	Parameter	APT31N80JC3	UNIT
V_{DSS}	Drain-Source Voltage	800	Volts
I_D	Continuous Drain Current @ $T_C = 25^\circ\text{C}$	31	Amps
I_{DM}	Pulsed Drain Current ^①	93	
V_{GS}	Gate-Source Voltage Continuous	± 20	Volts
V_{GSM}	Gate-Source Voltage Transient	± 30	
P_D	Total Power Dissipation @ $T_C = 25^\circ\text{C}$	833	Watts
	Linear Derating Factor	6.67	W/ $^\circ\text{C}$
T_J, T_{STG}	Operating and Storage Junction Temperature Range	-55 to 150	$^\circ\text{C}$
T_L	Lead Temperature: 0.063" from Case for 10 Sec.	300	
dv/dt	Drain-Source Voltage slope ($V_{DS} = 640\text{V}$, $I_D = 31\text{A}$, $T_J = 125^\circ\text{C}$)	50	V/ns
I_{AR}	Repetitive Avalanche Current ^⑦	17	Amps
E_{AR}	Repetitive Avalanche Energy ^⑦	0.5	mJ
E_{AS}	Single Pulse Avalanche Energy ^④	670	

STATIC ELECTRICAL CHARACTERISTICS

Symbol	Characteristic / Test Conditions	MIN	TYP	MAX	UNIT
BV_{DSS}	Drain-Source Breakdown Voltage ($V_{GS} = 0\text{V}$, $I_D = 500\mu\text{A}$)	800			Volts
$R_{DS(on)}$	Drain-Source On-State Resistance ^② ($V_{GS} = 10\text{V}$, $I_D = 22\text{A}$)		0.125	0.145	Ohms
I_{DSS}	Zero Gate Voltage Drain Current ($V_{DS} = 800\text{V}$, $V_{GS} = 0\text{V}$)		0.5	25	μA
	Zero Gate Voltage Drain Current ($V_{DS} = 800\text{V}$, $V_{GS} = 0\text{V}$, $T_J = 150^\circ\text{C}$)			250	
I_{GSS}	Gate-Source Leakage Current ($V_{GS} = \pm 20\text{V}$, $V_{DS} = 0\text{V}$)			± 200	nA
$V_{GS(th)}$	Gate Threshold Voltage ($V_{DS} = V_{GS}$, $I_D = 2\text{mA}$)	2.10	3	3.9	Volts

 **CAUTION:** These Devices are Sensitive to Electrostatic Discharge. Proper Handling Procedures Should Be Followed.

Microsemi Website - <http://www.microsemi.com>

"COOLMOS" comprise a new family of transistors developed by Infineon Technologies AG. "COOLMOS" is a trademark of Infineon Technologies AG"

DYNAMIC CHARACTERISTICS

APT31N80JC3

Symbol	Characteristic	Test Conditions	MIN	TYP	MAX	UNIT
C_{iss}	Input Capacitance	$V_{GS} = 0V$ $V_{DS} = 25V$ $f = 1\text{ MHz}$		4510		pF
C_{oss}	Output Capacitance			2050		
C_{rss}	Reverse Transfer Capacitance			110		
Q_g	Total Gate Charge ③	$V_{GS} = 10V$ $V_{DD} = 400V$ $I_D = 31A @ 25^\circ C$		180	355	nC
Q_{gs}	Gate-Source Charge			22		
Q_{gd}	Gate-Drain ("Miller") Charge			90		
$t_{d(on)}$	Turn-on Delay Time	RESISTIVE SWITCHING $V_{GS} = 10V$ $V_{DD} = 400V$ $I_D = 31A @ 125^\circ C$ $R_G = 2.5\Omega$		25		ns
t_r	Rise Time			15		
$t_{d(off)}$	Turn-off Delay Time			70	80	
t_f	Fall Time			6	9	
E_{on}	Turn-on Switching Energy ⑥	INDUCTIVE SWITCHING @ 25^\circ C $V_{DD} = 533V, V_{GS} = 15V$ $I_D = 31A, R_G = 5\Omega$		615		μJ
E_{off}	Turn-off Switching Energy			530		
E_{on}	Turn-on Switching Energy ⑥	INDUCTIVE SWITCHING @ 125^\circ C $V_{DD} = 533V, V_{GS} = 15V$ $I_D = 31A, R_G = 5\Omega$		1025		
E_{off}	Turn-off Switching Energy			580		

SOURCE-DRAIN DIODE RATINGS AND CHARACTERISTICS

Symbol	Characteristic / Test Conditions	MIN	TYP	MAX	UNIT
I_S	Continuous Source Current (Body Diode)			31	Amps
I_{SM}	Pulsed Source Current ① (Body Diode)			93	
V_{SD}	Diode Forward Voltage ② ($V_{GS} = 0V, I_S = -31A$)		1	1.2	Volts
t_{rr}	Reverse Recovery Time ($I_S = -31A, di_S/dt = 100A/\mu s, V_R = 400V$)		855		ns
Q_{rr}	Reverse Recovery Charge ($I_S = -31A, di_S/dt = 100A/\mu s, V_R = 400V$)		30		μC
dv/dt	Peak Diode Recovery dv/dt ⑤			6	V/ns

THERMAL CHARACTERISTICS

Symbol	Characteristic	MIN	TYP	MAX	UNIT
$R_{\theta JC}$	Junction to Case			0.37	$^\circ C/W$
$R_{\theta JA}$	Junction to Ambient			62	

① Repetitive Rating: Pulse width limited by maximum junction temperature

② Pulse Test: Pulse width < 380 μs , Duty Cycle < 2%

③ See MIL-STD-750 Method 3471

④ Starting $T_j = +25^\circ C$, $L = 115.92mH$, $R_G = 25\Omega$, Peak $I_L = 3.4A$

⑤ $I_S = -31A$ $di_S/dt = 100A/\mu s$ $v_R = 480V$ $T_j = 125^\circ C$

⑥ Eon includes diode reverse recovery. See figures 18, 20.

⑦ Repetitive avalanche causes additional power losses that can be calculated as $P_{AV} = E_{AR} \cdot f$

Microsemi reserves the right to change, without notice, the specifications and information contained herein.

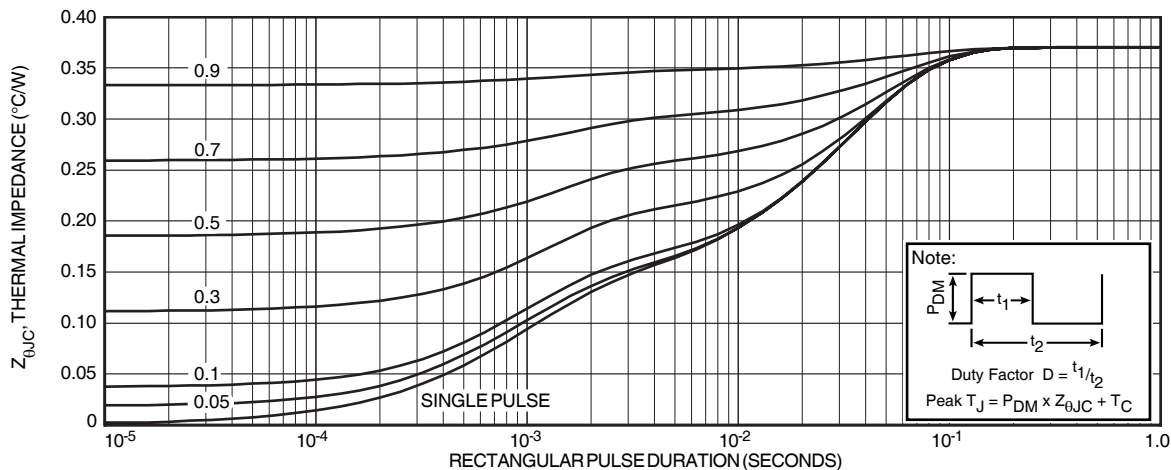

FIGURE 1, MAXIMUM EFFECTIVE TRANSIENT THERMAL IMPEDANCE, JUNCTION-TO-CASE vs PULSE DURATION

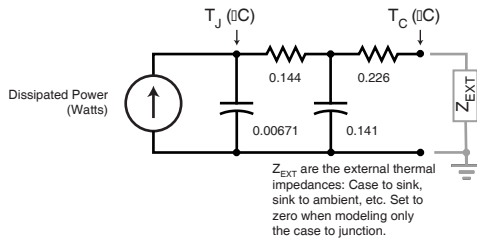

FIGURE 2, TRANSIENT THERMAL IMPEDANCE MODEL

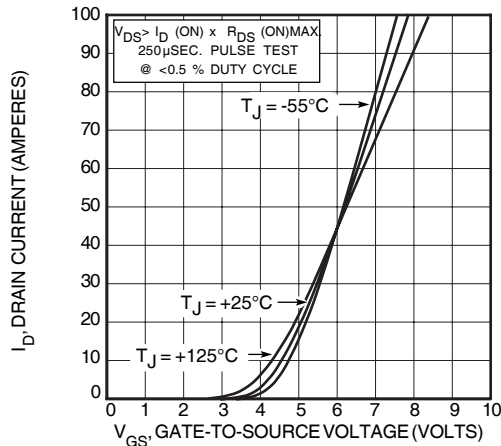

FIGURE 4, TRANSFER CHARACTERISTICS

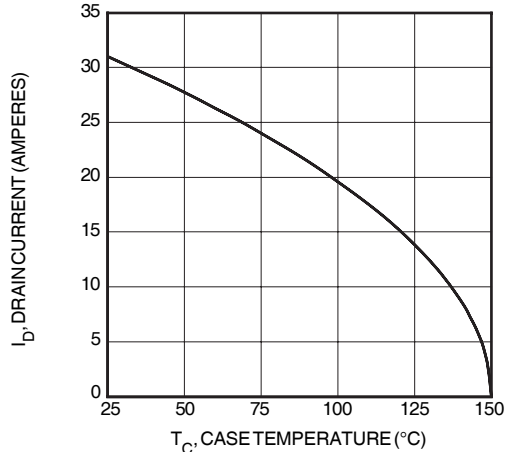

FIGURE 6, MAXIMUM DRAIN CURRENT vs CASE TEMPERATURE

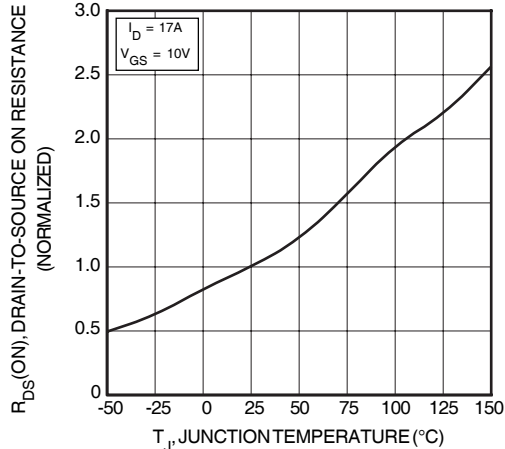

FIGURE 8, ON-RESISTANCE vs. TEMPERATURE

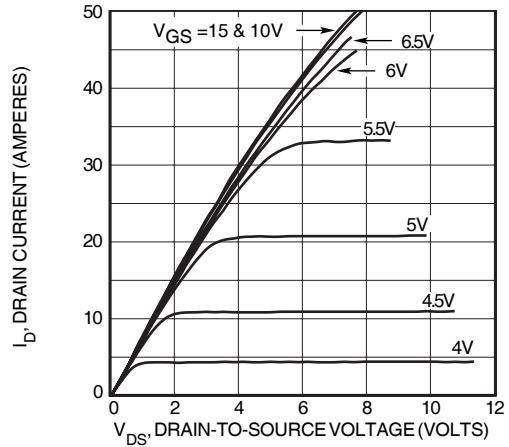

FIGURE 3, LOW VOLTAGE OUTPUT CHARACTERISTICS

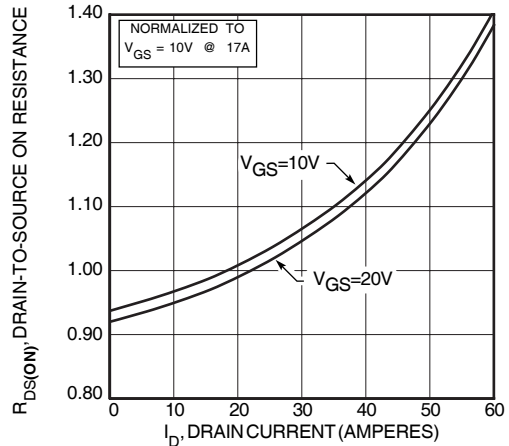

FIGURE 5, $R_{DS(ON)}$ vs DRAIN CURRENT

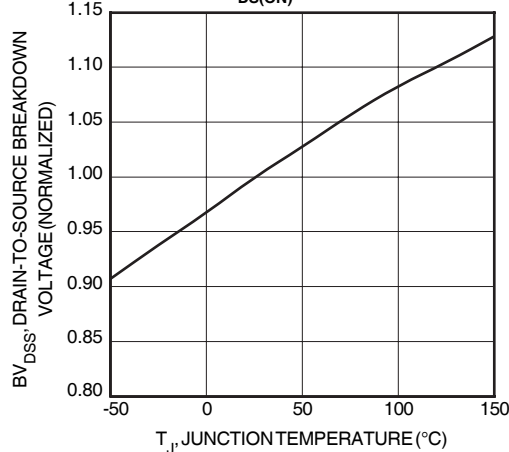

FIGURE 7, BREAKDOWN VOLTAGE vs TEMPERATURE

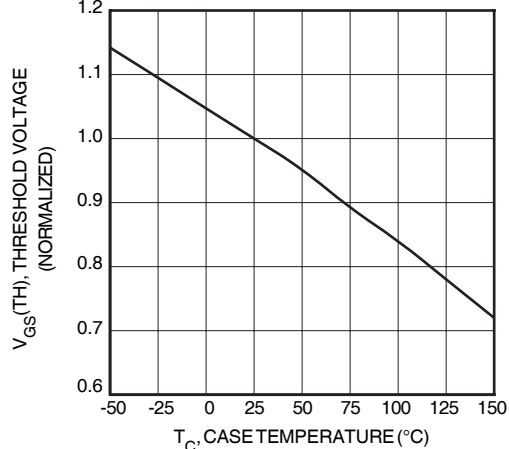

FIGURE 9, THRESHOLD VOLTAGE vs TEMPERATURE

I_D , DRAIN CURRENT (AMPERES)

Graph removed

V_{DS} , DRAIN-TO-SOURCE VOLTAGE (VOLTS)
FIGURE 10, MAXIMUM SAFE OPERATING AREA

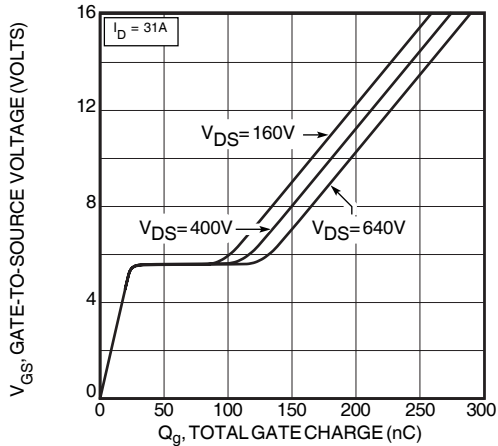

FIGURE 12, GATE CHARGES vs GATE-TO-SOURCE VOLTAGE

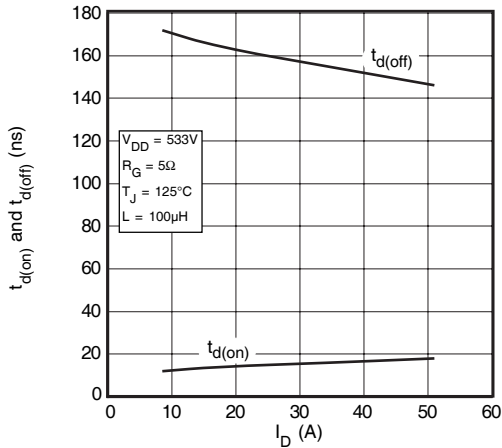

FIGURE 14, DELAY TIMES vs CURRENT

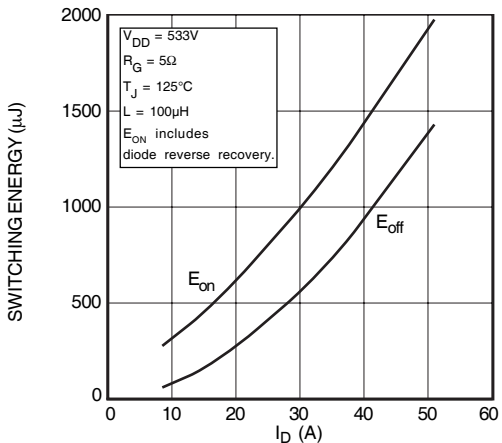

FIGURE 15, RISE AND FALL TIMES vs CURRENT

FIGURE 16, SWITCHING ENERGY vs CURRENT

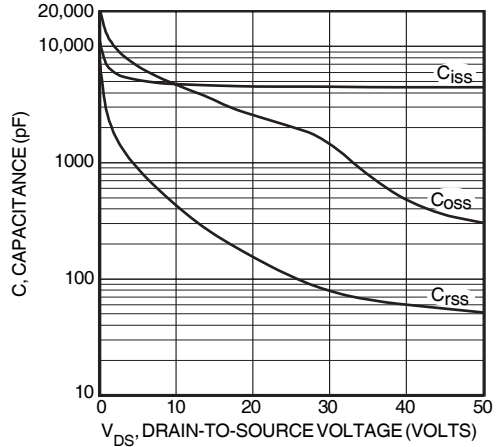

FIGURE 11, CAPACITANCE vs DRAIN-TO-SOURCE VOLTAGE

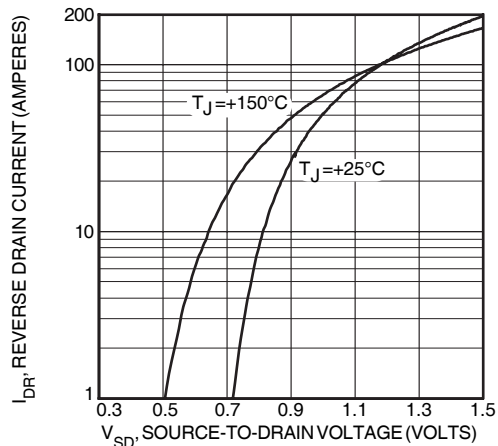

FIGURE 13, SOURCE-DRAIN DIODE FORWARD VOLTAGE

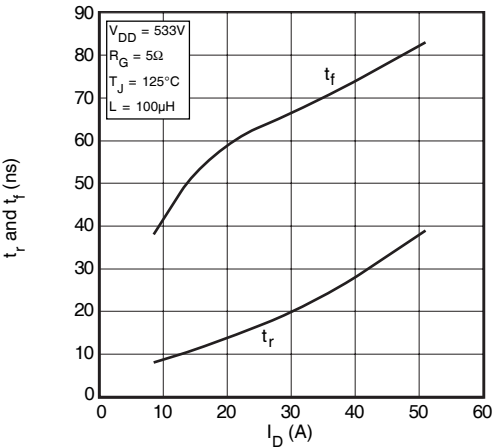

FIGURE 15, RISE AND FALL TIMES vs CURRENT

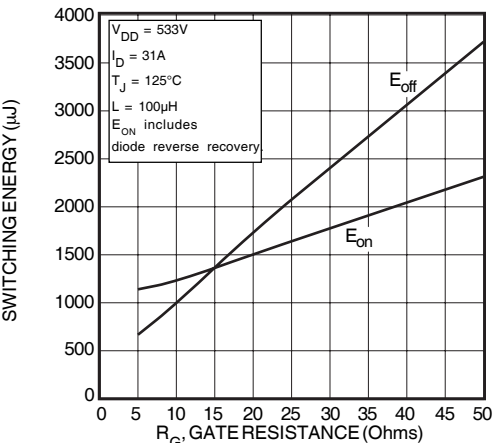

FIGURE 17, SWITCHING ENERGY VS. GATE RESISTANCE

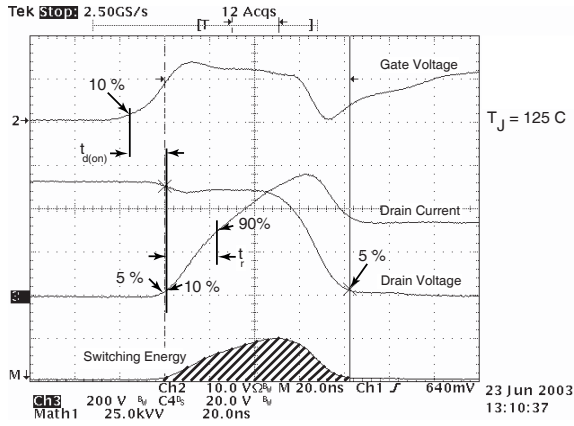

Figure 18, Turn-on Switching Waveforms and Definitions

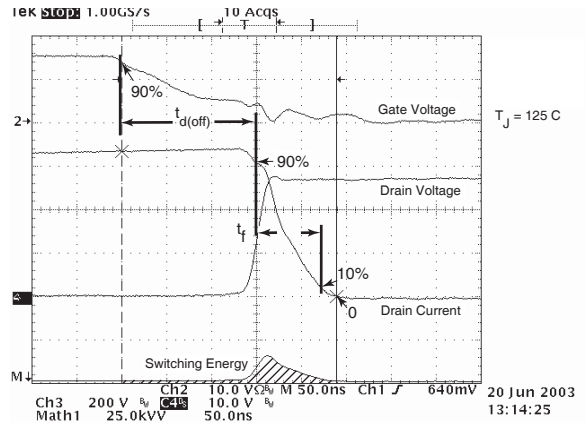

Figure 19, Turn-off Switching Waveforms and Definitions

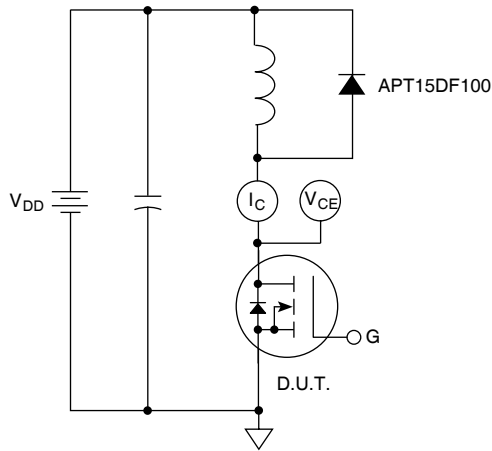
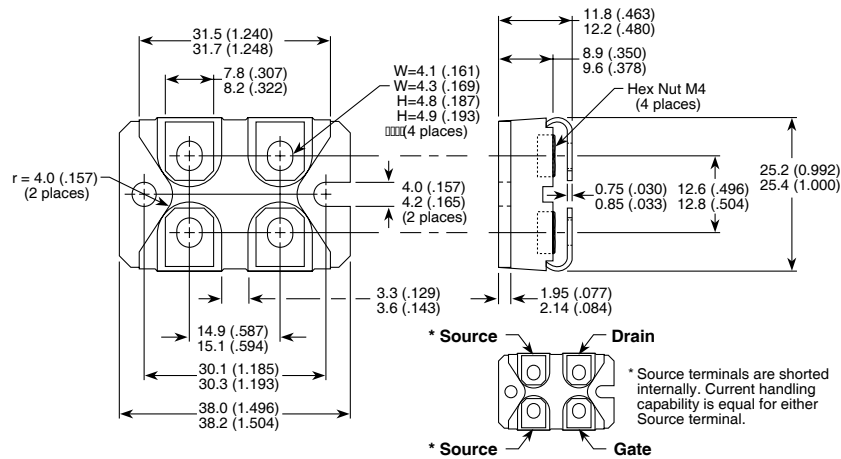

Figure 20, Inductive Switching Test Circuit

SOT-227 (ISOTOP®) Package Outline



Dimensions in Millimeters and (Inches)

ISOTOP® is a Registered Trademark of SGS Thomson. Microsemi's products are covered by one or more of U.S. patents 4,895,810 5,045,903 5,089,434 5,182,234 5,019,522 5,262,336 6,503,786 5,256,583 4,748,103 5,283,202 5,231,474 5,434,095 5,528,058 and foreign patents. US and Foreign patents pending. All Rights Reserved.