

## FEATURES

- Guaranteed  $f_{MAX} > 750\text{MHz}$  over temperature
- 1.5Gbps throughput capability
- 3.0V to 5.7V power supply
- Guaranteed  $< 700\text{ps}$  propagation delay over temperature
- Guaranteed  $< 50\text{ps}$  within-device skew over temperature
- LVDS compatible outputs
- Fully differential I/O architecture
- Wide operating temperature range:  $-40^{\circ}\text{C}$  to  $+85^{\circ}\text{C}$
- Available in a tiny 10-pin MSOP package



SuperLite™

## DESCRIPTION

The SY55855V is a fully differential, CML/PECL/LVPECL-to-LVDS translator. It achieves LVDS signaling up to 1.5Gbps, depending on the distance and the characteristics of the media and noise coupling sources. LVDS is intended to drive  $50\Omega$  impedance transmission line media such as PCB traces, backplanes, or cables.

SY55855V inputs can be terminated with a single resistor between the true and the complement pins of a given input.

The SY55855V is a member of Micrel's new SuperLite™ family of high-speed logic devices. This family features very small packaging, high signal integrity, and operation at many different supply voltages.

## FUNCTIONAL BLOCK DIAGRAM

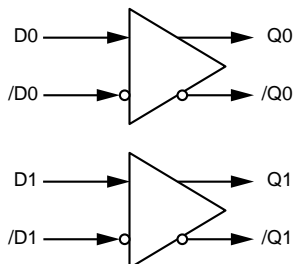

## APPLICATIONS

- High-speed logic
- Data communications systems
- Wireless communications systems
- Telecom systems

**PACKAGE/ORDERING INFORMATION**

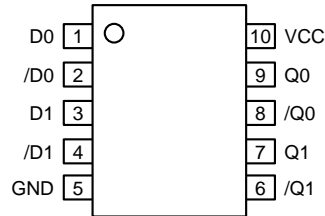

**10-Pin MSOP (K10-1)**

**Ordering Information<sup>(1)</sup>**

Part Number	Package Type	Operating Range	Package Marking	Lead Finish
SY55855VKI	K10-1	Industrial	855V	Sn-Pb
SY55855VKITR <sup>(2)</sup>	K10-1	Industrial	855V	Sn-Pb
SY55855VKG <sup>(3)</sup>	K10-1	Industrial	855V with Pb-Free bar line indicator	NiPdAu Pb-Free
SY55855VKGTR <sup>(2, 3)</sup>	K10-1	Industrial	855V with Pb-Free bar line indicator	NiPdAu Pb-Free

**Notes:**

1. Contact factory for die availability. Dice are guaranteed at T<sub>A</sub> = 25°C, DC Electricals only.
2. Tape and Reel.
3. Pb-Free package recommended for new designs.

**PIN DESCRIPTION**

Pin Number	Pin Name	Pin Function
1, 2	D0, /D0	CML/PECL/LVPECL Input (Differential). This is one of the inputs. It is converted to LVDS onto the Q0 and /Q0 outputs.
3, 4	D1, /D1	CML/PECL/LVPECL Input (Differential). This is the other input. It is converted to LVDS onto the Q1 and /Q1 outputs.
5	GND	Ground.
6, 7	/Q1, Q1	LVDS Output (Differential). This is the other LVDS output. It buffers the CML input that appears at D1, /D1.
8, 9	/Q0, Q0	LVDS Output (Differential). This is one LVDS output. It buffers the CML input that appears at D0, /D0.
10	V <sub>CC</sub>	V <sub>CC</sub>

**TRUTH TABLE**

D0	D1	Q0	/Q0	Q1	/Q1
0	0	0	1	0	1
0	1	0	1	1	0
1	0	1	0	0	1
1	1	1	0	1	0

## FUNCTIONAL DESCRIPTION

### Establishing Static Logic Inputs

The true pin of an input pair is internally biased to ground through a 75kΩ resistor. The complement pin of an input pair is internally biased halfway between  $V_{CC}$  and ground by a voltage divider consisting of two 75kΩ resistors. In this way, unconnected inputs appear as logic zeros. To keep an input at static logic zero at  $V_{CC} > 3.0V$ , leave both inputs

unconnected. For  $V_{CC} \leq 3.0V$ , connect the complement input to  $V_{CC}$  and leave the true input unconnected. To make an input static logic one, connect the true input to  $V_{CC}$ , leave the complement input unconnected. These are the only two safe ways to cause inputs to be at a static value. In particular, no input pin should be directly connected to ground. All NC (no connect) pins should be unconnected.

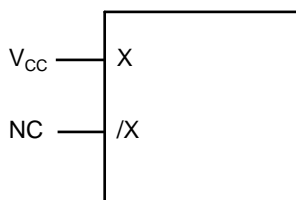

**Figure 1. Hard Wiring a Logic “1” (1)**

**Note 1.** X is either D0 or D1 input. /X is either /D0 or /D1 input.

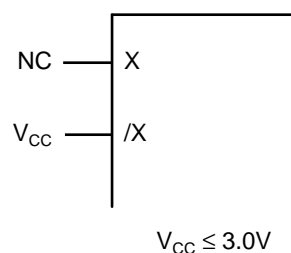
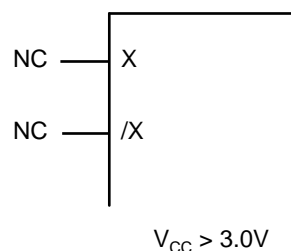

**Figure 2. Hard Wiring a Logic “0” (1)**

**Note 1.** X is either D0 or D1 input. /X is either /D0 or /D1 input.

## LVDS OUTPUTS

LVDS stands for Low Voltage Differential Swing. LVDS specifies a small swing of 350mV typical, on a nominal 1.25V common mode above ground. The common mode voltage has tight limits to permit large variations in ground between an LVDS driver and receiver. Also, change in common mode voltage, as a function of data input, is also kept tight, to keep EMI low.

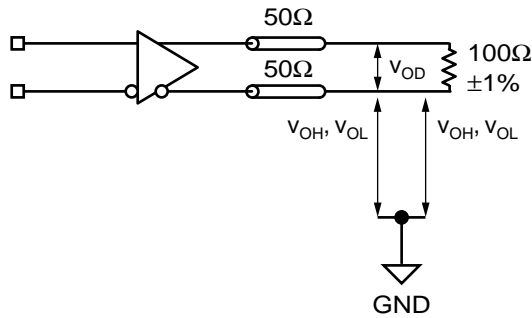

Figure 3. LVDS Differential Measurement

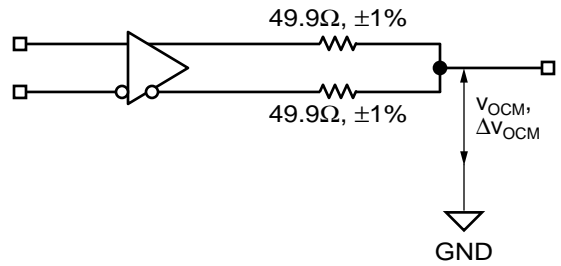

Figure 4. LVDS Common Mode Measurement

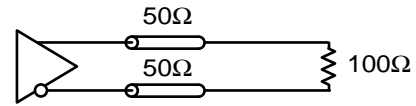

Figure 5. LVDS Output Termination

**ABSOLUTE MAXIMUM RATINGS<sup>(1)</sup>**

Symbol	Rating	Value	Unit
V <sub>CC</sub>	Power Supply Voltage	-0.5 to +6.0	V
V <sub>IN</sub>	Input Voltage	-0.5 to V <sub>CC</sub> +0.5	V
I <sub>OUT</sub>	LVDS Output Current	±10%	mA
T <sub>A</sub>	Operating Temperature Range	-40 to +85	°C
T <sub>LEAD</sub>	Lead Temperature (soldering, 20sec.)	260	°C
T <sub>store</sub>	Storage Temperature Range	-65 to +150	°C

**Note 1.** Permanent device damage may occur if absolute maximum ratings are exceeded. This is a stress rating only and functional operation is not implied at conditions other than those detailed in the operational sections of this data sheet. Exposure to absolute maximum rating conditions for extended periods may affect device reliability.

**DC ELECTRICAL CHARACTERISTICS**

V<sub>CC</sub> = 3.0V to 5.7V; GND = 0V; T<sub>A</sub> = -40°C to +85°C<sup>(2)</sup>

Symbol	Parameter	T <sub>A</sub> = -40°C		T <sub>A</sub> = +25°C			T <sub>A</sub> = +85°C		Unit
		Min.	Max.	Min.	Typ.	Max.	Min.	Max.	
V <sub>CC</sub>	Power Supply Voltage	3.0	5.7	3.0	—	5.7	3.0	5.7	V
I <sub>CC</sub>	Power Supply Current	—	80	—	—	80	—	80	mA
	3.6V < V <sub>CC</sub> < 5.7V	—	50	—	30	50	—	50	
	V <sub>CC</sub> ≤ 3.6V	—	—	—	—	—	—	—	

**CML DC ELECTRICAL CHARACTERISTICS**

V<sub>CC</sub> = 3.0V to 5.7V; GND = 0V; T<sub>A</sub> = -40°C to +85°C<sup>(2)</sup>

Symbol	Parameter	Min.	Typ.	Max.	Unit	Condition
V <sub>ID</sub>	Differential Input Voltage	100	—	—	mV	
V <sub>IH</sub>	Input HIGH Voltage	1.6	—	V <sub>CC</sub>	V	
V <sub>IL</sub>	Input LOW Voltage	1.5	—	V <sub>CC</sub> - 0.1	V	

**LVDS DC ELECTRICAL CHARACTERISTICS**

V<sub>CC</sub> = 3.0V to 5.7V; GND = 0V; T<sub>A</sub> = -40°C to +85°C<sup>(2)</sup>

Symbol	Parameter	Min.	Typ.	Max.	Unit	Condition
V <sub>OD</sub>	Differential Output Voltage <sup>(4)</sup>	250	—	450	mV	100Ω Termination
V <sub>OCM</sub>	Output Common Mode Voltage <sup>(3)</sup>	1.125	—	1.375	V	
ΔV <sub>OCM</sub>	Change in Common Mode Voltage <sup>(3)</sup>	-50	—	+50	mV	
V <sub>OH</sub>	Output HIGH Voltage <sup>(4), (5)</sup>	—	—	1.474	V	I <sub>OH</sub> = -4.0mA
V <sub>OL</sub>	Output LOW Voltage <sup>(4), (5)</sup>	0.925	—	—	V	I <sub>OL</sub> = 4.0mA

**Note 2.** Equilibrium temperature.

**Note 3.** Measured as per Figure 4.

**Note 4.** Measured as per Figure 3.

**Note 5.** Do not short output to GND.

**AC ELECTRICAL CHARACTERISTICS<sup>(1)</sup>** $V_{CC} = 3.0V$  to  $5.7V$ ;  $GND = 0V$ ;  $T_A = -40^{\circ}C$  to  $+85^{\circ}C$ <sup>(2)</sup>

Symbol	Parameter	Min.	Typ.	Max.	Unit	Condition
$f_{MAX}$	Maximum Operating Frequency	750	—	—	MHz	
$t_{PLH}$ $t_{PHL}$	Propagation Delay D0 to Q0, D1 to Q1	300	—	700	ps	
$t_{SKEW}$	Within-Device Skew <sup>(3)</sup> Part-to-Part Skew (Diff.)	—	—	50 250	ps	
$t_r$ $t_f$	LVDS Output Differential Rise/Fall Times (20% to 80%)	100	—	300	ps	

**Note 1.** Specification for packaged product only.**Note 2.** Equilibrium temperature.**Note 3.** Worst case difference between Q0 and Q1 from either D0 or D1, when both outputs have the same transition.

**EYE DIAGRAMS<sup>(1)</sup>**

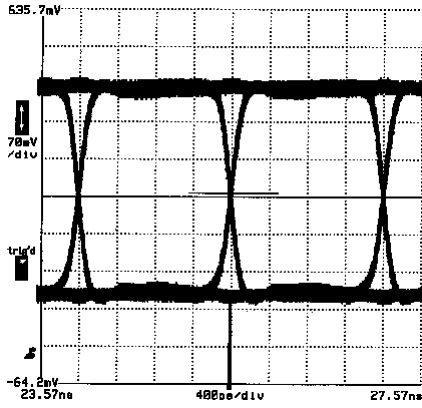

**622Mbps  
3.3V LVPECL-to-LVDS**

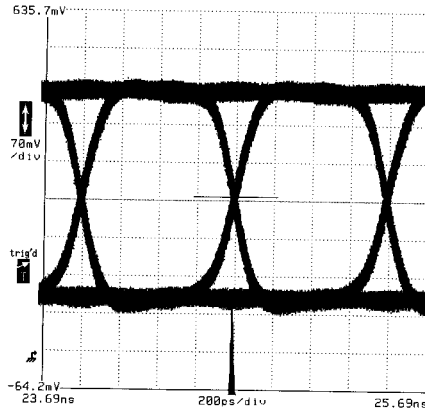

**1.25Gbps  
3.3V LVPECL-to-LVDS**

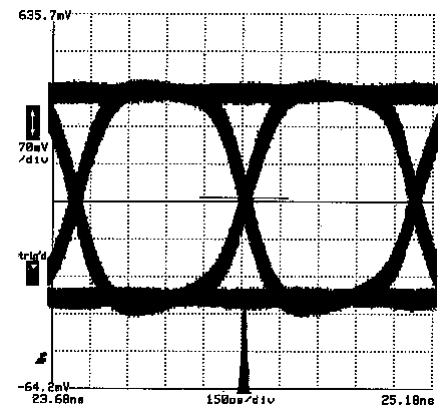

**1.5Gbps  
3.3V LVPECL-to-LVDS**

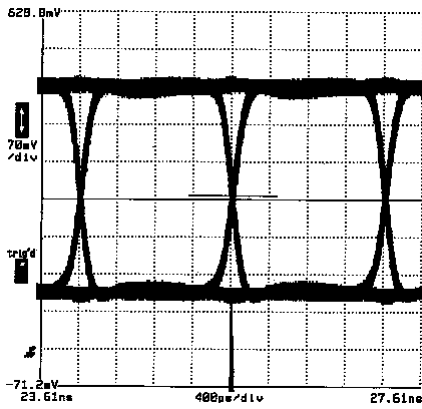

**622Mbps  
3.3V CML-to-LVDS**

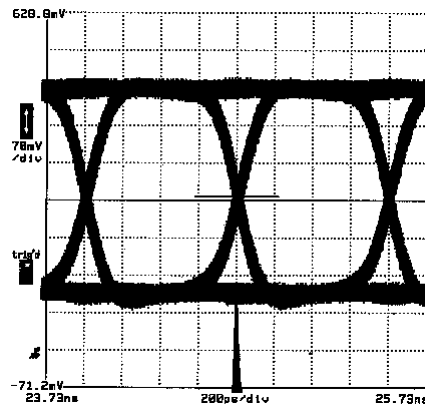

**1.25Gbps  
3.3V CML-to-LVDS**

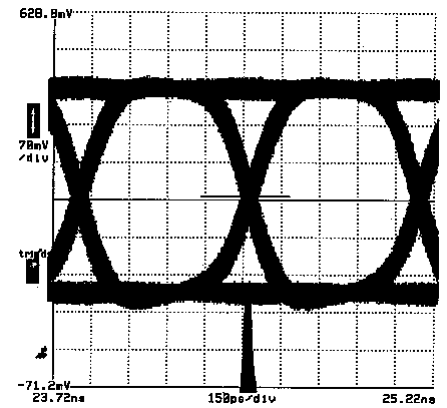

**1.5Gbps  
3.3V CML-to-LVDS**

Note 1.  $2^{23}-1$  pattern.

**10-PIN MSOP (K10-1)**

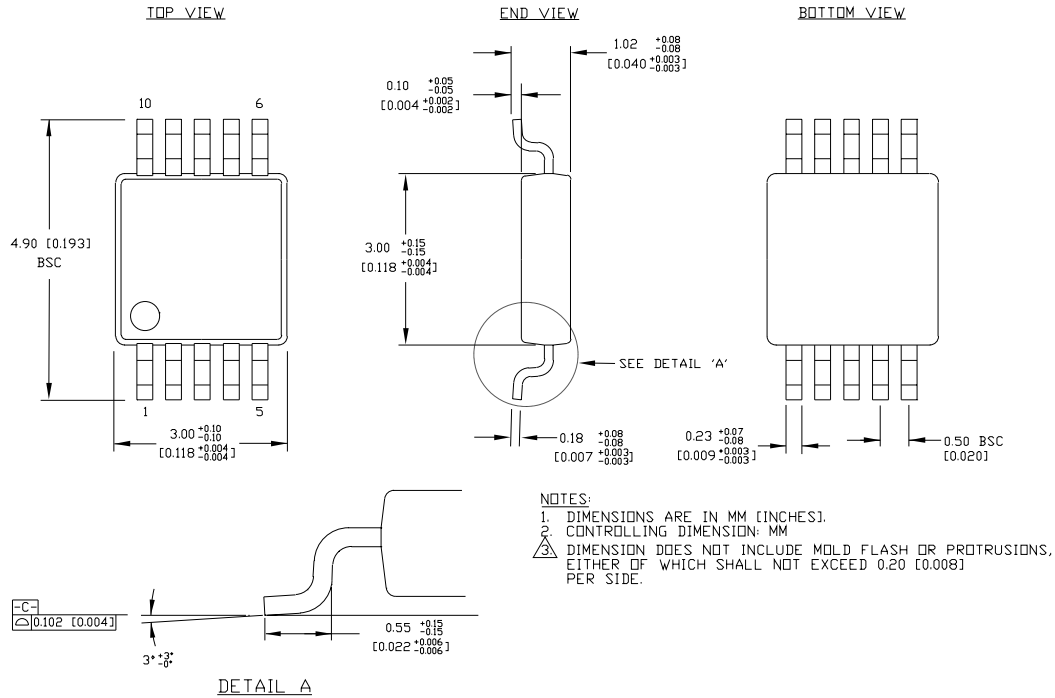

Rev. 00

**MICREL, INC. 2180 FORTUNE DRIVE SAN JOSE, CA 95131 USA**

TEL + 1 (408) 944-0800 FAX + 1 (408) 474-1000 WEB <http://www.micrel.com>

The information furnished by Micrel in this datasheet is believed to be accurate and reliable. However, no responsibility is assumed by Micrel for its use. Micrel reserves the right to change circuitry and specifications at any time without notification to the customer.

Micrel Products are not designed or authorized for use as components in life support appliances, devices or systems where malfunction of a product can reasonably be expected to result in personal injury. Life support devices or systems are devices or systems that (a) are intended for surgical implant into the body or (b) support or sustain life, and whose failure to perform can be reasonably expected to result in a significant injury to the user. A Purchaser's use or sale of Micrel Products for use in life support appliances, devices or systems is at Purchaser's own risk and Purchaser agrees to fully indemnify Micrel for any damages resulting from such use or sale.

© 2005 Micrel, Incorporated.