

Table 1. Electrical Performance

Parameter	Symbol	Min.	Typ	Max	Units
Nominal Frequency ¹	F _{NOM}	12.000		60.000	MHz
Mode		Fundamental, AT - Cut			
Operating Temperature Range, <i>ordering option</i>	T _{OP}	0/70, -10/70, -20/70, -40/85			°C
Stability Over T _{OP} ² , <i>ordering option</i>	F _{STAB}	±10		±100	ppm
Frequency Tolerance ^{2,3}	F _{TOL}		±10	±20	ppm
Load Capacitance, <i>ordering option</i>	C _L	6		32	pF
Shunt Capacitance	C _o			5	pF
Drive Level			10	100	uW
Aging / 1st year (at 25 °C)	F _{AGE}			±5	ppm
Insulation Resistance		500			MOhm
Storage Temperature	T _{STO}	-40		90	°C
Equivalent Series Resistance					
Crystal Frequency	ESR				Ohm
12.000MHz-14.000MHz				100	
14.001MHz-19.000MHz				80	
19.001MHz-30.000MHz				60	
30.001MHz-60.000MHz				40	

Notes:

- Higher frequency 3rd OT crystals can be supplied, such as 114M285 and 125M000. Please contact factory with requirements.
- Referenced to the Frequency at 25 °C.
- Frequency measured at 25 °C ± 3 °C.

Product is compliant to RoHS directive and fully compatible with lead free assembly. 

Package Drawing

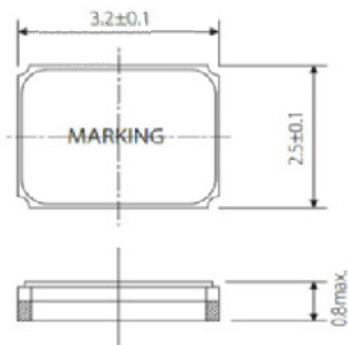

BOTTOM VIEW

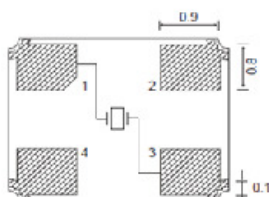

All Dimensions in mm

Marking Option 1

XXMXXX
YYWW C
were
XXMXX = Frequency
YY = Year
WW=Week
C = Manufacturing Location

Marking Option 2

VXXYM
were
V=Vectron
XX = Frequency
Y = Year
M = Month
A = January
L = December

RECOMMENDED PAD LAYOUT

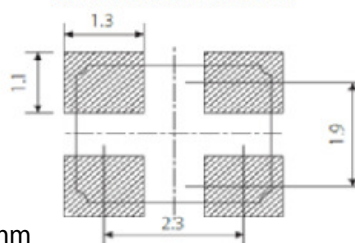

Table 2. Environmental Compliance

Parameter	Conditions
Mechanical Shock	MIL-STD-883, Method 2002, Condition B
Mechanical Vibration	MIL-STD-883, Method 2007, Condition A
Temperature Cycle	MIL-STD-883, Method 1010, Condition B
Solderability	MIL-STD-202-210, Condition B
Gross and Fine Leak	MIL-STD-883, Method 1014
Altitude	MIL-STD-883, Method 1001, Condition B
Moisture Sensitivity Level	MSL 1
Contact Pads	Gold (0.2 um min) over Nickel
Weight	20 mg

Reliability & IR Compliance

Solderprofile:

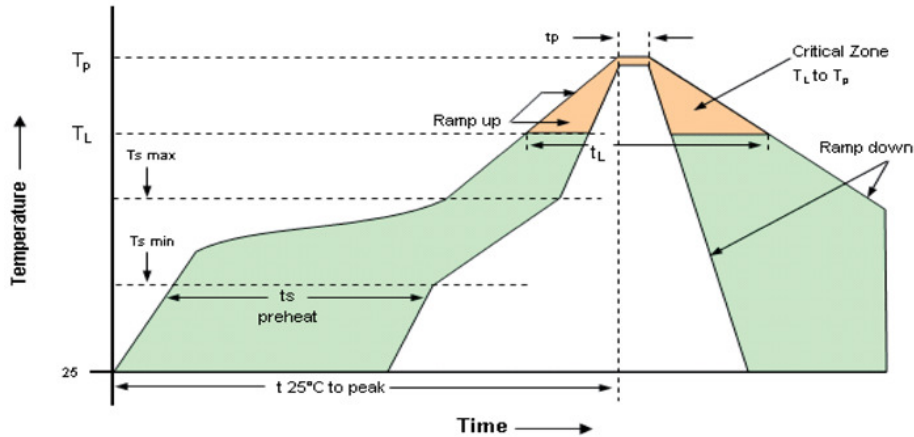

Table 3: Reflow Profile

Parameter	Symbol	Value
PreHeat Time Ts-min Ts-max	t_s	60 sec Min, 260 sec Max 150°C 200°C
Ramp Up	R_{UP}	3 °C/sec Max
Time Above 217 °C	t_L	60 sec Min, 150 sec Max
Time To Peak Temperature	T_{AMB-P}	480 sec Max
Time at 260 °C	t_p	30 sec Max
Ramp Down	R_{DN}	6 °C/sec Max

Pads are Au over Ni and compatible with either SnPb or Pb free attachment.

MSL: 1

Tape & Reel

Table 4. Tape and Reel Dimensions (mm)

Tape												Reel							
A	B	C	D	E	F	G	H	J	K	L	M	A	B	C	D	E	W	T	
3.6	2.9	8.0	3.5	1.75	4.0	4.0	2.0	0.5	1.55	0.25	1.0	180	60	21.0	13.0	2.0	9.0	2.0	

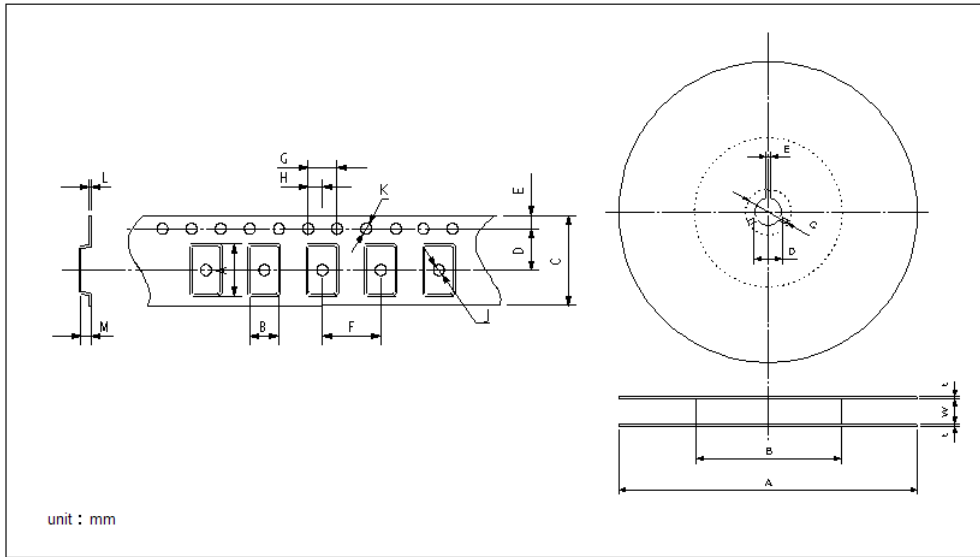

1K pieces per reel

Ordering Information

VXM7 - XXX - XX- xxMxxxxxxxx

Product
3.2 x 2.5mm, Crystal

Mode
1: Fundamental

Temp Stability
C: 10ppm
D: 15ppm
E: 20ppm
F: 25ppm
G: 30ppm
H: 35ppm
I: 40ppm
J: 45ppm
K: 50ppm
S: 100ppm

Frequency in MHz

Load Capacitance
 0: Series Resonance
 06-32pF

Operating Temperature
E: -40 to 85 °C
J: -20 to 70 °C
W: -10 to 70 °C
T: 0 to 70 °C

**Note: not all combination of options are available.
 Other specifications may be available upon request.*

10ppm stability not available for -40 to 85°C

* Add **_SNPB** for tin lead solder dip
 Example: **VXM7-1KE-18-26M0000000_SNPB**

Revision History

Revision Date	Approved	Description
December 5, 2016	RC	Updated ESR Table
August 29, 2016	RC	Initial datasheet for factory approval and release to customer.
September 18, 2018	FB	Update logo and contact information, add 1K reel pieces per reel and "SNPBDIP" ordering option
June 7, 2019	FB	Update logo and contact information, add Table 2 Environmental compliance, change "SNPBDIP" to "SNPB"

**Previous Ordering Information for Reference Only
Do Not Use to Build a New Part Number**

VXM7-1M2-10M000

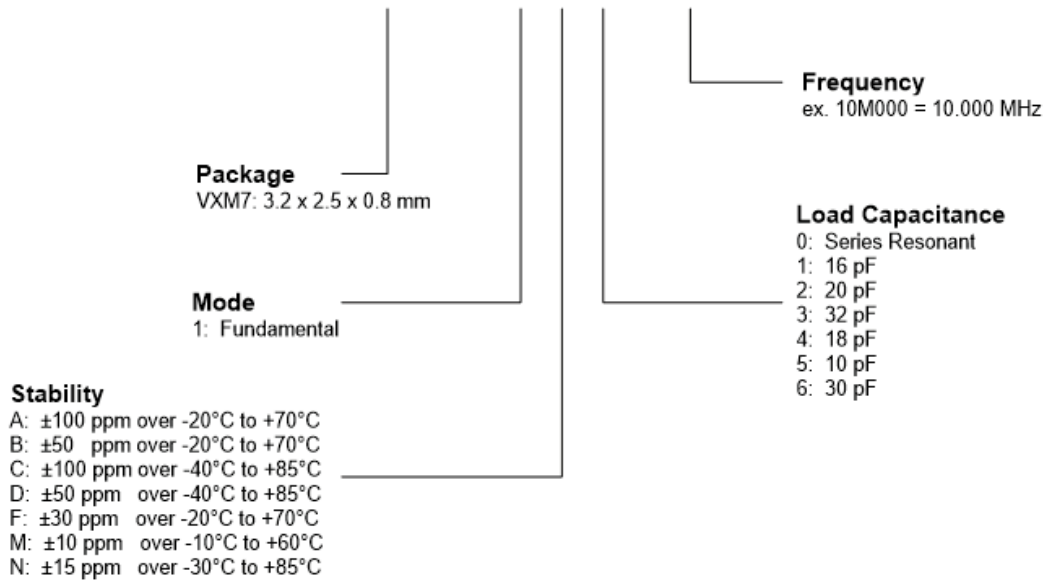

The ordering codes for the VXM7 were changed in 2016. If you had ordered a specific code based off this ordering method, it is still available for purchase under the old code however no new part numbers will be created using this system.

Due to the change in the 8th character from numeric to alphabetic, there is no opportunity for overlap between the two ordering methods.

Contact Information

USA:

100 Watts Street
 Mt Holly Springs, PA 17065
 Tel: 1.717.486.3411
 Fax: 1.717.486.5920

Europe:

Landstrasse
 74924 Neckarbischofsheim
 Germany
 Tel: +49 (0) 7268.801.0
 Fax: +49 (0) 7268.801.281



Information contained in this publication regarding device applications and the like is provided only for your convenience and may be superseded by updates. It is your responsibility to ensure that your application meets with your specifications. MICROCHIP MAKES NO REPRESENTATION OR WARRANTIES OF ANY KIND WHETHER EXPRESS OR IMPLIED, WRITTEN OR ORAL, STATUTORY OR OTHERWISE, RELATED TO THE INFORMATION INCLUDING, BUT NOT LIMITED TO ITS CONDITION, QUALITY, PERFORMANCE, MERCHANTABILITY OR FITNESS FOR PURPOSE. Microchip disclaims all liability arising from this information and its use. Use of Microchip devices in life support and/or safety applications is entirely at the buyer's risk, and the buyer agrees to defend, indemnify and hold harmless Microchip from any and all damages, claims, suits, or expenses resulting from such use. No licenses are conveyed, implicitly, or otherwise, under any Microchip intellectual property rights unless otherwise stated.

Trademarks

The Microchip and Vectron names and logos are registered trademarks of Microchip Technology Incorporated in the U.S.A. and other countries.