

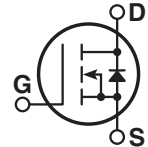

## Super Junction MOSFET

- Ultra Low  $R_{DS(on)}$
- Low Miller Capacitance
- Ultra Low Gate Charge,  $Q_g$
- Avalanche Energy Rated
- Extreme  $dv/dt$  Rated

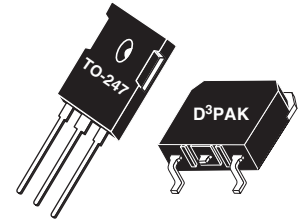

### MAXIMUM RATINGS

All Ratings per die:  $T_C = 25^\circ\text{C}$  unless otherwise specified.

Symbol	Parameter	APT30N60B_SC6	UNIT
$V_{DSS}$	Drain-Source Voltage	600	Volts
$I_D$	Continuous Drain Current @ $T_C = 25^\circ\text{C}$	30	Amps
	Continuous Drain Current @ $T_C = 100^\circ\text{C}$	19	
$I_{DM}$	Pulsed Drain Current <sup>1</sup>	89	
$V_{GS}$	Total Power Dissipation @ $T_C = 25^\circ\text{C}$	$\pm 20$	Volts
$P_D$	Gate-Source Voltage Continuous	219	Watts
$T_J, T_{STG}$	Operating and Storage Junction Temperature Range	- 55 to 150	$^\circ\text{C}$
$T_L$	Lead Temperature: 0.063" from Case for 10 Sec.	260	
$dv/dt$	Drain-Source Voltage slope ( $V_{DS} = 480\text{V}$ , $I_D = 30\text{A}$ , $T_J = 125^\circ\text{C}$ )	15	V/ns
$I_{AR}$	Avalanche Current <sup>2</sup>	5.2	Amps
$E_{AR}$	Repetitive Avalanche Energy <sup>2</sup> ( $I_d = 5.2\text{A}$ , $V_{dd} = 50\text{V}$ )	0.96	mJ
$E_{AS}$	Single Pulse Avalanche Energy ( $I_d = 5.2\text{A}$ , $V_{dd} = 50\text{V}$ )	636	

### STATIC ELECTRICAL CHARACTERISTICS

Symbol	Characteristic / Test Conditions	MIN	TYP	MAX	UNIT
$BV_{(DSS)}$	Drain-Source Breakdown Voltage ( $V_{GS} = 0\text{V}$ , $I_D = 250\mu\text{A}$ )	600			Volts
$R_{DS(on)}$	Drain-Source On-State Resistance <sup>3</sup> ( $V_{GS} = 10\text{V}$ , $I_D = 14.5\text{A}$ )		0.11	0.125	Ohms
$I_{DSS}$	Zero Gate Voltage Drain Current ( $V_{DS} = 600\text{V}$ , $V_{GS} = 0\text{V}$ )			25	$\mu\text{A}$
	Zero Gate Voltage Drain Current ( $V_{DS} = 600\text{V}$ , $V_{GS} = 0\text{V}$ , $T_C = 150^\circ\text{C}$ )			100	
$I_{GSS}$	Gate-Source Leakage Current ( $V_{GS} = \pm 20\text{V}$ , $V_{DS} = 0\text{V}$ )			$\pm 100$	nA
$V_{GS(th)}$	Gate Threshold Voltage ( $V_{DS} = V_{GS}$ , $I_D = 960\mu\text{A}$ )	2.5	3	3.5	Volts

 CAUTION: These Devices are Sensitive to Electrostatic Discharge. Proper Handling Procedures Should Be Followed.

"COOLMOS™ comprise a new family of transistors developed by Infineon Technologies AG. "COOLMOS" is a trademark of Infineon Technologies AG."

Microsemi Website - <http://www.microsemi.com>

Symbol	Characteristic	Test Conditions	MIN	TYP	MAX	UNIT
C <sub>iss</sub>	Input Capacitance	V <sub>GS</sub> = 0V V <sub>DS</sub> = 25V f = 1 MHz		2267		pF
C <sub>oss</sub>	Output Capacitance			1990		
C <sub>rss</sub>	Reverse Transfer Capacitance			203		
Q <sub>g</sub>	Total Gate Charge <sup>4</sup>	V <sub>GS</sub> = 10V V <sub>DD</sub> = 300V I <sub>D</sub> = 30A @ 25°C		88		nC
Q <sub>gs</sub>	Gate-Source Charge			12		
Q <sub>gd</sub>	Gate-Drain ("Miller") Charge			46		
t <sub>d(on)</sub>	Turn-on Delay Time	<b>INDUCTIVE SWITCHING</b> V <sub>GS</sub> = 15V V <sub>DD</sub> = 400V I <sub>D</sub> = 30A @ 25°C R <sub>G</sub> = 4.3Ω		9		ns
t <sub>r</sub>	Rise Time			17		
t <sub>d(off)</sub>	Turn-off Delay Time			74		
t <sub>f</sub>	Fall Time			48		
E <sub>on</sub>	Turn-on Switching Energy <sup>5</sup>	<b>INDUCTIVE SWITCHING @ 25°C</b> V <sub>DD</sub> = 400V, V <sub>GS</sub> = 15V I <sub>D</sub> = 30A, R <sub>G</sub> = 4.3Ω		409		μJ
E <sub>off</sub>	Turn-off Switching Energy			224		
E <sub>on</sub>	Turn-on Switching Energy <sup>5</sup>	<b>INDUCTIVE SWITCHING @ 125°C</b> V <sub>DD</sub> = 400V, V <sub>GS</sub> = 15V I <sub>D</sub> = 30A, R <sub>G</sub> = 4.3Ω		649		
E <sub>off</sub>	Turn-off Switching Energy			282		

SOURCE-DRAIN DIODE RATINGS AND CHARACTERISTICS

Symbol	Characteristic / Test Conditions	MIN	TYP	MAX	UNIT
I <sub>S</sub>	Continuous Source Current (Body Diode)		26		Amps
I <sub>SM</sub>	Pulsed Source Current <sup>1</sup> (Body Diode)		65		Amps
V <sub>SD</sub>	Diode Forward Voltage <sup>3</sup> (V <sub>GS</sub> = 0V, I <sub>S</sub> = -30A)			1.30	Volts
dv/dt	Peak Diode Recovery dv/dt <sup>6</sup>		15		V/ns
t <sub>rr</sub>	Reverse Recovery Time (I <sub>S</sub> = -30A, di/dt = 100A/μs)	T <sub>J</sub> = 25°C	661		ns
		T <sub>J</sub> = 125°C	813		
Q <sub>rr</sub>	Reverse Recovery Charge (I <sub>S</sub> = -30A, di/dt = 100A/μs)	T <sub>J</sub> = 25°C	15		μC
		T <sub>J</sub> = 125°C	18		
I <sub>RRM</sub>	Peak Recovery Current (I <sub>S</sub> = -30A, di/dt = 100A/μs)	T <sub>J</sub> = 25°C	46		Amps
		T <sub>J</sub> = 125°C	48		

THERMAL CHARACTERISTICS

Symbol	Characteristic	MIN	TYP	MAX	UNIT
R <sub>θJC</sub>	Junction to Case			0.52	°C/W
R <sub>θJA</sub>	Junction to Ambient			31	

- 1 Repetitive Rating: Pulse width limited by maximum junction temperature
- 2 Repetitive avalanche causes additional power losses that can be calculated as  $P_{AV} = E_{AR} \cdot f$ . Pulse width tp limited by Tj max.
- 3 Pulse Test: Pulse width < 380 μs, Duty Cycle < 2%
- 4 See MIL-STD-750 Method 3471
- 5 Eon includes diode reverse recovery.
- 6 Maximum 125°C diode commutation speed = di/dt 600A/μs

Microsemi reserves the right to change, without notice, the specifications and information contained herein.

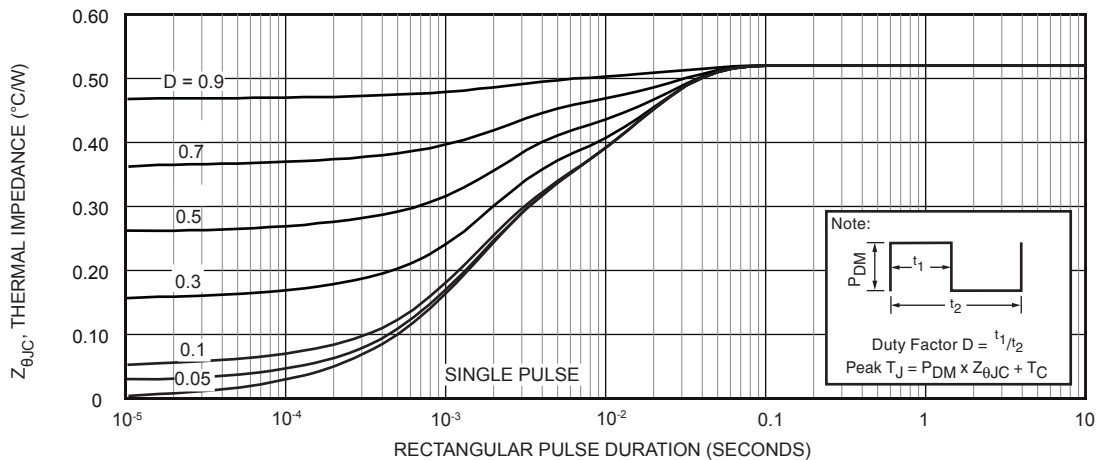

Figure 1, Maximum Effective Transient Thermal Impedance, Junction-To-Case vs Pulse Duration

Typical Performance Curves

APT30N60B\_SC6

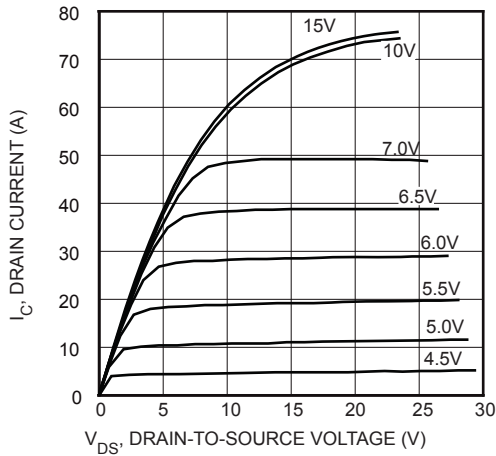

FIGURE 2, Low Voltage Output Characteristics

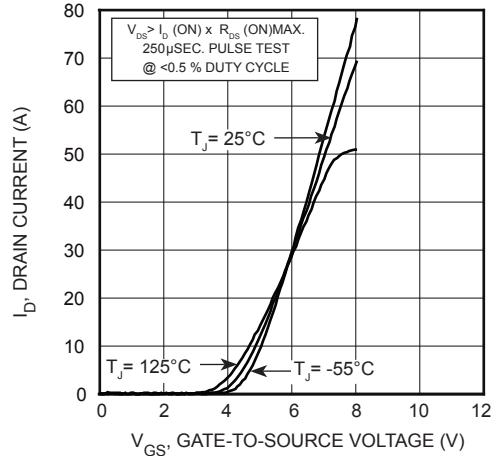

FIGURE 3, Transfer Characteristics

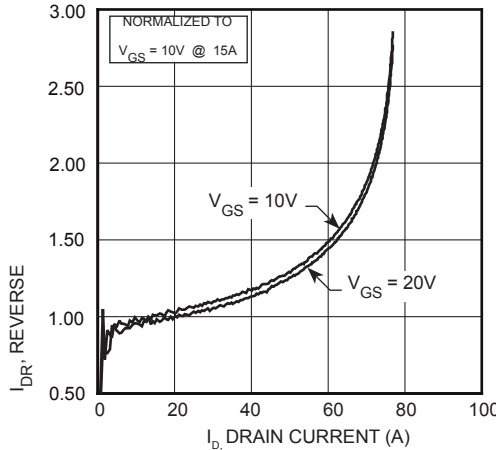

FIGURE 4,  $R_{DS(ON)}$  vs Drain Current

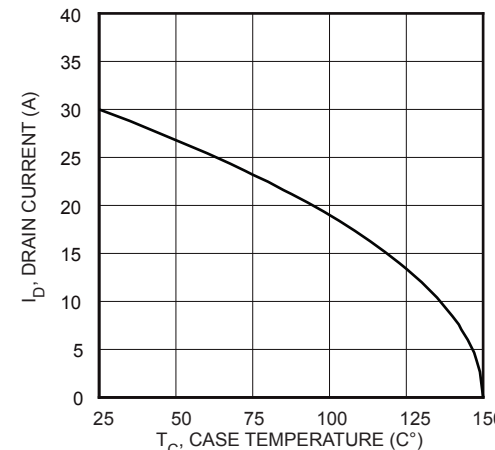

FIGURE 5, Maximum Drain Current vs Case Temperature

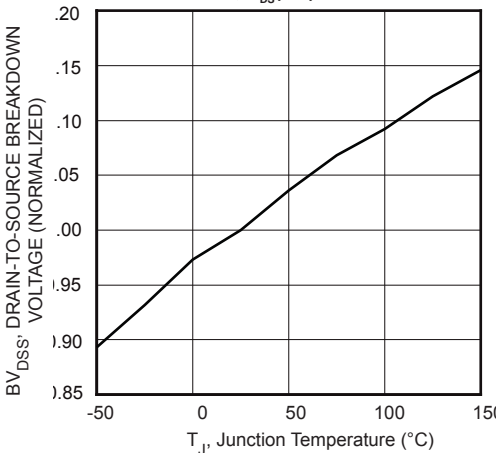

FIGURE 6, Breakdown Voltage vs Temperature

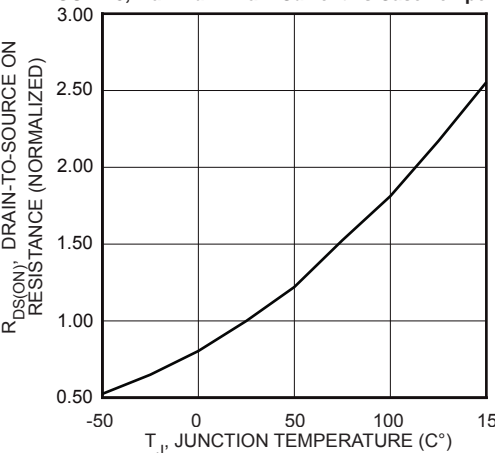

FIGURE 7, On-Resistance vs Temperature

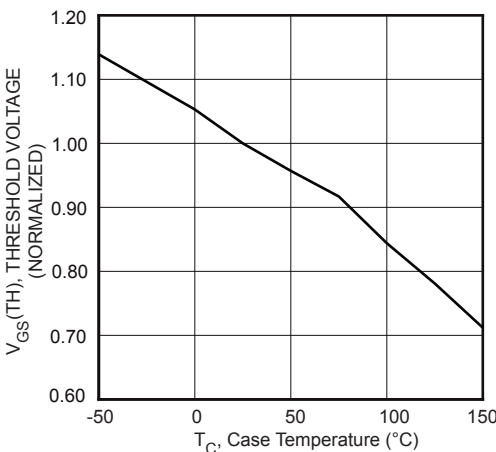

FIGURE 8, Threshold Voltage vs Temperature

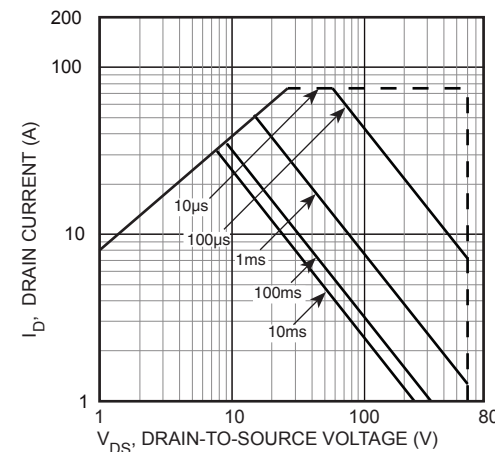

FIGURE 9, Maximum Safe Operating Area

# Typical Performance Curves

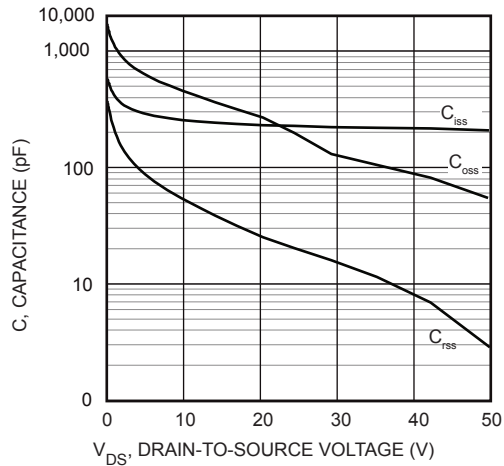

FIGURE 10, Capacitance vs Drain-To-Source Voltage

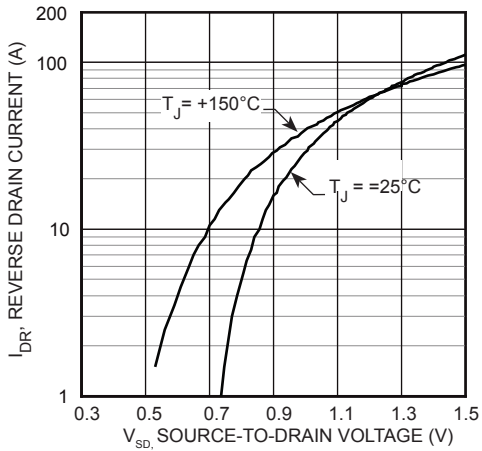

FIGURE 12, Source-Drain Diode Forward Voltage

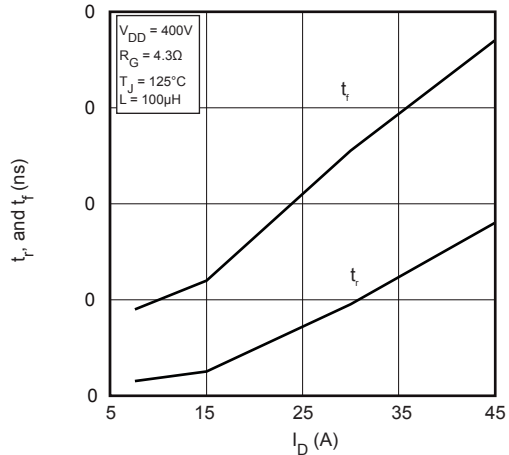

FIGURE 14, Rise and Fall Times vs Current

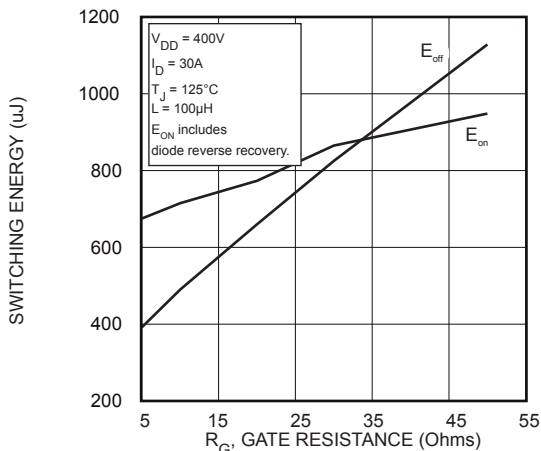

FIGURE 16, Switching Energy vs Gate Resistance

# APT30N60B\_SC6

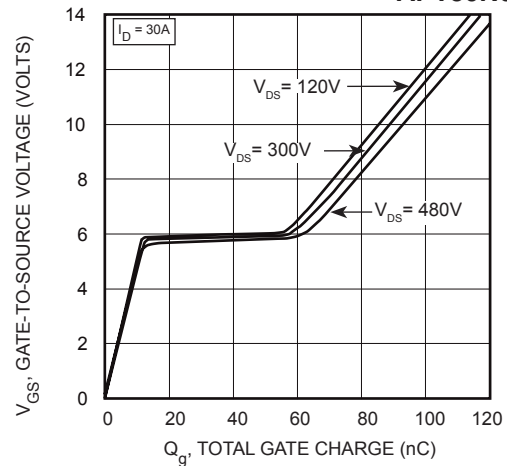

FIGURE 11, Gate Charges vs Gate-To-Source Voltage

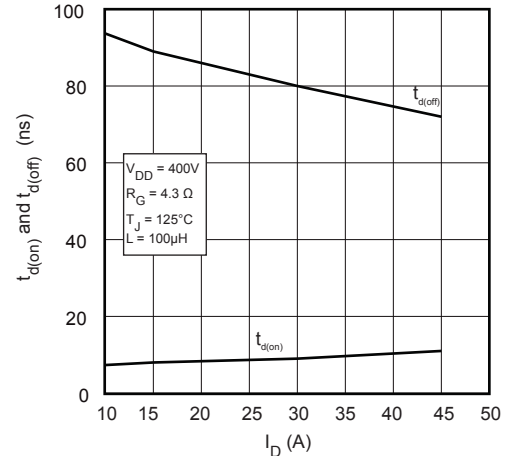

FIGURE 13, Delay Times vs Current

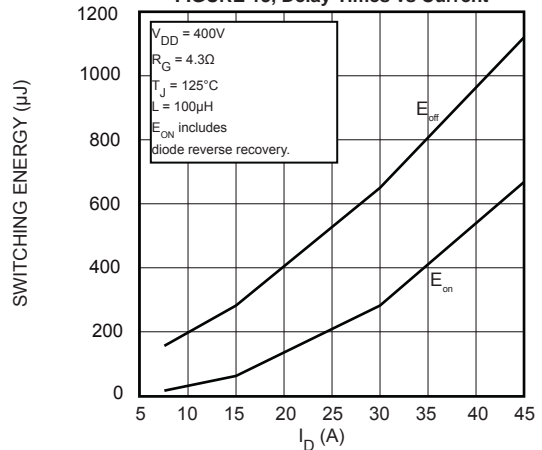

FIGURE 15, Switching Energy vs Current

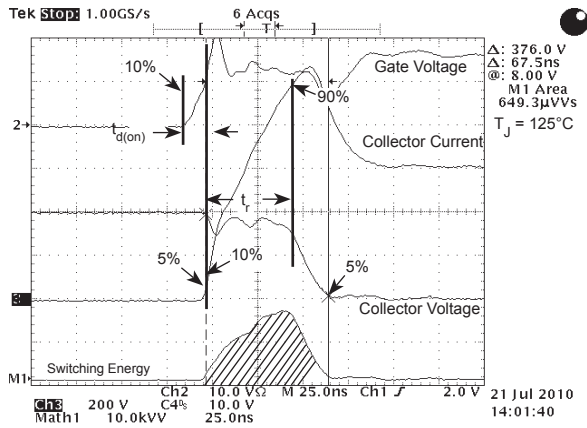

Figure 17, Turn-on Switching Waveforms and Definitions

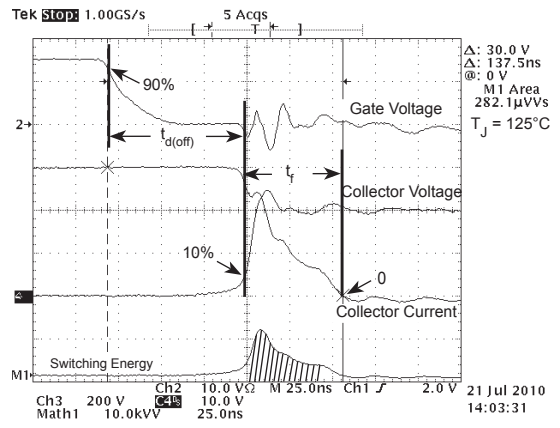

Figure 18, Turn-off Switching Waveforms and Definitions

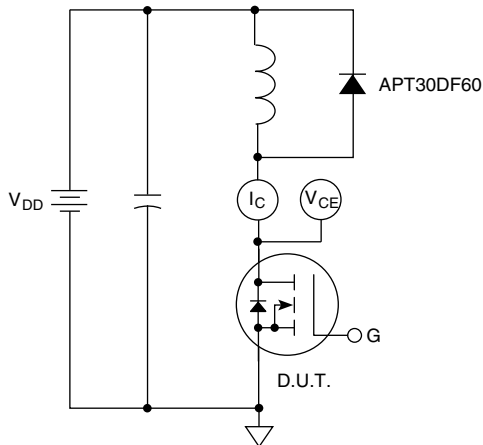
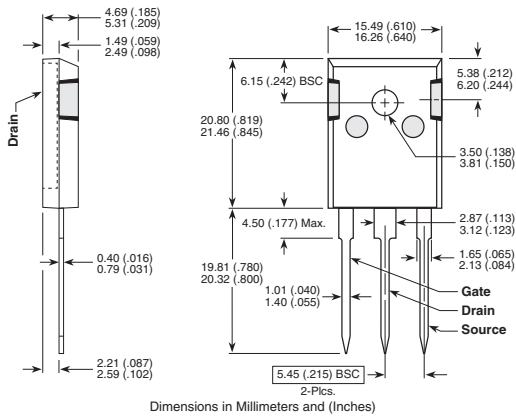

Figure 19, Inductive Switching Test Circuit

TO-247 Package Outline



Dimensions in Millimeters and (Inches)

D<sup>3</sup>PAK Package Outline

100% Sn

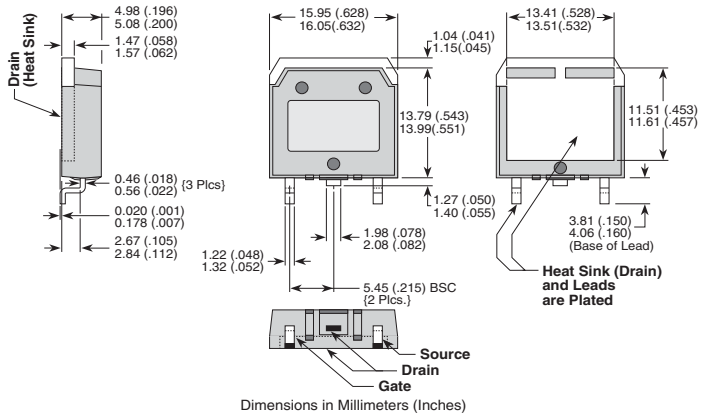

Dimensions in Millimeters (Inches)