

---

## 500 mA Peak Output LDO Regulator

---

### Features

- 500 mA Output Current Capability
  - SOT23-5 Package - 500 mA Peak
  - 2 mm x 2 mm x 0.9 mm VDFN Package - 500 mA Continuous
  - 2 mm x 2 mm x 0.6 mm Thin DFN Package - 500 mA Continuous
  - MSOP-8 Package - 500 mA Continuous
- Low 500 mV Maximum Dropout Voltage at Full Load
- Extremely Tight Load and Line Regulation
- Tiny SOT-23-5 and Power MSOP-8 Package
- Ultra-Low Noise Output
- Low Temperature Coefficient
- Current and Thermal Limiting
- Reversed-Battery Protection
- CMOS/TTL-Compatible Enable/Shutdown Control
- Near-Zero Shutdown Current

### Applications

- Laptop, Notebook, and Palmtop Computers
- Cellular Telephones and Battery-Powered Equipment
- Consumer and Personal Electronics
- PC Card  $V_{CC}$  and  $V_{PP}$  Regulation and Switching
- SMPS Post-Regulator/DC-to-DC Modules
- High-Efficiency Linear Power Supplies

### General Description

The MIC5219 is an efficient linear voltage regulator with high peak output current capability, very low dropout voltage, and better than 1% output voltage accuracy. Dropout is typically 10 mV at light loads and less than 500 mV at full load.

The MIC5219 is designed to provide a peak output current for start-up conditions where higher inrush current is demanded. It features a 500 mA peak output rating. Continuous output current is limited only by package and layout.

The MIC5219 can be enabled or shut down by a CMOS- or TTL-compatible signal. When disabled, power consumption drops nearly to zero. Dropout ground current is minimized to help prolong battery life. Other key features include reversed-battery protection, current limiting, overtemperature shutdown, and low noise performance with an ultra-low noise option.

The MIC5219 is available in adjustable or fixed output voltages in the space-saving 6-pin (2 mm × 2 mm) VDFN, 6-pin (2 mm × 2 mm) Thin DFN, SOT23-5, and 8-pin power MSOP packages. For higher power requirements see the MIC5209 or MIC5237.

# MIC5219

## Package Types

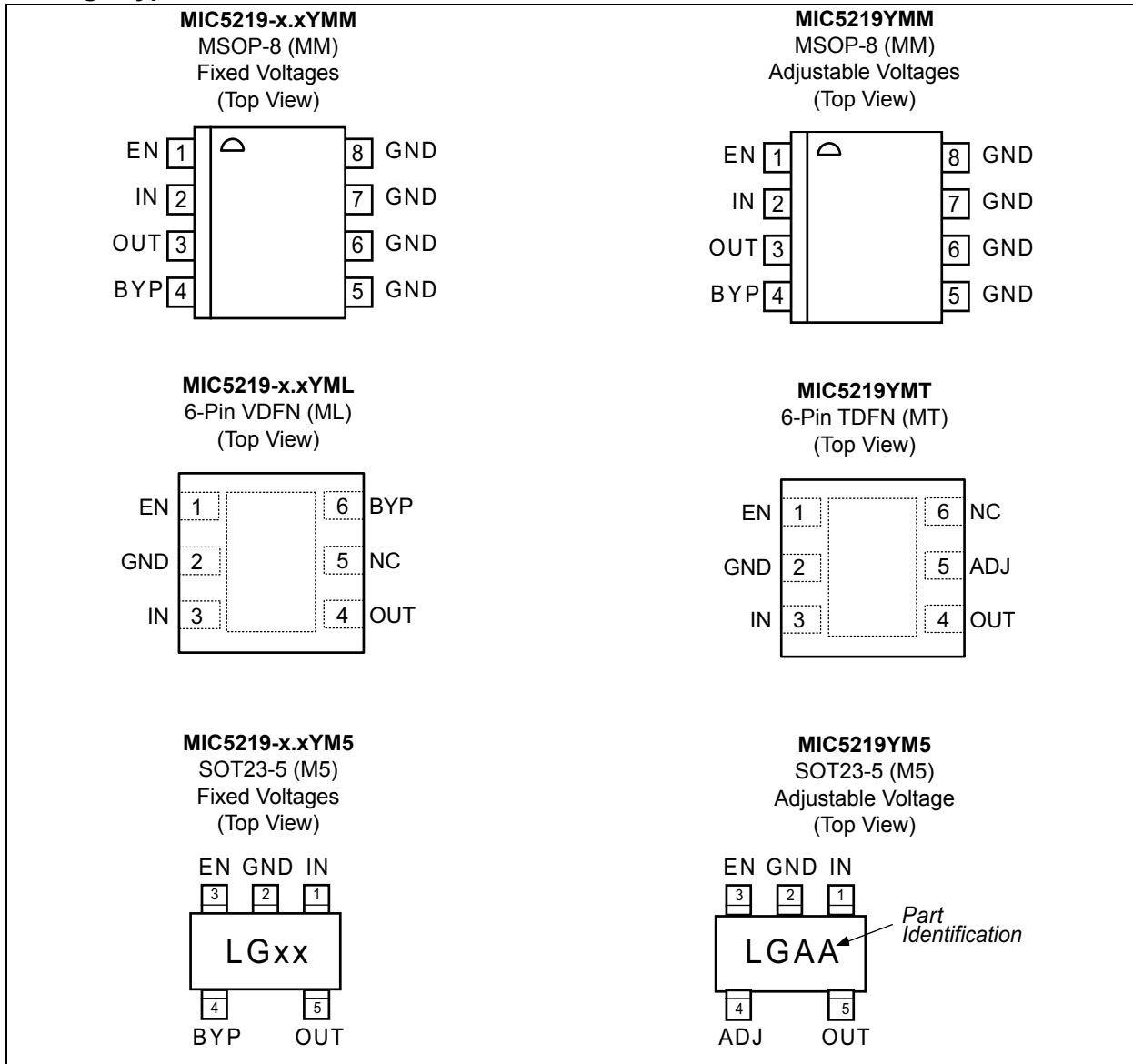

## Typical Application Circuits

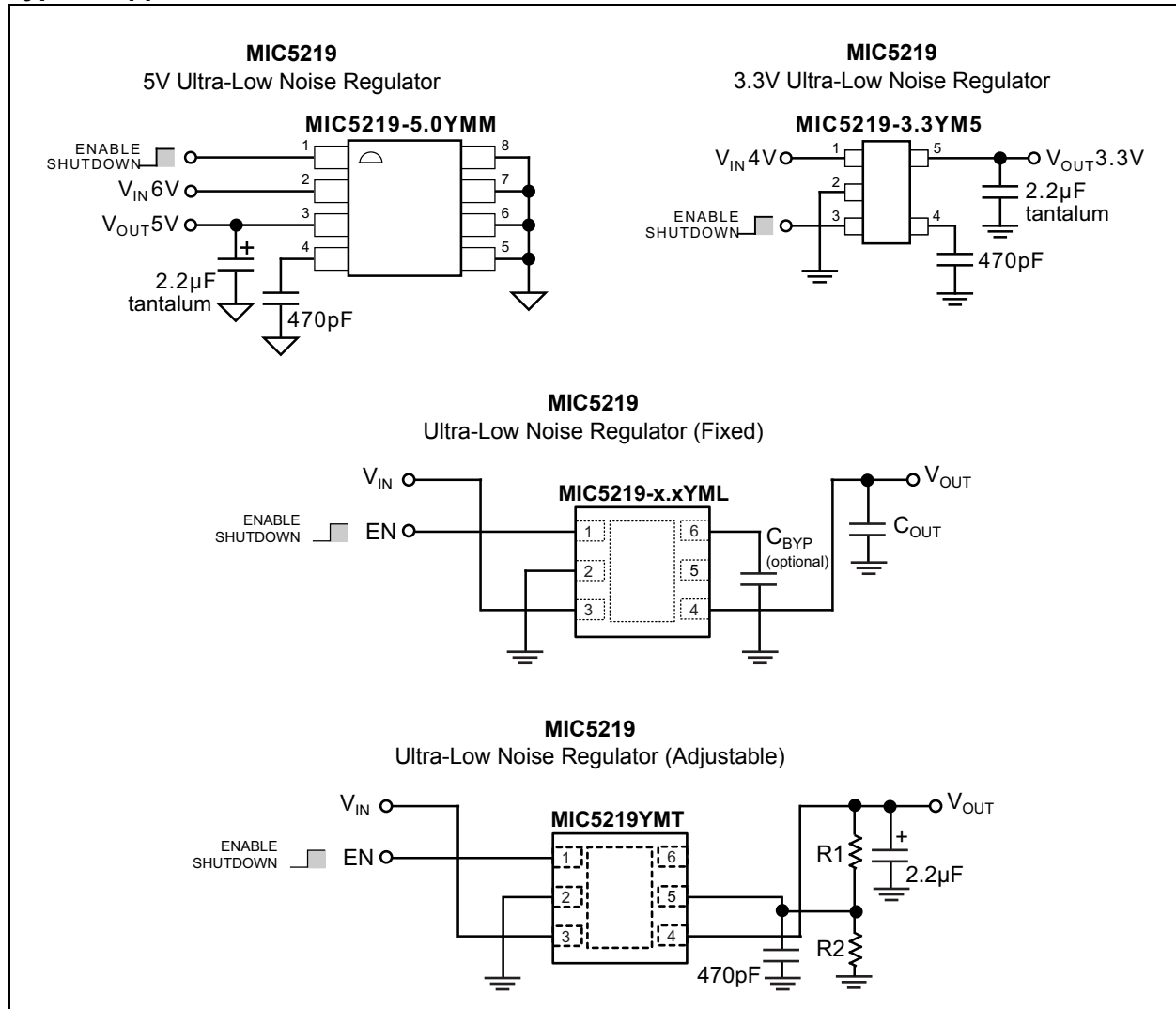

# MIC5219

## Block Diagrams

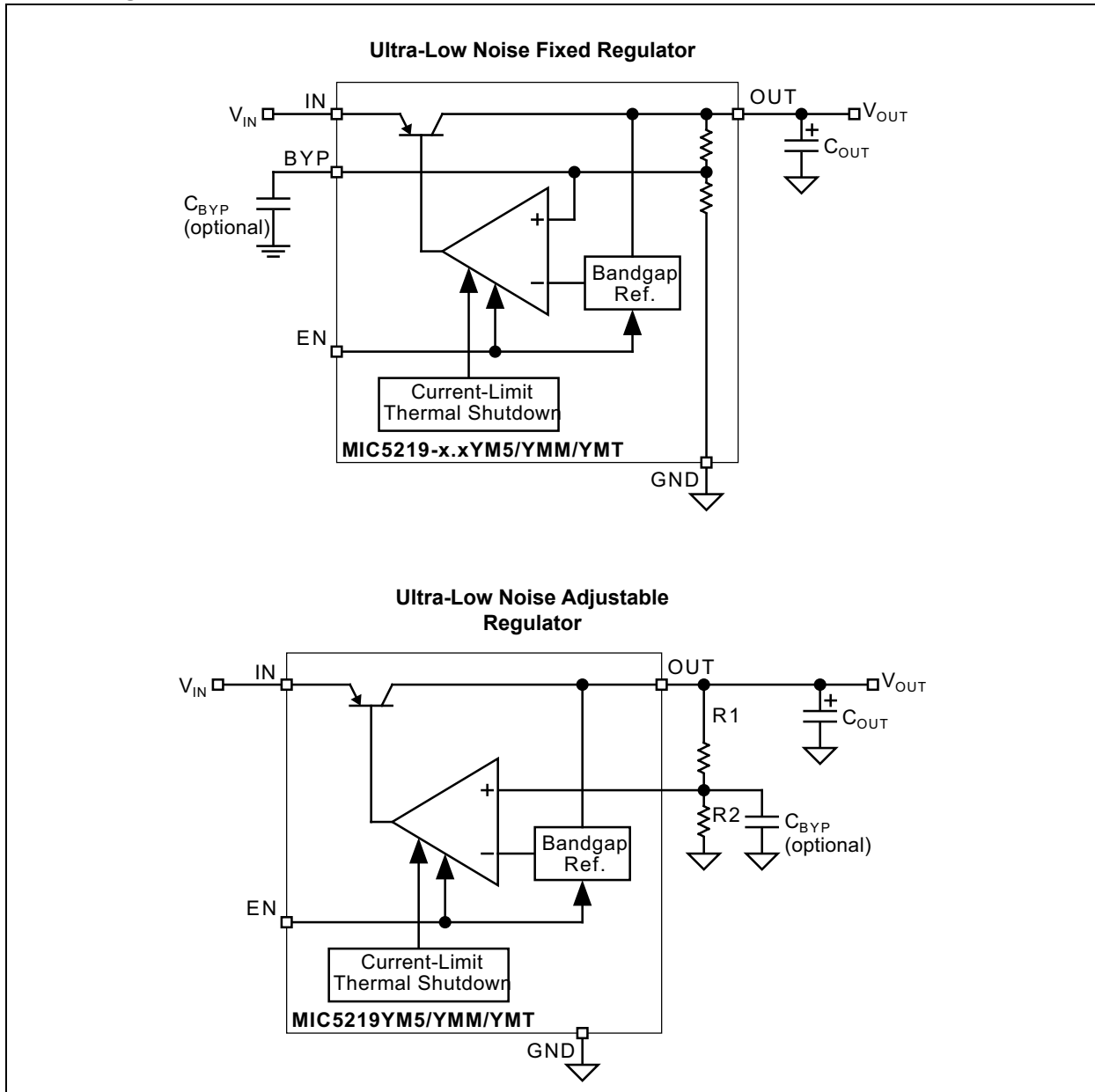

## 1.0 ELECTRICAL CHARACTERISTICS

### Absolute Maximum Ratings †

Supply Input Voltage ( $V_{IN}$ ) ..... -20V to +20V  
 Power Dissipation ( $P_D$ ) ..... Internally Limited

### Operating Ratings ††

Supply Input Voltage ( $V_{IN}$ ) ..... +2.5V to +12V  
 Enable Input Voltage ( $V_{EN}$ ) ..... 0V to  $V_{IN}$

**† Notice:** Absolute maximum ratings indicate limits beyond which damage to the component may occur. Electrical specifications do not apply when operating the device outside of its operating ratings. The maximum allowable power dissipation is a function of the maximum junction temperature,  $T_{J(MAX)}$ , the junction-to-ambient thermal resistance,  $\theta_{JA}$ , and the ambient temperature,  $T_A$ . The maximum allowable power dissipation at any ambient temperature is calculated using:  $P_{D(MAX)} = (T_{J(MAX)} - T_A) \div \theta_{JA}$ . Exceeding the maximum allowable power dissipation will result in excessive die temperature, and the regulator will go into thermal shutdown. See [Table 4-1](#) and the [Thermal Considerations](#) section for details.

**†† Notice:** The device is not guaranteed to function outside its operating rating.

## ELECTRICAL CHARACTERISTICS

**Electrical Characteristics:** Unless otherwise indicated,  $V_{IN} = V_{OUT} + 1.0V$ ;  $C_{OUT} = 4.7 \mu F$ ,  $I_{OUT} = 100 \mu A$ ;  $T_J = +25^\circ C$ , **bold** values indicate  $-40^\circ C \leq T_J \leq +125^\circ C$ .

Parameters	Sym.	Min.	Typ.	Max.	Units	Conditions
Output Voltage	$V_{OUT}$	-1	—	1	%	Variation from Nominal $V_{OUT}$
		<b>-2</b>	—	<b>2</b>	%	
Output Voltage Temperature Coefficient	$\Delta V_{OUT}/\Delta T$	—	<b>40</b>	—	ppm/ $^\circ C$	<a href="#">Note 1</a>
Line Regulation	$\Delta V_{OUT}/V_{OUT}$	—	0.009	0.05	%/V	$V_{IN} = V_{OUT} + 1V$ to 12V
		—	—	<b>0.1</b>		
Load Regulation	$\Delta V_{OUT}/V_{OUT}$	—	0.05	0.5	%	$I_{OUT} = 100 \mu A$ to 500 mA, <a href="#">Note 2</a>
		—	—	<b>0.7</b>		

- Note 1:** Output voltage temperature coefficient is defined as the worst case voltage change divided by the total temperature range.
- 2:** Regulation is measured at constant junction temperature using low duty cycle pulse testing. Parts are tested for load regulation in the load range from 100  $\mu A$  to 500 mA. Changes in output voltage due to heating effects are covered by the thermal regulation specification.
- 3:** Dropout voltage is defined as the input to output differential at which the output voltage drops 2% below its nominal value measured at 1V differential.
- 4:** Ground pin current is the regulator quiescent current plus pass transistor base current. The total current drawn from the supply is the sum of the load current plus the ground pin current.
- 5:**  $V_{EN}$  is the voltage externally applied to devices with the EN (enable) input pin.
- 6:** Thermal regulation is defined as the change in output voltage at a time “t” after a change in power dissipation is applied, excluding load or line regulation effects. Specifications are for a 500 mA load pulse at  $V_{IN} = 12V$  for  $t = 10$  ms.
- 7:**  $C_{BYP}$  is an optional, external bypass capacitor connected to devices with a BYP (bypass) or ADJ (adjust) pin.

# MIC5219

## ELECTRICAL CHARACTERISTICS (CONTINUED)

**Electrical Characteristics:** Unless otherwise indicated,  $V_{IN} = V_{OUT} + 1.0V$ ;  $C_{OUT} = 4.7 \mu F$ ,  $I_{OUT} = 100 \mu A$ ;  $T_J = +25^\circ C$ , **bold values** indicate  $-40^\circ C \leq T_J \leq +125^\circ C$ .

Parameters	Sym.	Min.	Typ.	Max.	Units	Conditions
Dropout Voltage (Note 3)	$V_{IN} - V_{OUT}$	—	10	60	mV	$I_{OUT} = 100 \mu A$
		—	—	<b>80</b>		
		—	115	175	mV	$I_{OUT} = 50 mA$
		—	—	<b>250</b>		
		—	175	300	mV	$I_{OUT} = 150 mA$
		—	—	<b>400</b>		
		—	350	500	mV	$I_{OUT} = 500 mA$
—	—	<b>600</b>				
Ground Pin Current (Note 4, 5)	$I_{GND}$	—	80	130	$\mu A$	$V_{EN} \geq 3.0V$ , $I_{OUT} = 100 \mu A$
		—	—	<b>170</b>		
		—	350	650	$\mu A$	$V_{EN} \geq 3.0V$ , $I_{OUT} = 50 mA$
		—	—	<b>900</b>		
		—	1.8	2.5	mA	$V_{EN} \geq 3.0V$ , $I_{OUT} = 150 mA$
		—	—	<b>3.0</b>		
		—	12	20	mA	$V_{EN} \geq 3.0V$ , $I_{OUT} = 500 mA$
—	—	<b>25</b>				
Ground Pin Quiescent Current (Note 4)		—	0.05	3	$\mu A$	$V_{EN} \leq 0.4V$
		—	0.10	<b>8</b>	$\mu A$	$V_{EN} \leq 0.18V$
Ripple Rejection	PSRR	—	75	—	dB	$f = 120 Hz$
Current Limit	$I_{LIMIT}$	—	700	<b>1000</b>	mA	$V_{OUT} = 0V$
Thermal Regulation (Note 3)	$\Delta V_{OUT}/\Delta P_D$	—	<b>0.05</b>	—	%/W	Note 6
Output Noise (Note 7)	$e_{no}$	—	500	—	nV/ $\sqrt{Hz}$	$I_{OUT} = 50 mA$ , $C_{OUT} = 2.2 \mu F$ , $C_{BYP} = 0$
		—	300	—	nV/ $\sqrt{Hz}$	$I_{OUT} = 50 mA$ , $C_{OUT} = 2.2 \mu F$ , $C_{BYP} = 470 pF$

**Note 1:** Output voltage temperature coefficient is defined as the worst case voltage change divided by the total temperature range.

**2:** Regulation is measured at constant junction temperature using low duty cycle pulse testing. Parts are tested for load regulation in the load range from 100  $\mu A$  to 500 mA. Changes in output voltage due to heating effects are covered by the thermal regulation specification.

**3:** Dropout voltage is defined as the input to output differential at which the output voltage drops 2% below its nominal value measured at 1V differential.

**4:** Ground pin current is the regulator quiescent current plus pass transistor base current. The total current drawn from the supply is the sum of the load current plus the ground pin current.

**5:**  $V_{EN}$  is the voltage externally applied to devices with the EN (enable) input pin.

**6:** Thermal regulation is defined as the change in output voltage at a time "t" after a change in power dissipation is applied, excluding load or line regulation effects. Specifications are for a 500 mA load pulse at  $V_{IN} = 12V$  for  $t = 10 ms$ .

**7:**  $C_{BYP}$  is an optional, external bypass capacitor connected to devices with a BYP (bypass) or ADJ (adjust) pin.

## ELECTRICAL CHARACTERISTICS (CONTINUED)

**Electrical Characteristics:** Unless otherwise indicated,  $V_{IN} = V_{OUT} + 1.0V$ ;  $C_{OUT} = 4.7 \mu F$ ,  $I_{OUT} = 100 \mu A$ ;  $T_J = +25^\circ C$ , **bold** values indicate  $-40^\circ C \leq T_J \leq +125^\circ C$ .

Parameters	Sym.	Min.	Typ.	Max.	Units	Conditions
<b>ENABLE Input</b>						
Enable Input Logic-Low Voltage	$V_{ENL}$	—	—	0.4	V	$V_{EN} = \text{logic low (regulator shutdown)}$
		—	—	<b>0.18</b>		
		2.0	—	—	V	$V_{EN} = \text{logic high (regulator enabled)}$
Enable Input Current	$I_{ENL}$	—	0.01	-1	$\mu A$	$V_{ENL} \leq 0.4V$
		—	<b>0.01</b>	<b>-2</b>		$V_{ENL} \leq 0.18V$
	$I_{ENH}$	2	5	20	$\mu A$	$V_{ENH} \geq 2.0V$
		—	—	<b>25</b>		

- Note 1:** Output voltage temperature coefficient is defined as the worst case voltage change divided by the total temperature range.
- 2:** Regulation is measured at constant junction temperature using low duty cycle pulse testing. Parts are tested for load regulation in the load range from 100  $\mu A$  to 500 mA. Changes in output voltage due to heating effects are covered by the thermal regulation specification.
- 3:** Dropout voltage is defined as the input to output differential at which the output voltage drops 2% below its nominal value measured at 1V differential.
- 4:** Ground pin current is the regulator quiescent current plus pass transistor base current. The total current drawn from the supply is the sum of the load current plus the ground pin current.
- 5:**  $V_{EN}$  is the voltage externally applied to devices with the EN (enable) input pin.
- 6:** Thermal regulation is defined as the change in output voltage at a time "t" after a change in power dissipation is applied, excluding load or line regulation effects. Specifications are for a 500 mA load pulse at  $V_{IN} = 12V$  for  $t = 10 \text{ ms}$ .
- 7:**  $C_{BYP}$  is an optional, external bypass capacitor connected to devices with a BYP (bypass) or ADJ (adjust) pin.

# MIC5219

## TEMPERATURE SPECIFICATIONS (Note 1)

Parameters	Sym.	Min.	Typ.	Max.	Units	Conditions
<b>Temperature Ranges</b>						
Operating Ambient Temperature Range	$T_A$	-40	—	+125	°C	—
Maximum Junction Temperature Range	$T_J$	-40	—	+125	°C	—
Storage Temperature Range	$T_S$	-65	—	+150	°C	—
Lead Temperature	—	—	260	—	°C	Soldering, 5 sec.
<b>Package Thermal Resistances</b>						
Thermal Resistance, MSOP-8Ld	$\theta_{JA}$	—	160	—	°C/W	Minimum footprint area.
Thermal Resistance, SOT23-5Ld	$\theta_{JA}$	—	220	—	°C/W	Minimum footprint area.
Thermal Resistance, VDFN-6Ld	$\theta_{JA}$	—	90	—	°C/W	Minimum footprint area.
Thermal Resistance, TDFN-6Ld	$\theta_{JA}$	—	90	—	°C/W	Minimum footprint area.

**Note 1:** The maximum allowable power dissipation is a function of ambient temperature, the maximum allowable junction temperature and the thermal resistance from junction to air (i.e.,  $T_A$ ,  $T_J$ ,  $\theta_{JA}$ ). Exceeding the maximum allowable power dissipation will cause the device operating junction temperature to exceed the maximum +125°C rating. Sustained junction temperatures above +125°C can impact the device reliability.



## 2.0 TYPICAL PERFORMANCE CURVES

**Note:** The graphs and tables provided following this note are a statistical summary based on a limited number of samples and are provided for informational purposes only. The performance characteristics listed herein are not tested or guaranteed. In some graphs or tables, the data presented may be outside the specified operating range (e.g., outside specified power supply range) and therefore outside the warranted range.

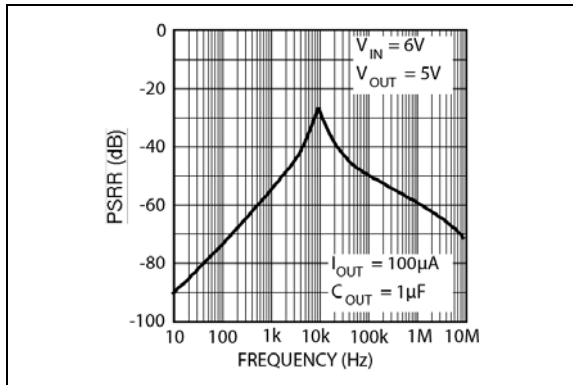

**FIGURE 2-1:** Power Supply Rejection Ratio.

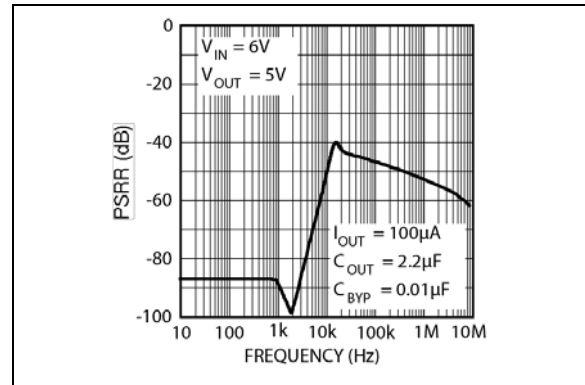

**FIGURE 2-4:** Power Supply Rejection Ratio.

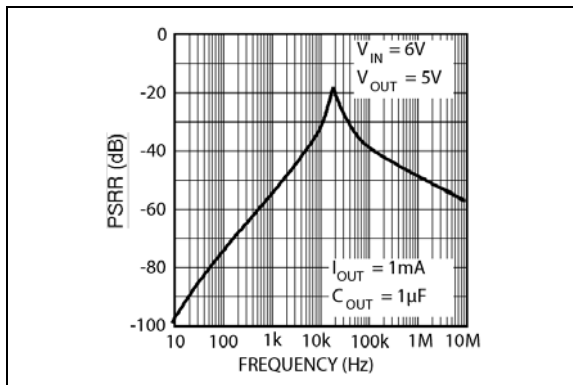

**FIGURE 2-2:** Power Supply Rejection Ratio.

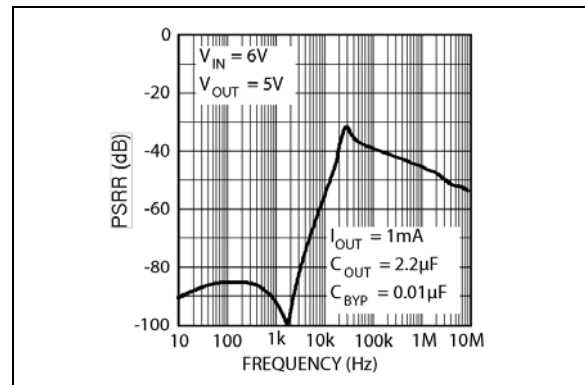

**FIGURE 2-5:** Power Supply Rejection Ratio.

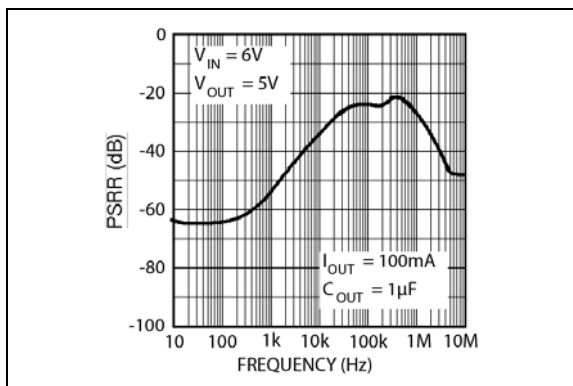

**FIGURE 2-3:** Power Supply Rejection Ratio.

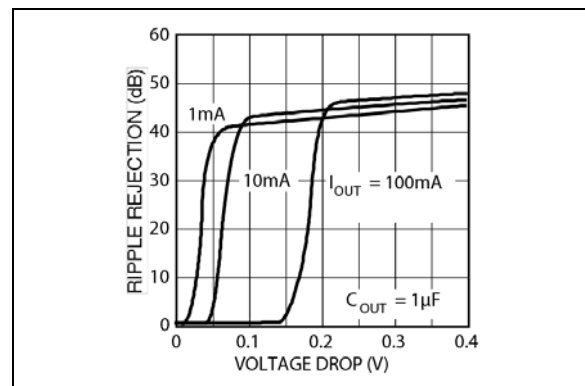

**FIGURE 2-6:** Power Supply Ripple Rejection vs. Voltage Drop.

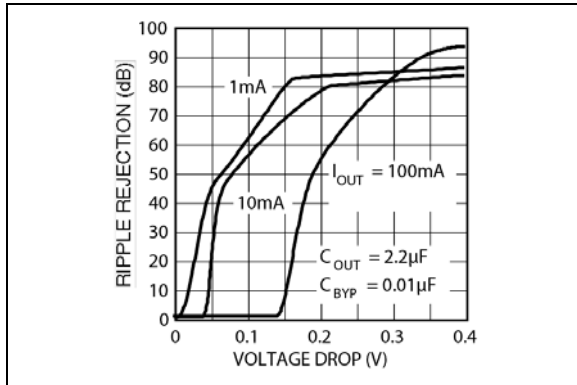

**FIGURE 2-7:** Power Supply Ripple Rejection vs. Voltage Drop.

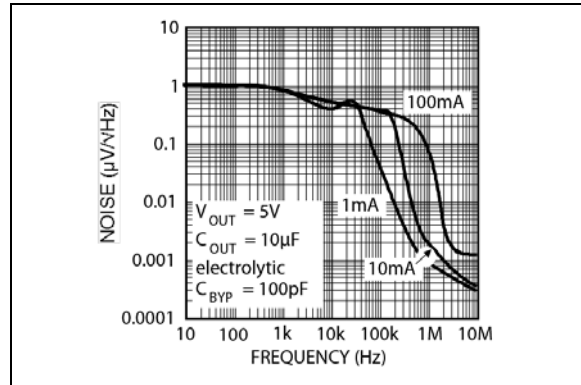

**FIGURE 2-10:** Noise Performance.

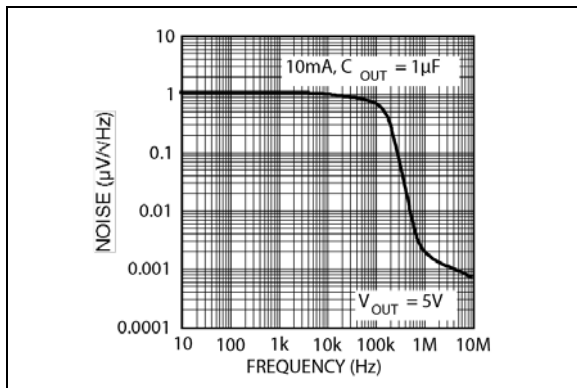

**FIGURE 2-8:** Noise Performance.

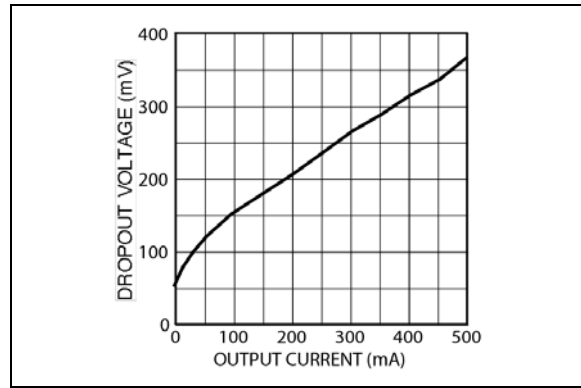

**FIGURE 2-11:** Dropout Voltage vs. Output Current.

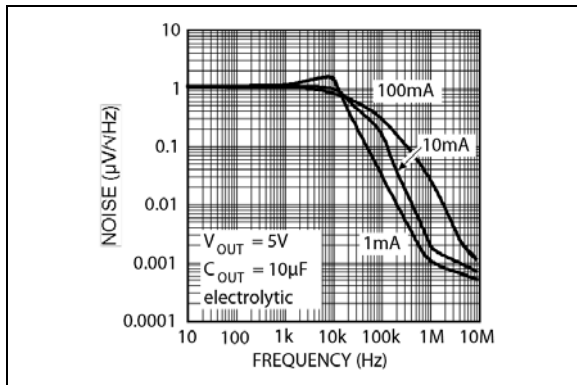

**FIGURE 2-9:** Noise Performance.

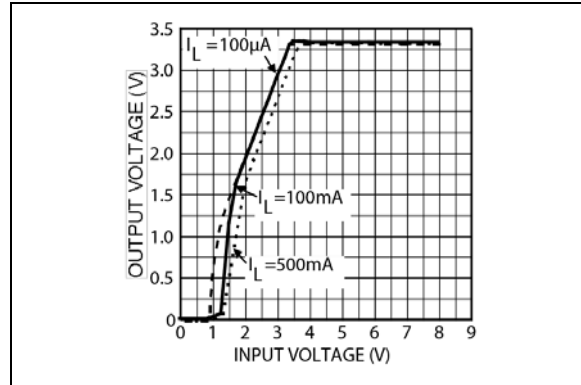

**FIGURE 2-12:** Dropout Characteristics.

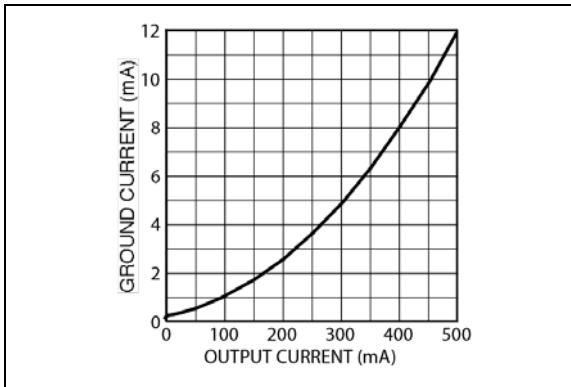

**FIGURE 2-13:** Ground Current vs. Output Current.

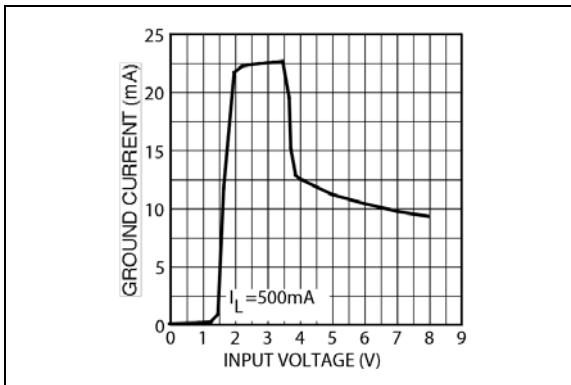

**FIGURE 2-14:** Ground Current vs. Supply Voltage.

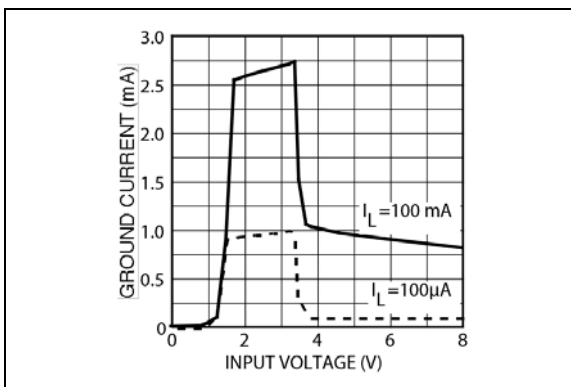

**FIGURE 2-15:** Ground Current vs. Supply Voltage.

# MIC5219

---

## 3.0 PIN DESCRIPTIONS

The descriptions of the pins are listed in [Table 3-1](#).

**TABLE 3-1: PIN FUNCTION TABLE**

Pin Number VDFN-6 TDFN-6	Pin Number MSOP-8	Pin Number SOT23-5	Pin Name	Description
3	2	1	IN	Supply input.
2	5 - 8	2	GND	Ground: MSOP-8 pins 5 through 8 are internally connected.
4	3	5	OUT	Regulator output.
1	1	3	EN	Enable (input): CMOS-compatible control input. Logic-high = enable; logic-low or open = shutdown.
6	4 (FIXED)	4 (FIXED)	BYP	Reference bypass: Connect an external 470 pF capacitor to GND to reduce output noise. May be left open.
5 (NC)	4 (ADJ)	4 (ADJ)	ADJ	Adjust (input): Feedback input. Connect to resistive voltage-divider network.
EP	—	—	GND	Ground: Internally connected to the exposed pad. Connect externally to GND pin.

## 4.0 APPLICATION INFORMATION

The MIC5219 is designed for 150 mA to 200 mA output current applications where a high-current spike (500 mA) is needed for short, start-up conditions. Basic application of the device will be discussed initially followed by a more detailed discussion of higher current applications.

### 4.1 Enable/Shutdown

Forcing EN (enable/shutdown) high (>2V) enables the regulator. EN is compatible with CMOS logic. If the enable/shutdown feature is not required, connect EN to IN (supply input). See [Figure 4-5](#).

### 4.2 Input Capacitor

A 1  $\mu$ F capacitor should be placed from IN to GND if there is more than 10 inches of wire between the input and the AC filter capacitor or if a battery is used as the input.

### 4.3 Output Capacitor

An output capacitor is required between OUT and GND to prevent oscillation. The minimum size of the output capacitor is dependent upon whether a reference bypass capacitor is used. 1  $\mu$ F minimum is recommended when  $C_{BYP}$  is not used (see [Figure 4-5](#)). 2.2  $\mu$ F minimum is recommended when  $C_{BYP}$  is 470 pF (see [Figure 4-6](#)). For applications <3V, the output capacitor should be increased to 22  $\mu$ F minimum to reduce start-up overshoot. Larger values improve the regulator's transient response. The output capacitor value may be increased without limit.

The output capacitor should have an ESR (equivalent series resistance) of about 1 $\Omega$  or less and a resonant frequency above 1 MHz. Ultra-low ESR capacitors could cause oscillation and/or under-damped transient response. Most tantalum or aluminum electrolytic capacitors are adequate; film types will work, but are more expensive. Many aluminum electrolytics have electrolytes that freeze at about  $-30^{\circ}\text{C}$ , so solid tantalums are recommended for operation below  $-25^{\circ}\text{C}$ .

At lower values of output current, less output capacitance is needed for stability. The capacitor can be reduced to 0.47  $\mu$ F for current below 10 mA, or 0.33  $\mu$ F for currents below 1 mA.

### 4.4 No-Load Stability

The MIC5219 will remain stable and in regulation with no load (other than the internal voltage divider) unlike many other voltage regulators. This is especially important in CMOS RAM keep-alive applications.

### 4.5 Reference Bypass Capacitor

BYP is connected to the internal voltage reference. A 470 pF capacitor ( $C_{BYP}$ ) connected from BYP to GND quiets this reference, providing a significant reduction in output noise (ultra-low noise performance).  $C_{BYP}$  reduces the regulator phase margin; when using  $C_{BYP}$ , output capacitors of 2.2  $\mu$ F or greater are generally required to maintain stability.

The start-up speed of the MIC5219 is inversely proportional to the size of the reference bypass capacitor. Applications requiring a slow ramp-up of output voltage should consider larger values of  $C_{BYP}$ . Likewise, if rapid turn-on is necessary, consider omitting  $C_{BYP}$ .

### 4.6 Thermal Considerations

The MIC5219 is designed to provide 200 mA of continuous current in two very small profile packages. Maximum power dissipation can be calculated based on the output current and the voltage drop across the part. To determine the maximum power dissipation of the package, use the thermal resistance, junction-to-ambient, of the device and the following basic equation.

#### EQUATION 4-1:

$$P_{D(MAX)} = \frac{T_{J(MAX)} - T_A}{\theta_{JA}}$$

$T_{J(MAX)}$  is the maximum junction temperature of the die,  $+125^{\circ}\text{C}$ , and  $T_A$  is the ambient operating temperature.  $\theta_{JA}$  is layout-dependent; [Table 4-1](#) shows examples of thermal resistance, junction-to-ambient, for the MIC5219.

**TABLE 4-1: MIC5219 THERMAL RESISTANCE**

Package	$\theta_{JA}$ Rec. Min. Footprint	$\theta_{JA}$ 1" Square 2 oz. Copper	$\theta_{JC}$
MSOP-8	160 $^{\circ}\text{C}/\text{W}$	70 $^{\circ}\text{C}/\text{W}$	30 $^{\circ}\text{C}/\text{W}$
SOT23-5	220 $^{\circ}\text{C}/\text{W}$	170 $^{\circ}\text{C}/\text{W}$	130 $^{\circ}\text{C}/\text{W}$
2x2 VDFN	90 $^{\circ}\text{C}/\text{W}$	—	—
2x2TDFN	90 $^{\circ}\text{C}/\text{W}$	—	—

# MIC5219

The actual power dissipation of the regulator circuit can be determined using one simple equation.

## EQUATION 4-2:

$$P_D = (V_{IN} - V_{OUT}) \times I_{OUT} + V_{IN} \times I_{GND}$$

Substituting  $P_{D(MAX)}$  for  $P_D$  and solving for the operating conditions that are critical to the application will give the maximum operating conditions for the regulator circuit. For example, if we are operating the MIC5219-3.3YM5 at room temperature, with a minimum footprint layout, we can determine the maximum input voltage for a set output current.

## EQUATION 4-3:

$$P_{D(MAX)} = \frac{125^{\circ}C - 25^{\circ}C}{220^{\circ}C/W} = 455mW$$

The thermal resistance, junction-to-ambient, for the minimum footprint is  $220^{\circ}C/W$ , taken from [Table 4-1](#). The maximum power dissipation number cannot be exceeded for proper operation of the device. Using the output voltage of 3.3V, and an output current of 150 mA, we can determine the maximum input voltage. Ground current, maximum of 3 mA for 150 mA of output current, can be taken from the [Electrical Characteristics](#) section of the data sheet.

## EQUATION 4-4:

$$455mW = (V_{IN} - 3.3V) \times 150mA + V_{IN} \times 3mA$$

$$455mW = 150mA \times V_{IN} + 3mA \times V_{IN} - 495mW$$

$$950mW = 153mA \times V_{IN}$$

$$V_{IN(MAX)} = 6.2V_{MAX}$$

Therefore, a 3.3V application at 150 mA of output current can accept a maximum input voltage of 6.2V in a SOT23-5 package. For a full discussion of heat sinking and thermal effects on voltage regulators, refer to the "Regulator Thermals" section of Microchip's [Designing with Low-Dropout Voltage Regulators](#) handbook.

## 4.7 Peak Current Applications

The MIC5219 is designed for applications where high start-up currents are demanded from space constrained regulators. This device will deliver 500 mA start-up current from a SOT23-5 or MSOP-8 package, allowing high power from a very low profile device. The MIC5219 can subsequently provide output current that is only limited by the thermal characteristics of the device. You can obtain higher continuous currents from the device with the proper design. This is easily proved with some thermal calculations.

If we look at a specific example, it may be easier to follow. The MIC5219 can be used to provide up to 500 mA continuous output current. First, calculate the maximum power dissipation of the device, as was done in the [Thermal Considerations](#) section. Worst case thermal resistance ( $\theta_{JA} = 220^{\circ}C/W$  for the MIC5219-x.xYM5), will be used for this example.

## EQUATION 4-5:

$$P_{D(MAX)} = \frac{T_{J(MAX)} - T_A}{\theta_{JA}}$$

Assuming a  $25^{\circ}C$  room temperature, we have a maximum power dissipation value calculated in [Equation 4-6](#).

## EQUATION 4-6:

$$P_{D(MAX)} = \frac{125^{\circ}C - 25^{\circ}C}{220^{\circ}C/W} = 455mW$$

Then we can determine the maximum input voltage for a 5 volt regulator operating at 500 mA, using worst case ground current.

## EQUATION 4-7:

$$P_{D(MAX)} = 455mW = (V_{IN} - V_{OUT}) \times I_{OUT} + V_{IN} \times I_{GND}$$

Where:

$$I_{OUT} = 500 \text{ mA}$$

$$V_{OUT} = 5V$$

$$I_{GND} = 20 \text{ mA}$$

$$455mW = (V_{IN} - 5V) \times 500mA + V_{IN} \times 20mA$$

$$2.995W = 520mA \times V_{IN}$$

$$V_{IN(MAX)} = \frac{2.995W}{520mA} = 5.683V$$

Therefore, to be able to obtain a constant 500 mA output current from the MIC5219-5.0YM5 at room temperature, you need extremely tight input-output voltage differential, barely above the maximum dropout voltage for that current rating.

You can run the part from larger supply voltages if the proper precautions are taken. Varying the duty cycle using the enable pin can increase the power dissipation of the device by maintaining a lower average power figure. This is ideal for applications where high current is only needed in short bursts. [Figure 4-1](#) shows the safe operating regions for the MIC5219-x.xYM5 at three different ambient temperatures and at different output currents. The data used to determine this figure assumed a minimum footprint PCB design for minimum heat sinking. [Figure 4-2](#) incorporates the same factors as the first figure, but assumes a much better heat sink. A 1" square copper trace on the PC board reduces the thermal resistance of the device. This improved thermal resistance improves power dissipation and allows for a larger safe operating region.

[Figure 4-3](#) and [Figure 4-4](#) show safe operating regions for the MIC5219-x.xYMM, the power MSOP package part. These graphs show three typical operating regions at different temperatures. The lower the temperature, the larger the operating region. The graphs were obtained in a similar way to the graphs for the MIC5219-x.xYM5, taking all factors into consideration and using two different board layouts, minimum footprint and 1" square copper PC board heat sink. For further discussion of PC board heat sink characteristics, refer to [Application Hint 17, Designing PC Board Heat Sinks](#).

The information used to determine the safe operating regions can be obtained in a similar manner such as determining typical power dissipation, already discussed. Determining the maximum power dissipation based on the layout is the first step, this is

done in the same manner as in the previous two sections. Then, a larger power dissipation number multiplied by a set maximum duty cycle would give that maximum power dissipation number for the layout. This is best shown through an example. If the application calls for 5V at 500 mA for short pulses, but the only supply voltage available is 8V, then the duty cycle has to be adjusted to determine an average power that does not exceed the maximum power dissipation for the layout.

## EQUATION 4-8:

$$Avg P_D = \left(\frac{\%DC}{100}\right)(V_{IN} - V_{OUT}) \times I_{OUT} + V_{IN} \times I_{GND}$$

$$455mW = \left(\frac{\%DC}{100}\right)(8V - 5V) \times 500mA + 8V \times 20mA$$

$$455mW = \left(\frac{\%DC}{100}\right) \times 1.66W$$

$$0.274 = \frac{\%DC}{100}$$

$$\%DC = 27.4\% \text{ (Duty Cycle Max.)}$$

With an output current of 500 mA and a three volt drop across the MIC5219-xxYMM, the maximum duty cycle is 27.4%.

Applications also call for a set nominal current output with a greater amount of current needed for short durations. This is a tricky situation, but it is easily remedied. Calculate the average power dissipation for each current section, then add the two numbers giving the total power dissipation for the regulator. For example, if the regulator is operating normally at 50 mA, but for 12.5% of the time it operates at 500 mA output, the total power dissipation of the part can be easily determined. First, calculate the power dissipation of the device at 50 mA. We will use the MIC5219-3.3YM5 with 5V input voltage as our example.

## EQUATION 4-9:

$$P_D \times 50mA = (5V - 3.3V) \times 50mA + 5V \times 650\mu A$$

$$P_D \times 50mA = 88.25mW$$

# MIC5219

However, this is continuous power dissipation, the actual on-time for the device at 50 mA is (100% – 12.5%) or 87.5% of the time, or 87.5% duty cycle. Therefore,  $P_D$  must be multiplied by the duty cycle to obtain the actual average power dissipation at 50 mA.

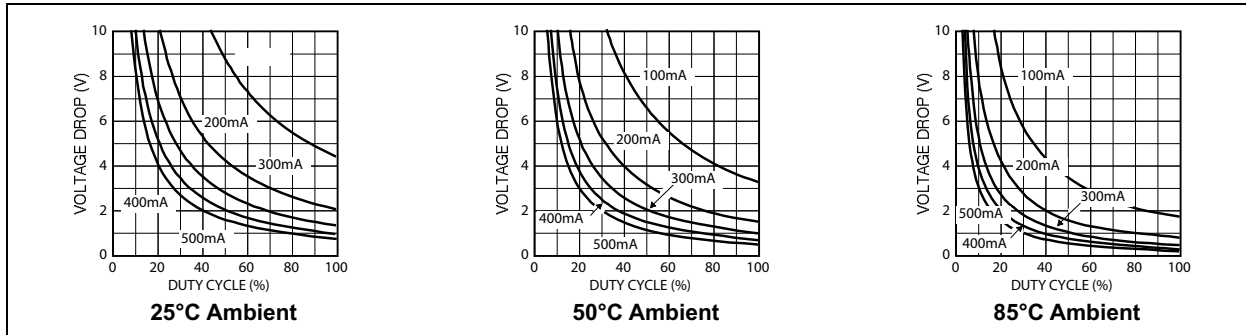

**FIGURE 4-1:** MIC5219-x.xYM5 (SOT23-5) on Minimum Recommended Footprint.

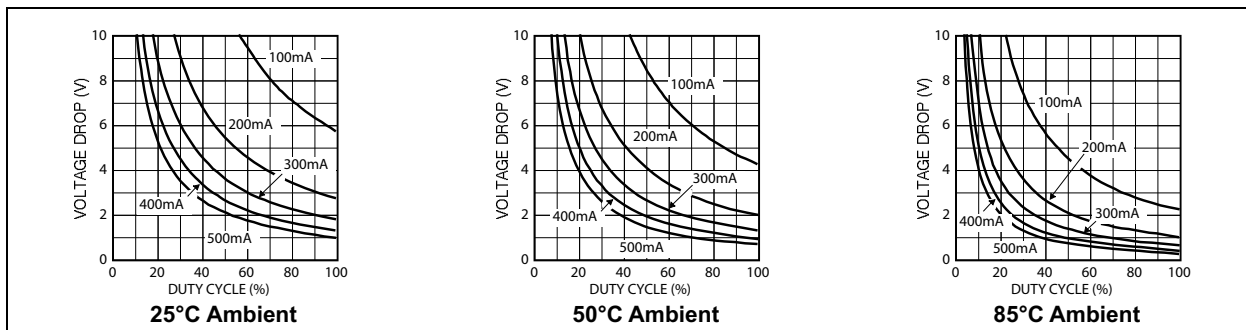

**FIGURE 4-2:** MIC5219-x.xYM5 (SOT23-5) on 1-Inch<sup>2</sup> Copper Cladding.

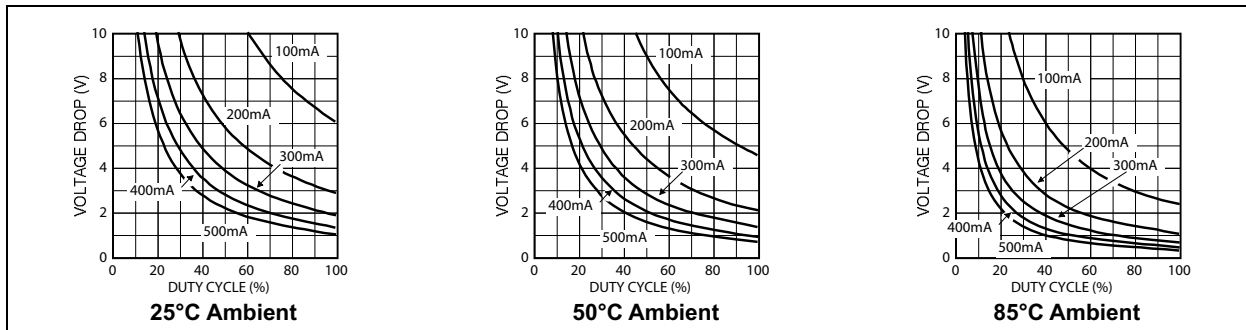

**FIGURE 4-3:** MIC5219-x.xYMM (MSOP-8) on Minimum Recommended Footprint.

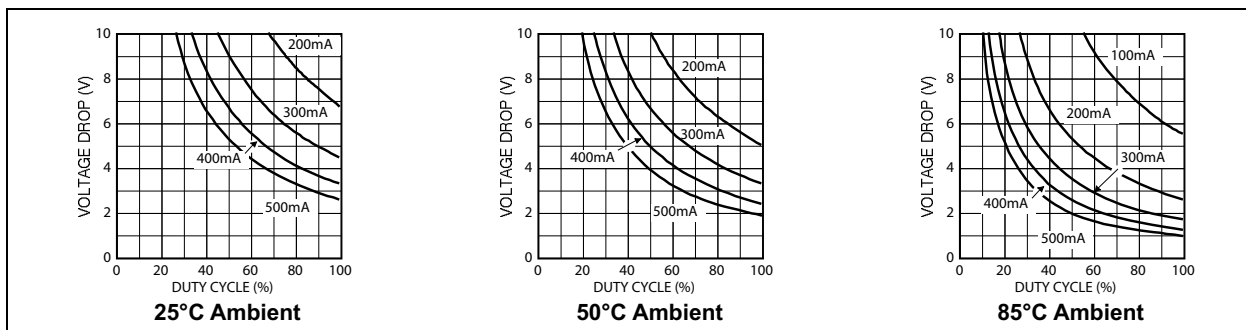

**FIGURE 4-4:** MIC5219-x.xYMM (MSOP-8) on 1-Inch<sup>2</sup> Copper Cladding.



## EQUATION 4-10:

$$P_D \times 50mA = 0.875 \times 88.25mW$$

$$P_D \times 50mA = 77.22mW$$

The power dissipation at 500 mA must also be calculated.

## EQUATION 4-11:

$$P_D \times 500mA = (5V - 3.3V) \times 500mA + 5V \times 20mA$$

$$P_D \times 500mA = 950mW$$

This number must be multiplied by the duty cycle at which it would be operating: 12.5%.

## EQUATION 4-12:

$$P_D = 0.125 \times 950mW$$

$$P_D = 118.75mW$$

The total power dissipation of the device under these conditions is the sum of the two power dissipation figures.

## EQUATION 4-13:

$$P_{D(TOTAL)} = P_D \times 50mA + P_D \times 500mA$$

$$P_{D(TOTAL)} = 77.22mW + 118.75mW$$

$$P_{D(TOTAL)} = 196mW$$

The total power dissipation of the regulator is less than the maximum power dissipation of the SOT23-5 package at room temperature, on a minimum footprint board and therefore would operate properly.

Multilayer boards with a ground plane, wide traces near the pads, and large supply-bus lines will have better thermal conductivity.

For additional heat sink characteristics, please refer to [Application Hint 17, Designing P.C. Board Heat Sinks](#). For a full discussion of heat sinking and thermal effects on voltage regulators, refer to "Regulator Thermals" section of Microchip's [Designing with Low-Dropout Voltage Regulators handbook](#).

## 4.8 Fixed Regulator Circuits

Figure 4-5 shows a basic MIC5219-x.xYMX fixed-voltage regulator circuit. A 1µF minimum output capacitor is required for basic fixed-voltage applications.

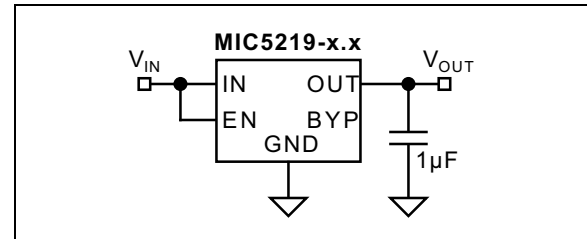

**FIGURE 4-5:** Low-Noise Fixed Voltage Regulator.

Figure 4-6 includes the optional 470 pF noise bypass capacitor between BYP and GND to reduce output noise. Note that the minimum value of C<sub>OUT</sub> must be increased when the bypass capacitor is used.

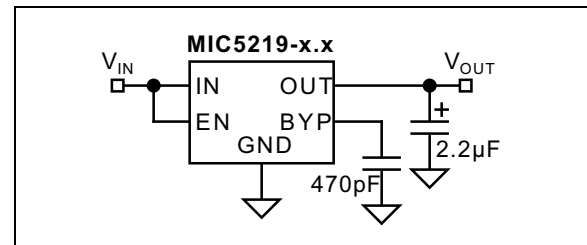

**FIGURE 4-6:** Ultra-Low Noise Fixed Voltage Regulator.

## 4.9 Adjustable Regulator Circuits

Figure 4-7 shows the basic circuit for the MIC5219 adjustable regulator. The output voltage is configured by selecting values for R1 and R2 using the following formula.

## EQUATION 4-14:

$$V_{OUT} = 1.242V \times \left( \frac{R2}{R1} + 1 \right)$$

This equation is correct due to the configuration of the bandgap reference. The bandgap voltage is relative to the output, as seen in the block diagram. Traditional regulators normally have the reference voltage relative to ground and have a different V<sub>OUT</sub> equation.

# MIC5219

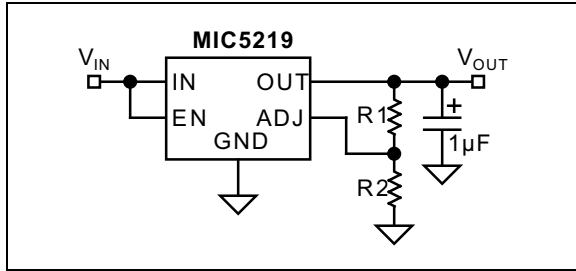

**FIGURE 4-7:** *Low-Noise Adjustable Voltage Regulator.*

Although ADJ is a high-impedance input, for best performance, R2 should not exceed 470 k $\Omega$ .

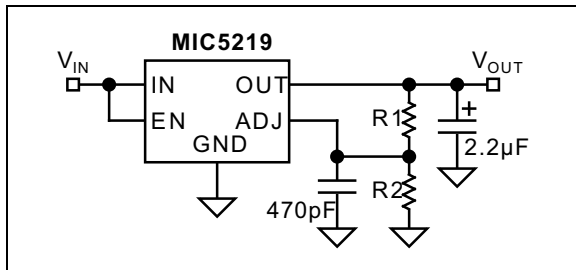

**FIGURE 4-8:** *Ultra-Low Noise Adjustable Application.*

Figure 4-8 includes the optional 470 pF bypass capacitor from ADJ to GND to reduce output noise.

## 5.0 PACKAGING INFORMATION

### 5.1 Package Marking Information

5-Lead SOT23\*

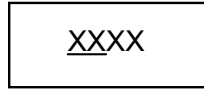

Example

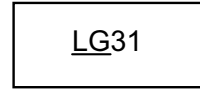

6-Lead VDFN\*

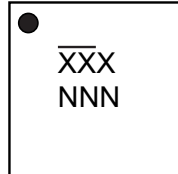

Example

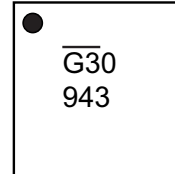

6-Lead TDFN\*

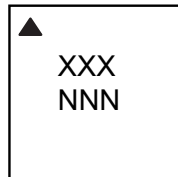

Example

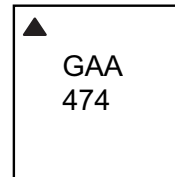

8-Lead MSOP\*

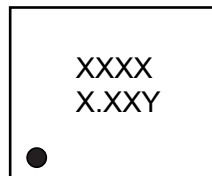

Example

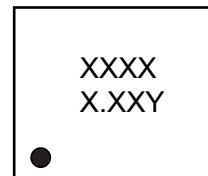

<b>Legend:</b>	XX...X	Product code or customer-specific information
	Y	Year code (last digit of calendar year)
	YY	Year code (last 2 digits of calendar year)
	WW	Week code (week of January 1 is week '01')
	NNN	Alphanumeric traceability code
	(e3)	Pb-free JEDEC® designator for Matte Tin (Sn)
	*	This package is Pb-free. The Pb-free JEDEC designator (e3) can be found on the outer packaging for this package.
	•, ▲, ▼	Pin one index is identified by a dot, delta up, or delta down (triangle mark).
<b>Note:</b>	In the event the full Microchip part number cannot be marked on one line, it will be carried over to the next line, thus limiting the number of available characters for customer-specific information. Package may or may not include the corporate logo.	
	Underbar (̄) and/or Overbar (¯) symbol may not be to scale.	

# MIC5219

## 5-Lead SOT23 Package Outline and Recommended Land Pattern

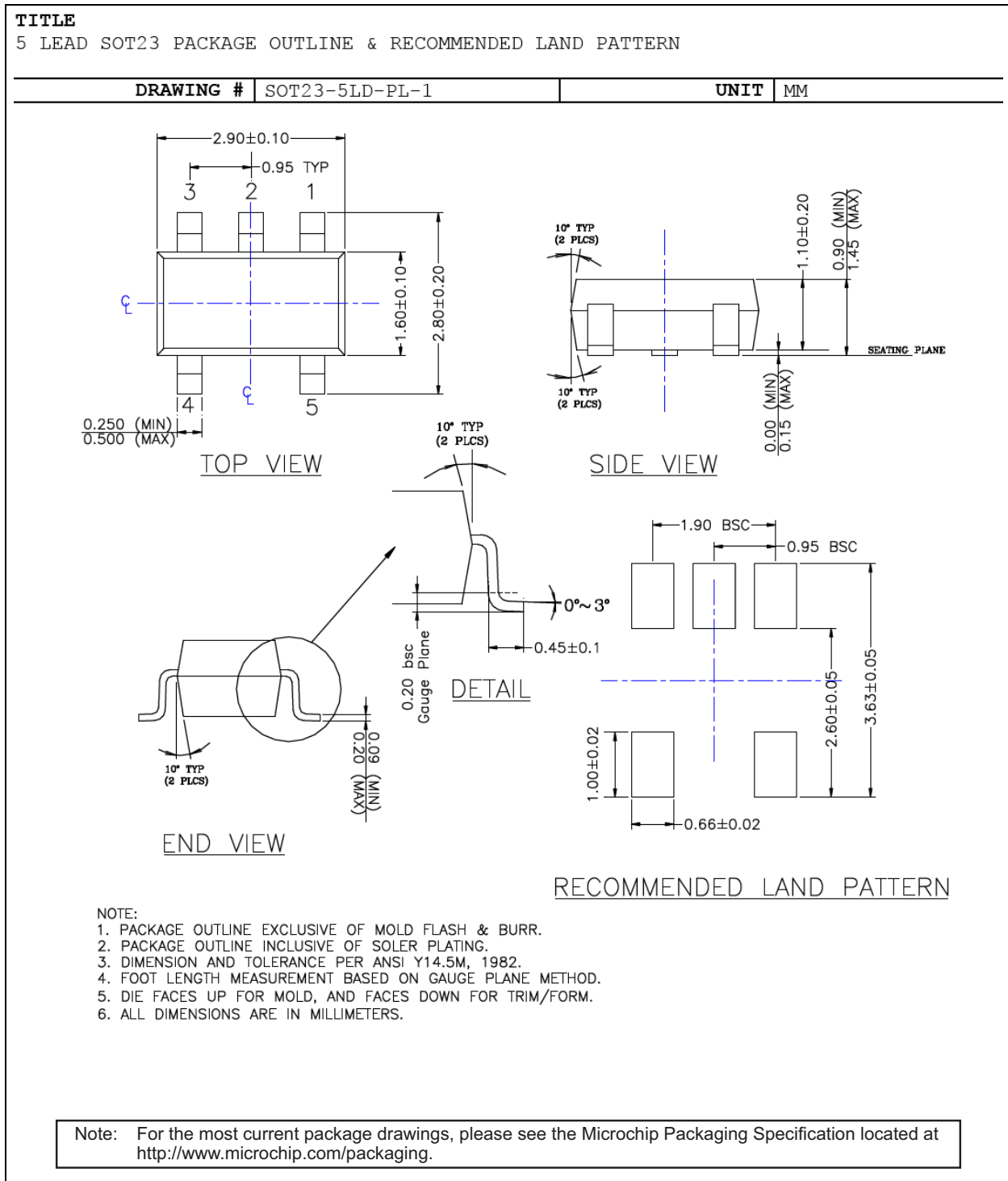

## 6-Lead VDFN 2 mm x 2 mm Package Outline and Recommended Land Pattern

### 6-Lead Very Thin Plastic Dual Flat, No Lead Package (JDA) - 2x2 mm Body [VDFN] Micrel Legacy Package

**Note:** For the most current package drawings, please see the Microchip Packaging Specification located at <http://www.microchip.com/packaging>

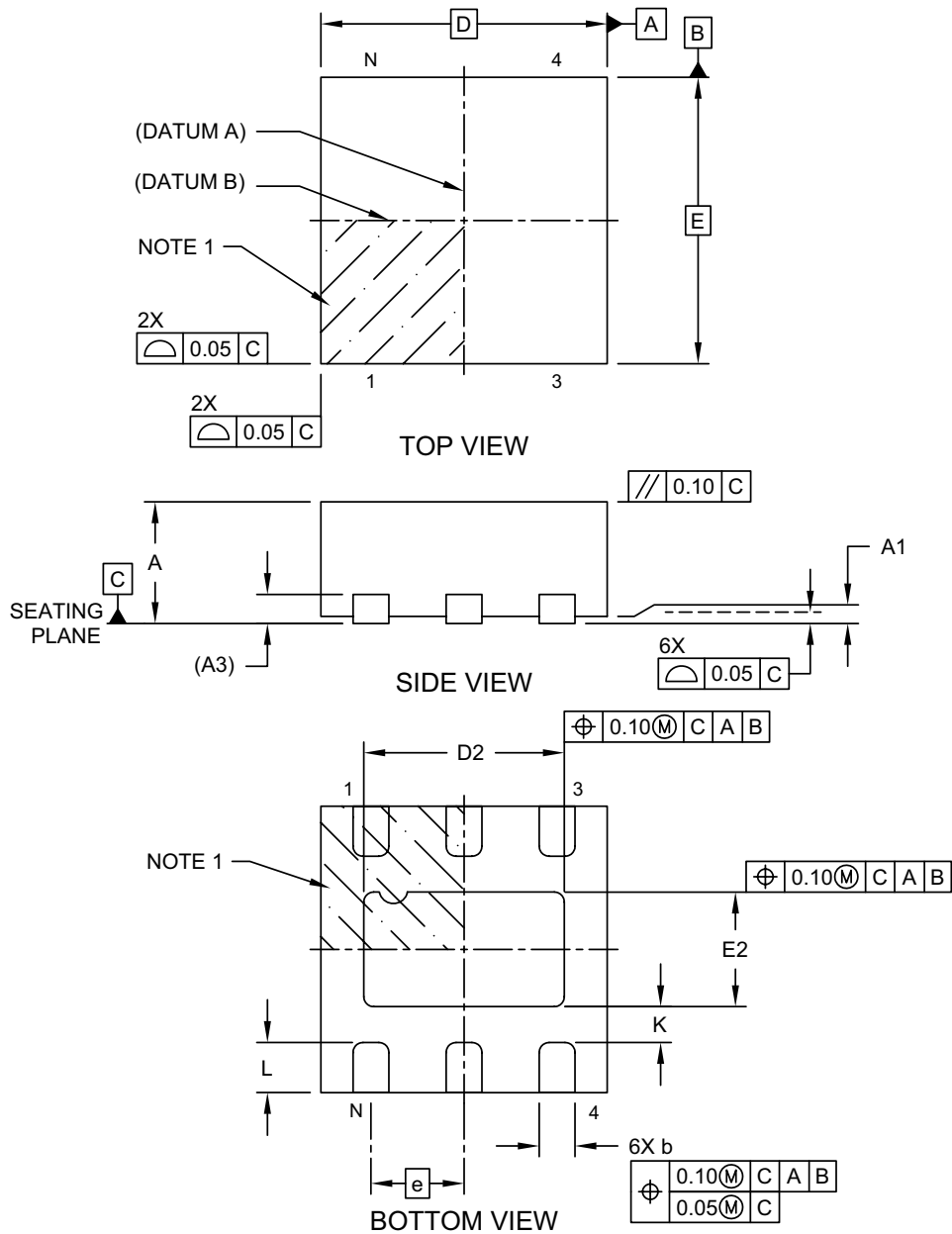

Microchip Technology Drawing C04-1016A Sheet 1 of 2

# MIC5219

## 6-Lead Very Thin Plastic Dual Flat, No Lead Package (JDA) - 2x2 mm Body [VDFN] Micrel Legacy Package

**Note:** For the most current package drawings, please see the Microchip Packaging Specification located at <http://www.microchip.com/packaging>

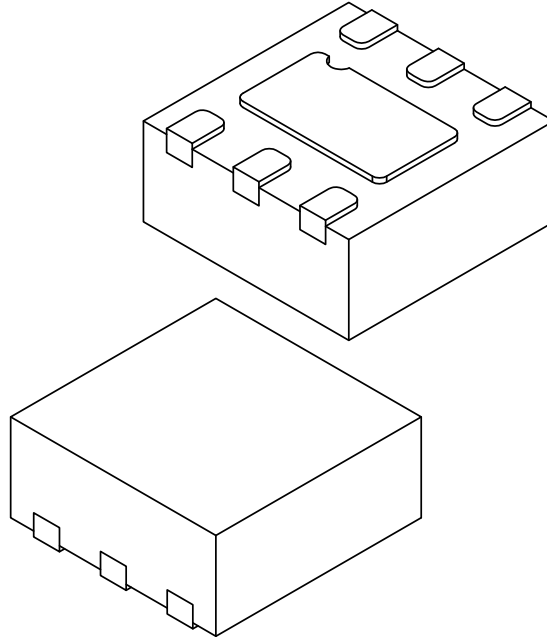

Dimension Limits	Units	MILLIMETERS		
		MIN	NOM	MAX
Number of Terminals	N	6		
Pitch	e	0.65 BSC		
Overall Height	A	0.80	0.85	0.90
Standoff	A1	0.00	0.02	0.05
Terminal Thickness	A3	0.203 REF		
Overall Length	D	2.00 BSC		
Exposed Pad Length	D2	1.35	1.40	1.45
Overall Width	E	2.00 BSC		
Exposed Pad Width	E2	0.75	0.80	0.85
Terminal Width	b	0.20	0.25	0.30
Terminal Length	L	0.30	0.35	0.40
Terminal-to-Exposed-Pad	K	0.20	-	-

**Notes:**

1. Pin 1 visual index feature may vary, but must be located within the hatched area.
2. Package is saw singulated
3. Dimensioning and tolerancing per ASME Y14.5M

BSC: Basic Dimension. Theoretically exact value shown without tolerances.

REF: Reference Dimension, usually without tolerance, for information purposes only.

Microchip Technology Drawing C04-1016A Sheet 2 of 2

## 6-Lead Very Thin Plastic Dual Flat, No Lead Package (JDA) - 2x2 mm Body [VDFN] Micrel Legacy Package

**Note:** For the most current package drawings, please see the Microchip Packaging Specification located at <http://www.microchip.com/packaging>

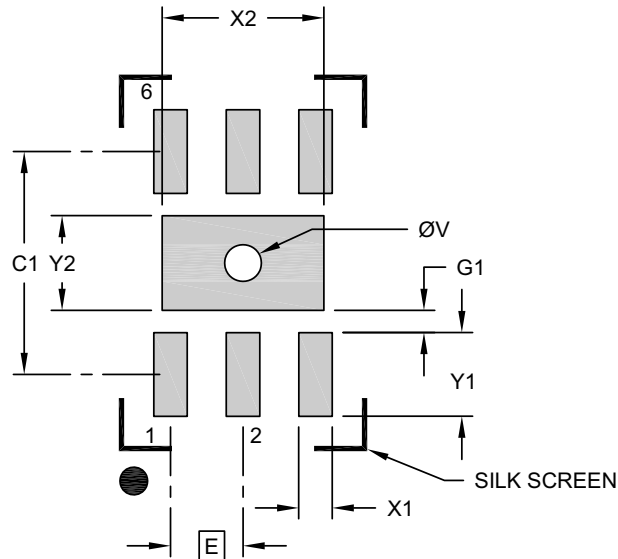

### RECOMMENDED LAND PATTERN

Dimension Limits	Units	MILLIMETERS		
		MIN	NOM	MAX
Contact Pitch	E	0.65 BSC		
Optional Center Pad Width	X2			0.85
Optional Center Pad Length	Y2			1.45
Contact Pad Spacing	C1	2.00		
Contact Pad Width (X6)	X1			0.30
Contact Pad Length (X6)	Y1			0.75
Contact Pad to Center Pad (X6)	G1	0.20		
Thermal Via Diameter	V	0.27	0.30	0.33

**Notes:**

- Dimensioning and tolerancing per ASME Y14.5M  
BSC: Basic Dimension. Theoretically exact value shown without tolerances.
- For best soldering results, thermal vias, if used, should be filled or tented to avoid solder loss during reflow process

Microchip Technology Drawing C04-21016A

# MIC5219

## 6-Lead 2 mm x 2 mm TDFN Package Outline and Recommended Land Pattern

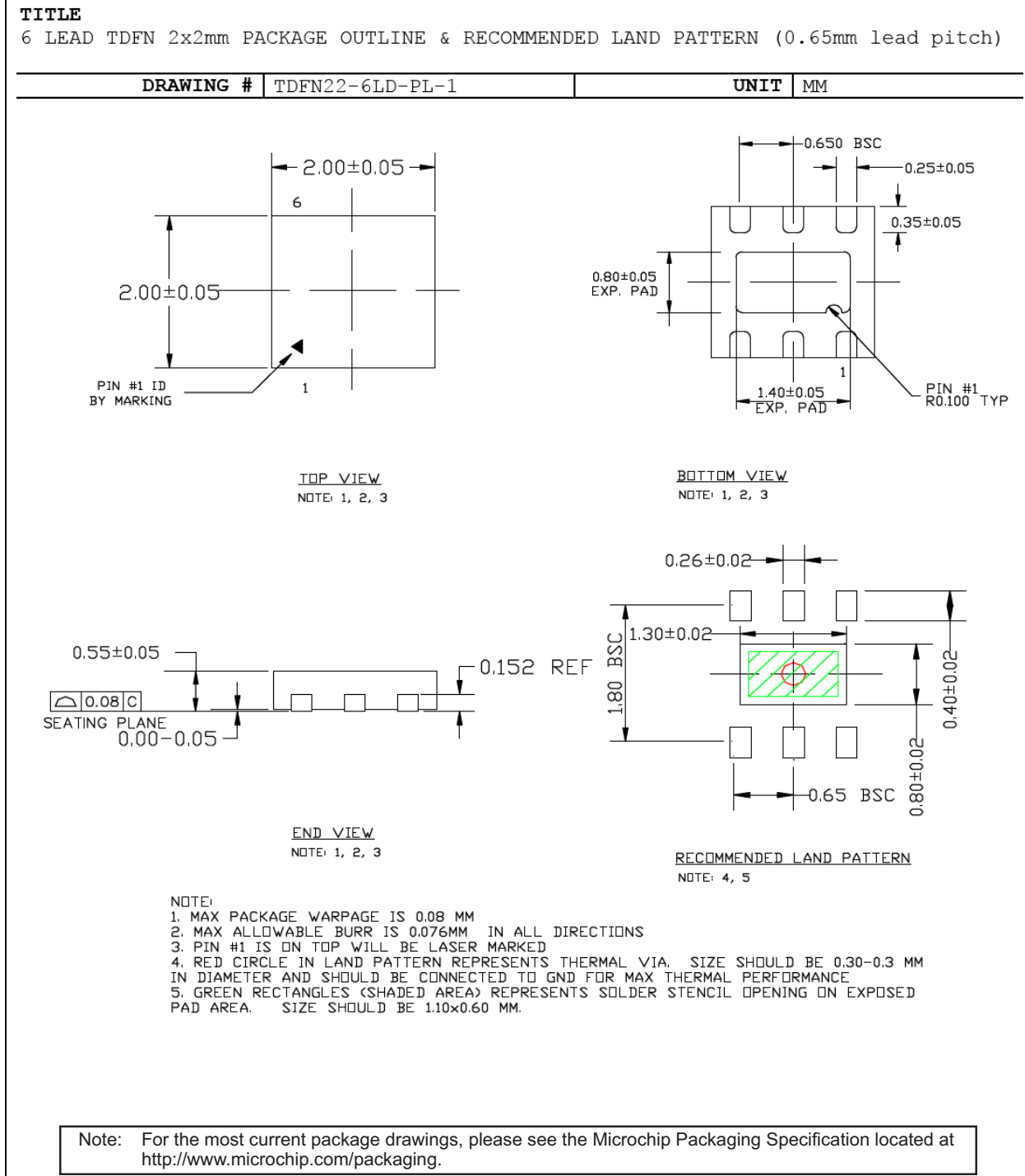



## 8-Lead MSOP Package Outline and Recommended Land Pattern

**TITLE**

8 LEAD MSOP PACKAGE OUTLINE & RECOMMENDED LAND PATTERN

DRAWING #	MSOP-8LD-PL-1	UNIT	INCH [MM]
-----------	---------------	------	-----------

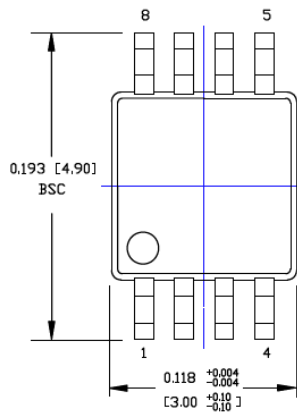

TOP VIEW

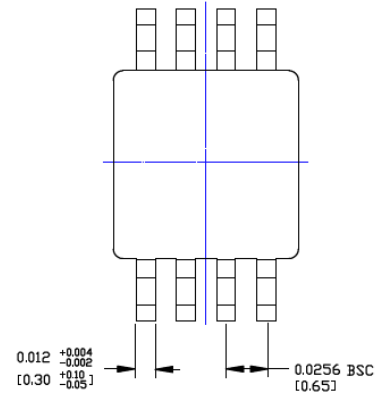

BOTTOM VIEW

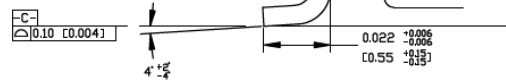

DETAIL A

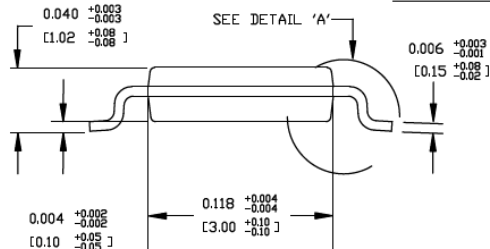

SIDE VIEW

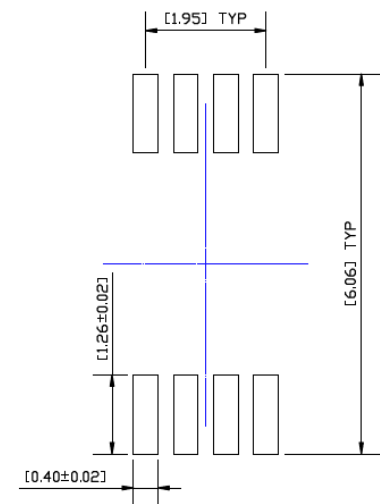

RECOMMENDED LAND PATTERN

**NOTES:**

1. DIMENSIONS ARE IN INCHES [MM].
2. CONTROLLING DIMENSION: MM
3. DIMENSION DOES NOT INCLUDE MOLD FLASH OR PROTRUSIONS, EITHER OF WHICH SHALL NOT EXCEED 0.008 [0.20] PER SIDE.

Note: For the most current package drawings, please see the Microchip Packaging Specification located at <http://www.microchip.com/packaging>.

# MIC5219

---

NOTES:

## APPENDIX A: REVISION HISTORY

### Revision A (May 2018)

- Converted Micrel document MIC5219 to Microchip data sheet DS20006021A.
- Minor text changes throughout.

# MIC5219

---

NOTES:

## PRODUCT IDENTIFICATION SYSTEM

To order or obtain information, e.g., on pricing or delivery, contact your local Microchip representative or sales office.

Device	<u>XX</u>	<u>X</u>	<u>XX</u>	<u>-XX</u>																																							
Part No.	Voltage	Junction Temp. Range	Package	Media Type																																							
<b>Device:</b>	MIC5219:	500 mA Peak Output LDO Regulator																																									
<b>Voltage:</b>	2.5 = 2.5V (SOT23, MSOP Packages) 2.6 = 2.6V (SOT23 Package) 2.7 = 2.7V (SOT23 Package) 2.8 = 2.8V (VDFN Package) 2.85 = 2.85V (SOT23, MSOP Packages) 2.9 = 2.9V (SOT23 Package) 3.0 = 3.0V (SOT23, MSOP, VDFN Packages) 3.1 = 3.1V (SOT23 Package) 3.3 = 3.3V (SOT23, MSOP, VDFN Packages) 3.6 = 3.6V (SOT23, MSOP Packages) 5.0 = 5.0V (SOT23, MSOP, TDFN Packages) <blank> = ADJ (SOT23, MSOP, TDFN Packages)																																										
<b>Junction Temperature Range:</b>	Y	= -40°C to +125°C																																									
<b>Package:</b>	M5 = 5-Lead SOT23 ML = 6-Lead 2 mm x 2 mm x 0.9 mm VDFN MT = 6-Lead 2 mm x 2 mm x 0.6 mm TDFN MM = 8-Lead MSOP																																										
<b>Media Type:</b>	TR = 3,000/Reel (SOT23) TX = 3,000/Reel (SOT23 Reverse Pin 1 orientation) TR = 2,500/Reel (MSOP) TR = 5,000/Reel (VDFN and TDFN) <blank> = 100/Tube (MSOP)																																										
Note: Other voltage options available. Contact your Microchip Sales Office.																																											
<b>Examples:</b>																																											
a) 5-Lead SOT23, 500 mA Peak Output Current Capability, Adjustable & Fixed Output Voltages, 3,000/Reel.																																											
<table border="1"> <thead> <tr> <th>Catalog P/N</th> <th>Output Voltage</th> <th>Marking Code</th> </tr> </thead> <tbody> <tr><td>MIC5219-2.5YM5-TR</td><td>2.5V</td><td>LG25</td></tr> <tr><td>MIC5219-2.6YM5-TR</td><td>2.6V</td><td>LG26</td></tr> <tr><td>MIC5219-2.7YM5-TR</td><td>2.7V</td><td>LG27</td></tr> <tr><td>MIC5219-2.8YM5-TR</td><td>2.8V</td><td>LG28</td></tr> <tr><td>MIC5219-2.85YM5-TR</td><td>2.85V</td><td>LG2J</td></tr> <tr><td>MIC5219-2.9YM5-TR</td><td>2.9V</td><td>LG29</td></tr> <tr><td>MIC5219-3.0YM5-TR</td><td>3.0V</td><td>LG30</td></tr> <tr><td>MIC5219-3.1YM5-TR</td><td>3.1V</td><td>LG31</td></tr> <tr><td>MIC5219-3.3YM5-TR</td><td>3.3V</td><td>LG33</td></tr> <tr><td>MIC5219-3.6YM5-TR</td><td>3.6V</td><td>LG36</td></tr> <tr><td>MIC5219-5.0YM5-TR</td><td>5.0V</td><td>LG50</td></tr> <tr><td>MIC5219YM5-TR</td><td>Adjustable</td><td></td></tr> </tbody> </table>					Catalog P/N	Output Voltage	Marking Code	MIC5219-2.5YM5-TR	2.5V	LG25	MIC5219-2.6YM5-TR	2.6V	LG26	MIC5219-2.7YM5-TR	2.7V	LG27	MIC5219-2.8YM5-TR	2.8V	LG28	MIC5219-2.85YM5-TR	2.85V	LG2J	MIC5219-2.9YM5-TR	2.9V	LG29	MIC5219-3.0YM5-TR	3.0V	LG30	MIC5219-3.1YM5-TR	3.1V	LG31	MIC5219-3.3YM5-TR	3.3V	LG33	MIC5219-3.6YM5-TR	3.6V	LG36	MIC5219-5.0YM5-TR	5.0V	LG50	MIC5219YM5-TR	Adjustable	
Catalog P/N	Output Voltage	Marking Code																																									
MIC5219-2.5YM5-TR	2.5V	LG25																																									
MIC5219-2.6YM5-TR	2.6V	LG26																																									
MIC5219-2.7YM5-TR	2.7V	LG27																																									
MIC5219-2.8YM5-TR	2.8V	LG28																																									
MIC5219-2.85YM5-TR	2.85V	LG2J																																									
MIC5219-2.9YM5-TR	2.9V	LG29																																									
MIC5219-3.0YM5-TR	3.0V	LG30																																									
MIC5219-3.1YM5-TR	3.1V	LG31																																									
MIC5219-3.3YM5-TR	3.3V	LG33																																									
MIC5219-3.6YM5-TR	3.6V	LG36																																									
MIC5219-5.0YM5-TR	5.0V	LG50																																									
MIC5219YM5-TR	Adjustable																																										
b) 6-Lead VDFN, 500 mA Continuous Output Current Capability, Adjustable & Fixed Output Voltages, 5,000/Reel																																											
<table border="1"> <thead> <tr> <th>Catalog P/N</th> <th>Output Voltage</th> <th>Marking Code</th> </tr> </thead> <tbody> <tr><td>MIC5219-2.8YML-TR</td><td>2.8V</td><td>G28</td></tr> <tr><td>MIC5219-3.0YML-TR</td><td>3.0V</td><td>G30</td></tr> <tr><td>MIC5219-3.3YML-TR</td><td>3.3V</td><td>G33</td></tr> <tr><td>MIC5219-3.6YML-TR</td><td>3.6V</td><td>G36</td></tr> </tbody> </table>					Catalog P/N	Output Voltage	Marking Code	MIC5219-2.8YML-TR	2.8V	G28	MIC5219-3.0YML-TR	3.0V	G30	MIC5219-3.3YML-TR	3.3V	G33	MIC5219-3.6YML-TR	3.6V	G36																								
Catalog P/N	Output Voltage	Marking Code																																									
MIC5219-2.8YML-TR	2.8V	G28																																									
MIC5219-3.0YML-TR	3.0V	G30																																									
MIC5219-3.3YML-TR	3.3V	G33																																									
MIC5219-3.6YML-TR	3.6V	G36																																									
c) 6-Lead TDFN, 500 mA Continuous Output Current Capability, Adjustable & Fixed Output Voltages, 5,000/Reel																																											
<table border="1"> <thead> <tr> <th>Catalog P/N</th> <th>Output Voltage</th> <th>Marking Code</th> </tr> </thead> <tbody> <tr><td>MIC5219-5.0YMT-TR</td><td>5.0V</td><td>G50</td></tr> <tr><td>MIC5219YMT-TR</td><td>Adjustable</td><td>GAA</td></tr> </tbody> </table>					Catalog P/N	Output Voltage	Marking Code	MIC5219-5.0YMT-TR	5.0V	G50	MIC5219YMT-TR	Adjustable	GAA																														
Catalog P/N	Output Voltage	Marking Code																																									
MIC5219-5.0YMT-TR	5.0V	G50																																									
MIC5219YMT-TR	Adjustable	GAA																																									
d) 8-Lead MSOP, 500 mA Continuous Output Current Capability, Adjustable & Fixed Output Voltages, 100/Tube or 2,500/Reel																																											
<table border="1"> <thead> <tr> <th>CPN Bulk</th> <th>Qty</th> <th>CPN T/R</th> <th>Qty</th> </tr> </thead> <tbody> <tr><td>MIC5219-2.5YMM</td><td>100/Tube</td><td>MIC5219-2.5YMM-TR</td><td>2,500/Reel</td></tr> <tr><td>MIC5219-2.85YMM</td><td>100/Tube</td><td>MIC5219-2.85YMM-TR</td><td>2,500/Reel</td></tr> <tr><td>MIC5219-3.0YMM</td><td>100/Tube</td><td>MIC5219-3.0YMM-TR</td><td>2,500/Reel</td></tr> <tr><td>MIC5219-3.3YMM</td><td>100/Tube</td><td>MIC5219-3.3YMM-TR</td><td>2,500/Reel</td></tr> <tr><td>MIC5219-3.6YMM</td><td>100/Tube</td><td>MIC5219-3.6YMM-TR</td><td>2,500/Reel</td></tr> <tr><td>MIC5219-5.0YMM</td><td>100/Tube</td><td>MIC5219-5.0YMM-TR</td><td>2,500/Reel</td></tr> <tr><td>MIC5219YMM</td><td>100/Tube</td><td>MIC5219YMM-TR</td><td>2,500/Reel</td></tr> </tbody> </table>					CPN Bulk	Qty	CPN T/R	Qty	MIC5219-2.5YMM	100/Tube	MIC5219-2.5YMM-TR	2,500/Reel	MIC5219-2.85YMM	100/Tube	MIC5219-2.85YMM-TR	2,500/Reel	MIC5219-3.0YMM	100/Tube	MIC5219-3.0YMM-TR	2,500/Reel	MIC5219-3.3YMM	100/Tube	MIC5219-3.3YMM-TR	2,500/Reel	MIC5219-3.6YMM	100/Tube	MIC5219-3.6YMM-TR	2,500/Reel	MIC5219-5.0YMM	100/Tube	MIC5219-5.0YMM-TR	2,500/Reel	MIC5219YMM	100/Tube	MIC5219YMM-TR	2,500/Reel							
CPN Bulk	Qty	CPN T/R	Qty																																								
MIC5219-2.5YMM	100/Tube	MIC5219-2.5YMM-TR	2,500/Reel																																								
MIC5219-2.85YMM	100/Tube	MIC5219-2.85YMM-TR	2,500/Reel																																								
MIC5219-3.0YMM	100/Tube	MIC5219-3.0YMM-TR	2,500/Reel																																								
MIC5219-3.3YMM	100/Tube	MIC5219-3.3YMM-TR	2,500/Reel																																								
MIC5219-3.6YMM	100/Tube	MIC5219-3.6YMM-TR	2,500/Reel																																								
MIC5219-5.0YMM	100/Tube	MIC5219-5.0YMM-TR	2,500/Reel																																								
MIC5219YMM	100/Tube	MIC5219YMM-TR	2,500/Reel																																								
<b>Note 1:</b> Tape and Reel identifier only appears in the catalog part number description. This identifier is used for ordering purposes and is not printed on the device package. Check with your Microchip Sales Office for package availability with the Tape and Reel option.																																											

# MIC5219

---

NOTES:

---

**Note the following details of the code protection feature on Microchip devices:**

- Microchip products meet the specification contained in their particular Microchip Data Sheet.
- Microchip believes that its family of products is one of the most secure families of its kind on the market today, when used in the intended manner and under normal conditions.
- There are dishonest and possibly illegal methods used to breach the code protection feature. All of these methods, to our knowledge, require using the Microchip products in a manner outside the operating specifications contained in Microchip's Data Sheets. Most likely, the person doing so is engaged in theft of intellectual property.
- Microchip is willing to work with the customer who is concerned about the integrity of their code.
- Neither Microchip nor any other semiconductor manufacturer can guarantee the security of their code. Code protection does not mean that we are guaranteeing the product as “unbreakable.”

Code protection is constantly evolving. We at Microchip are committed to continuously improving the code protection features of our products. Attempts to break Microchip's code protection feature may be a violation of the Digital Millennium Copyright Act. If such acts allow unauthorized access to your software or other copyrighted work, you may have a right to sue for relief under that Act.

---

Information contained in this publication regarding device applications and the like is provided only for your convenience and may be superseded by updates. It is your responsibility to ensure that your application meets with your specifications. MICROCHIP MAKES NO REPRESENTATIONS OR WARRANTIES OF ANY KIND WHETHER EXPRESS OR IMPLIED, WRITTEN OR ORAL, STATUTORY OR OTHERWISE, RELATED TO THE INFORMATION, INCLUDING BUT NOT LIMITED TO ITS CONDITION, QUALITY, PERFORMANCE, MERCHANTABILITY OR FITNESS FOR PURPOSE. Microchip disclaims all liability arising from this information and its use. Use of Microchip devices in life support and/or safety applications is entirely at the buyer's risk, and the buyer agrees to defend, indemnify and hold harmless Microchip from any and all damages, claims, suits, or expenses resulting from such use. No licenses are conveyed, implicitly or otherwise, under any Microchip intellectual property rights unless otherwise stated.

*Microchip received ISO/TS-16949:2009 certification for its worldwide headquarters, design and wafer fabrication facilities in Chandler and Tempe, Arizona; Gresham, Oregon and design centers in California and India. The Company's quality system processes and procedures are for its PIC® MCUs and dsPIC® DSCs, KEELoQ® code hopping devices, Serial EEPROMs, microperipherals, nonvolatile memory and analog products. In addition, Microchip's quality system for the design and manufacture of development systems is ISO 9001:2000 certified.*

**QUALITY MANAGEMENT SYSTEM  
CERTIFIED BY DNV  
= ISO/TS 16949 =**

**Trademarks**

The Microchip name and logo, the Microchip logo, AnyRate, AVR, AVR logo, AVR Freaks, BeaconThings, BitCloud, CryptoMemory, CryptoRF, dsPIC, FlashFlex, flexPWR, Heldo, JukeBlox, KEELoQ, KEELoQ logo, Kleer, LANCheck, LINK MD, maXStylus, maXTouch, MediaLB, megaAVR, MOST, MOST logo, MPLAB, OptoLyzer, PIC, picoPower, PICSTART, PIC32 logo, Prochip Designer, QTouch, RightTouch, SAM-BA, SpyNIC, SST, SST Logo, SuperFlash, tinyAVR, UNI/O, and XMEGA are registered trademarks of Microchip Technology Incorporated in the U.S.A. and other countries.

ClockWorks, The Embedded Control Solutions Company, EtherSynch, Hyper Speed Control, HyperLight Load, IntelliMOS, mTouch, Precision Edge, and Quiet-Wire are registered trademarks of Microchip Technology Incorporated in the U.S.A.

Adjacent Key Suppression, AKS, Analog-for-the-Digital Age, Any Capacitor, AnyIn, AnyOut, BodyCom, chipKIT, chipKIT logo, CodeGuard, CryptoAuthentication, CryptoCompanion, CryptoController, dsPICDEM, dsPICDEM.net, Dynamic Average Matching, DAM, ECAN, EtherGREEN, In-Circuit Serial Programming, ICSP, Inter-Chip Connectivity, JitterBlocker, KleerNet, KleerNet logo, Mindi, MiWi, motorBench, MPASM, MPF, MPLAB Certified logo, MPLIB, MPLINK, MultiTRAK, NetDetach, Omniscient Code Generation, PICDEM, PICDEM.net, PICKit, PICtail, PureSilicon, QMatrix, RightTouch logo, REAL ICE, Ripple Blocker, SAM-ICE, Serial Quad I/O, SMART-I.S., SQI, SuperSwitcher, SuperSwitcher II, Total Endurance, TSHARC, USBCheck, VariSense, ViewSpan, WiperLock, Wireless DNA, and ZENA are trademarks of Microchip Technology Incorporated in the U.S.A. and other countries.

SQTP is a service mark of Microchip Technology Incorporated in the U.S.A.

Silicon Storage Technology is a registered trademark of Microchip Technology Inc. in other countries.

GestIC is a registered trademark of Microchip Technology Germany II GmbH & Co. KG, a subsidiary of Microchip Technology Inc., in other countries.

All other trademarks mentioned herein are property of their respective companies.

© 2018, Microchip Technology Incorporated, All Rights Reserved.  
ISBN: 978-1-5224-2998-2



# MICROCHIP

## Worldwide Sales and Service

### AMERICAS

**Corporate Office**  
2355 West Chandler Blvd.  
Chandler, AZ 85224-6199  
Tel: 480-792-7200  
Fax: 480-792-7277  
Technical Support:  
<http://www.microchip.com/support>  
Web Address:  
[www.microchip.com](http://www.microchip.com)

#### Atlanta

Duluth, GA  
Tel: 678-957-9614  
Fax: 678-957-1455

#### Austin, TX

Tel: 512-257-3370

#### Boston

Westborough, MA  
Tel: 774-760-0087  
Fax: 774-760-0088

#### Chicago

Itasca, IL  
Tel: 630-285-0071  
Fax: 630-285-0075

#### Dallas

Addison, TX  
Tel: 972-818-7423  
Fax: 972-818-2924

#### Detroit

Novi, MI  
Tel: 248-848-4000

#### Houston, TX

Tel: 281-894-5983

#### Indianapolis

Noblesville, IN  
Tel: 317-773-8323  
Fax: 317-773-5453  
Tel: 317-536-2380

#### Los Angeles

Mission Viejo, CA  
Tel: 949-462-9523  
Fax: 949-462-9608  
Tel: 951-273-7800

#### Raleigh, NC

Tel: 919-844-7510

#### New York, NY

Tel: 631-435-6000

#### San Jose, CA

Tel: 408-735-9110  
Tel: 408-436-4270

#### Canada - Toronto

Tel: 905-695-1980  
Fax: 905-695-2078

### ASIA/PACIFIC

**Australia - Sydney**  
Tel: 61-2-9868-6733

**China - Beijing**  
Tel: 86-10-8569-7000

**China - Chengdu**  
Tel: 86-28-8665-5511

**China - Chongqing**  
Tel: 86-23-8980-9588

**China - Dongguan**  
Tel: 86-769-8702-9880

**China - Guangzhou**  
Tel: 86-20-8755-8029

**China - Hangzhou**  
Tel: 86-571-8792-8115

**China - Hong Kong SAR**  
Tel: 852-2943-5100

**China - Nanjing**  
Tel: 86-25-8473-2460

**China - Qingdao**  
Tel: 86-532-8502-7355

**China - Shanghai**  
Tel: 86-21-3326-8000

**China - Shenyang**  
Tel: 86-24-2334-2829

**China - Shenzhen**  
Tel: 86-755-8864-2200

**China - Suzhou**  
Tel: 86-186-6233-1526

**China - Wuhan**  
Tel: 86-27-5980-5300

**China - Xian**  
Tel: 86-29-8833-7252

**China - Xiamen**  
Tel: 86-592-2388138

**China - Zhuhai**  
Tel: 86-756-3210040

### ASIA/PACIFIC

**India - Bangalore**  
Tel: 91-80-3090-4444

**India - New Delhi**  
Tel: 91-11-4160-8631

**India - Pune**  
Tel: 91-20-4121-0141

**Japan - Osaka**  
Tel: 81-6-6152-7160

**Japan - Tokyo**  
Tel: 81-3-6880-3770

**Korea - Daegu**  
Tel: 82-53-744-4301

**Korea - Seoul**  
Tel: 82-2-554-7200

**Malaysia - Kuala Lumpur**  
Tel: 60-3-7651-7906

**Malaysia - Penang**  
Tel: 60-4-227-8870

**Philippines - Manila**  
Tel: 63-2-634-9065

**Singapore**  
Tel: 65-6334-8870

**Taiwan - Hsin Chu**  
Tel: 886-3-577-8366

**Taiwan - Kaohsiung**  
Tel: 886-7-213-7830

**Taiwan - Taipei**  
Tel: 886-2-2508-8600

**Thailand - Bangkok**  
Tel: 66-2-694-1351

**Vietnam - Ho Chi Minh**  
Tel: 84-28-5448-2100

### EUROPE

**Austria - Wels**  
Tel: 43-7242-2244-39  
Fax: 43-7242-2244-393

**Denmark - Copenhagen**  
Tel: 45-4450-2828  
Fax: 45-4485-2829

**Finland - Espoo**  
Tel: 358-9-4520-820

**France - Paris**  
Tel: 33-1-69-53-63-20  
Fax: 33-1-69-30-90-79

**Germany - Garching**  
Tel: 49-8931-9700

**Germany - Haan**  
Tel: 49-2129-3766400

**Germany - Heilbronn**  
Tel: 49-7131-67-3636

**Germany - Karlsruhe**  
Tel: 49-721-625370

**Germany - Munich**  
Tel: 49-89-627-144-0  
Fax: 49-89-627-144-44

**Germany - Rosenheim**  
Tel: 49-8031-354-560

**Israel - Ra'anana**  
Tel: 972-9-744-7705

**Italy - Milan**  
Tel: 39-0331-742611  
Fax: 39-0331-466781

**Italy - Padova**  
Tel: 39-049-7625286

**Netherlands - Drunen**  
Tel: 31-416-690399  
Fax: 31-416-690340

**Norway - Trondheim**  
Tel: 47-7289-7561

**Poland - Warsaw**  
Tel: 48-22-3325737

**Romania - Bucharest**  
Tel: 40-21-407-87-50

**Spain - Madrid**  
Tel: 34-91-708-08-90  
Fax: 34-91-708-08-91

**Sweden - Gothenberg**  
Tel: 46-31-704-60-40

**Sweden - Stockholm**  
Tel: 46-8-5090-4654

**UK - Wokingham**  
Tel: 44-118-921-5800  
Fax: 44-118-921-5820