

General Description

The MIC5309 is a high performance, μ Cap low dropout regulator, offering ultra-low operating current while maintaining very fast transient response. The MIC5309 can source up to 300mA of output current and can regulate down from a low input supply voltage to increase system efficiency.

Ideal for battery operated applications; the MIC5309 offers extremely low dropout voltage 100mV typically @ 300mA load, and low ground current at all load conditions (typically 23 μ A). The MIC5309 can also be put into a zero-off-mode current state, drawing virtually no current when disabled.

The MIC5309 is available in fixed output voltages in the tiny 6-pin 1.6mm x 1.6mm thin MLF® leadless package as well as the 6-pin TSOT-23 for cost sensitive applications.

Data sheets and support documentation can be found on Micrel's web site at: www.micrel.com.

Features

- Input voltage range: 1.7V to 5.5V
- Guaranteed 300mA over temperature
- Ultra Low dropout voltage of 100mV typical 300mA
- High PSRR, up to 90dB @ 1kHz
- Output Voltage range: 0.8V to 2.0V
- Very low ground current – 23 μ A under full load
- Bias supply voltage range: 2.5V to 5.5V
- Stable with 1 μ F ceramic output capacitor
- 300mA maximum output current at 1.7V input voltage
- Very fast transient response – ideal for digital loads
- Thermal shutdown and current limit protection
- Tiny 6-pin 1.6mm x 1.6mm Thin MLF® package
- Cost effective 6-pin TSOT-23 package

Applications

- Mobile Phones
- PDAs
- GPS Receivers
- Portable Electronics

Typical Application

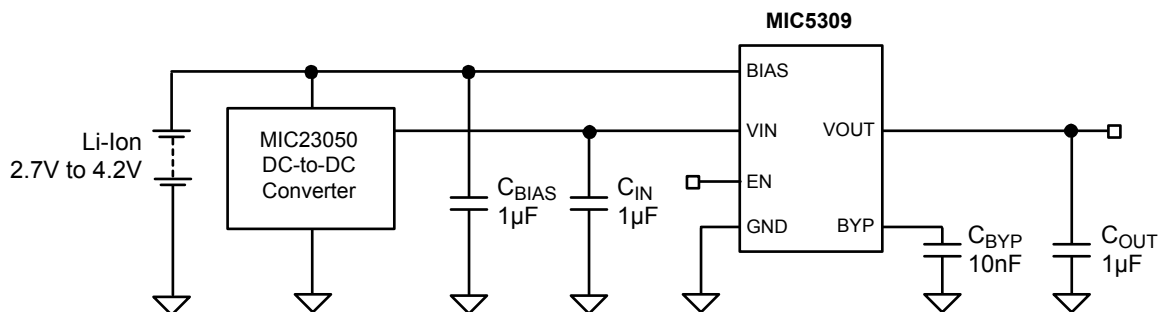

ULDO is a trademark of Micrel, Inc.

MLF and *MicroLeadFrame* are registered trademarks of Amkor Technology, Inc.

Micrel Inc. • 2180 Fortune Drive • San Jose, CA 95131 • USA • tel +1 (408) 944-0800 • fax + 1 (408) 474-1000 • <http://www.micrel.com>

Ordering Information

Part Number	Voltage	Marking Codes	Temperature Range	Package
MIC5309-1.2YMT	1.2V	▲1S2	-40° to +125°C	6-Pin 1.6mm x 1.6mm Thin MLF [®]
MIC5309-1.5YMT	1.5V	▲1S5	-40° to +125°C	6-Pin 1.6mm x 1.6mm Thin MLF [®]
MIC5309-1.8YMT	1.8V	▲1S8	-40° to +125°C	6-Pin 1.6mm x 1.6mm Thin MLF [®]
MIC5309YMT	Adj.	▲ASA	-40° to +125°C	6-Pin 1.6mm x 1.6mm Thin MLF [®]
MIC5309-1.2YD6	1.2V	QS12	-40° to +125°C	6-Pin TSOT-23
MIC5309-1.5YD6	1.5V	QS15	-40° to +125°C	6-Pin TSOT-23
MIC5309-1.8YD6	1.8V	QS18	-40° to +125°C	6-Pin TSOT-23
MIC5309YD6	Adj.	QSAA	-40° to +125°C	6-Pin TSOT-23

Notes

For other voltage options. Contact Micrel Marketing for details.

Pin 1 identifier = ▲.

MLF[®] is a GREEN RoHS compliant package. Lead finish is NiPdAu. Mold compound is Halogen Free.

Pin Configuration

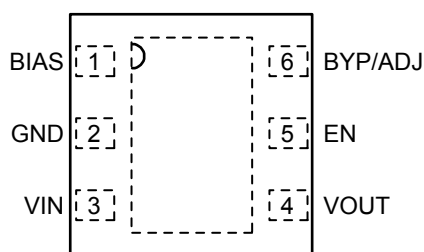

6-Pin 1.6mm x 1.6mm Thin MLF[®] (MT)

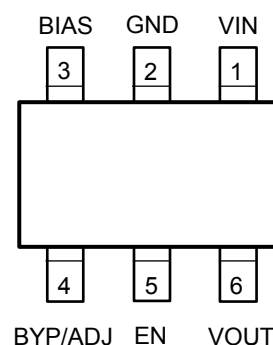

6-Pin TSOT-23 (D6)

Pin Description

Pin Number Thin MLF-6	Pin Number TSOT-23-6	Pin Name	Pin Function
3	1	VIN	Power Input for LDO.
2	2	GND	Ground
1	3	BIAS	Bias Input Voltage.
6	4	BYP	Bypass: Connect a capacitor to ground to reduce noise and reduce ripple rejection.
		ADJ	Adjustable: Feedback input from external resistor divider.
5	5	EN	Enable Input: Active High Input. Logic High = On; Logic Low = Off; Do not leave floating.
4	6	VOUT	Output of regulator.
HS Pad	–	EPAD	Exposed heatsink pad connected to ground internally.

Absolute Maximum Ratings⁽¹⁾

Supply Voltage (V_{IN})	0V to V_{BIAS}
Bias Supply Voltage (V_{BIAS})	0V to +6V
Enable Voltage (V_{EN})	0V to V_{BIAS}
Power Dissipation,	Internally Limited ⁽³⁾
Lead Temperature (soldering, 10 μ sec.)	260°C
Storage Temperature (T_s)	-65°C to +150°C
ESD Rating ⁽⁴⁾	3kV

Operating Ratings⁽²⁾

Supply Voltage (V_{IN})	+1.7V to V_{BIAS}
Bias Supply Voltage (V_{BIAS})	+2.5V to +5.5V
Enable Input Voltage (V_{EN})	0V to V_{BIAS}
Junction Temperature (T_J)	-40°C to +125°C
Junction Thermal Resistance	
1.6x1.6 MLF-6 (θ_{JA})	90°C/W
TSOT-23-6 (θ_{JA})	235°C/W

Electrical Characteristics

$V_{BIAS} = 3.6V$; $V_{IN} = V_{OUT} + 1V$; $V_{IN} \leq V_{BIAS}$; $C_{OUT} = 1.0\mu F$; $I_{OUT} = 100\mu A$; $T_J = 25^\circ C$, **bold** values indicate $-40^\circ C$ to $+125^\circ C$, unless noted.

Parameter	Condition	Min	Typ	Max	Units
Output Voltage Accuracy	Variation from nominal V_{OUT}	-2.0		+2.0	%
Reference Voltage	ADJ pin voltage	0.7595	0.775	0.7905	V
V_{BIAS} Line Regulation	$V_{BIAS} = 3.6$ to $5.5V$, $V_{IN} = V_{OUT} + 1V$		0.01	0.3	%/V
V_{IN} Line Regulation	$V_{IN} = V_{OUT} + 1V$, $V_{BIAS} = 5.5V$		0.02	0.2	%/V
Load Regulation	$I_{OUT} = 100\mu A$ to $300mA$		0.4	2	%
Dropout Voltage	$I_{OUT} = 300mA$		100	200	mV
Ground Pin Current ⁽⁵⁾	$I_{OUT} = 100\mu A$ to $300mA$, $V_{EN} = V_{BIAS}$		23	35	μA
Ground Pin Current in Shutdown	$V_{EN} \leq 0.2V$		0.01	2.0	μA
V_{IN} Ripple Rejection	$f =$ up to $1kHz$; $C_{OUT} = 1.0\mu F$; no C_{BYP}		70		dB
	$f =$ up to $1kHz$; $C_{OUT} = 1.0\mu F$; $C_{BYP} = 10nF$	50	90		dB
	$f = 20kHz$; $C_{OUT} = 1.0\mu F$; $C_{BYP} = 10nF$		80		dB
Current Limit	$V_{OUT} = 0V$	350	550	800	mA
Output Voltage Noise	$C_{OUT} = 1.0\mu F$, $C_{BYP} = 10nF$, $10Hz$ to $100kHz$		28		μV_{RMS}
Enable Inputs (EN)					
Enable Input Voltage	Logic Low			0.2	V
	Logic High	1.2			V
Enable Input Current	$V_{IL} \leq 0.2V$		0.17	1	μA
	$V_{IH} \geq 1.2V$		1.5	1	μA
Turn-on Time	$C_{OUT} = 1.0\mu F$, $C_{BYP} = 10nF$		150	500	μs

Notes:

- Exceeding the absolute maximum rating may damage the device.
- The device is not guaranteed to function outside its operating rating.
- The maximum allowable power dissipation of any T_A (ambient temperature) is $P_{D(max)} = (T_{J(max)} - T_A) / \theta_{JA}$. Exceeding the maximum allowable power dissipation will result in excessive die temperature, and the regulator will go into thermal shutdown.
- Devices are ESD sensitive. Handling precautions recommended. Human body model, $1.5k\Omega$ in series with $100pF$.
- $I_{GND} = I_{IN} + I_{BIAS} - I_{OUT}$.

Typical Characteristics

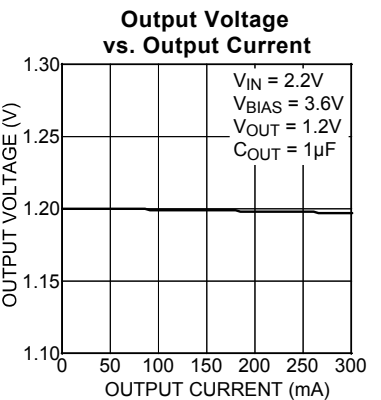
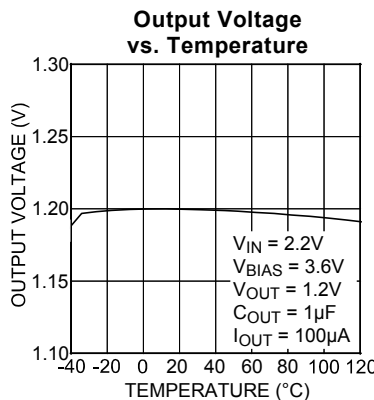
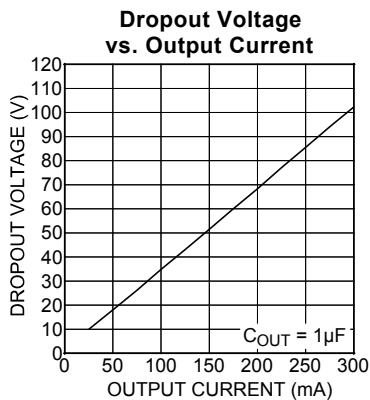
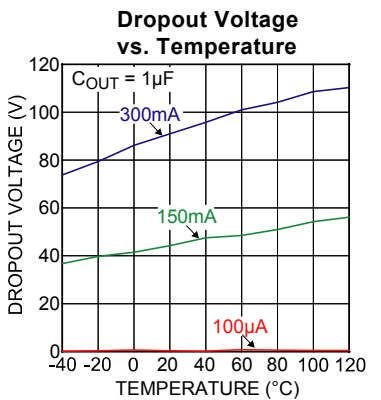
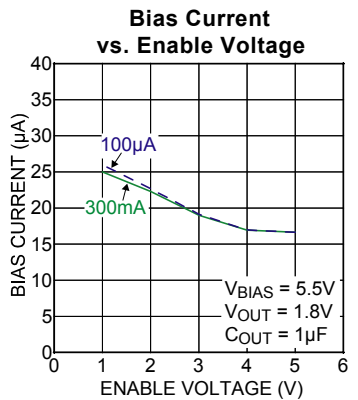
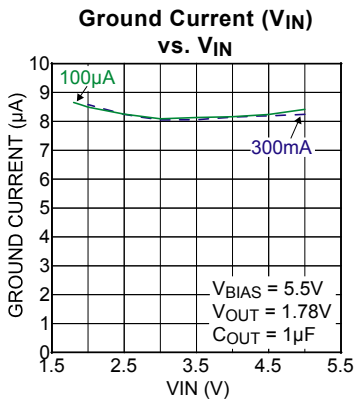
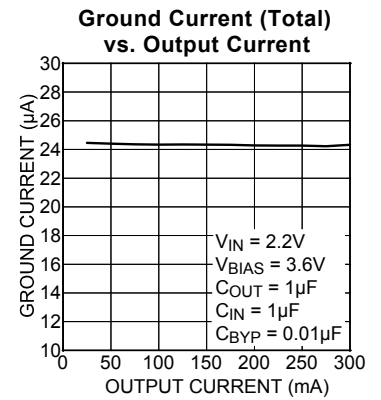
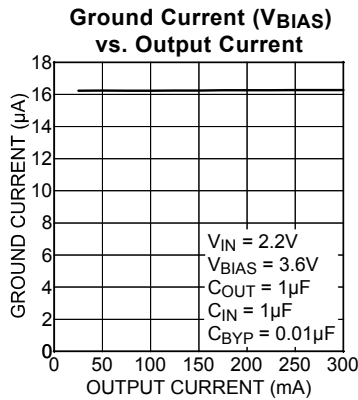
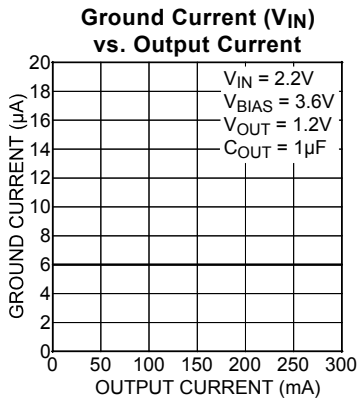
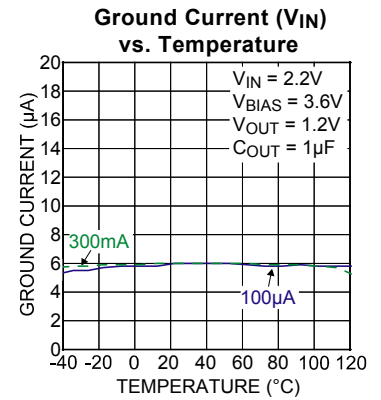
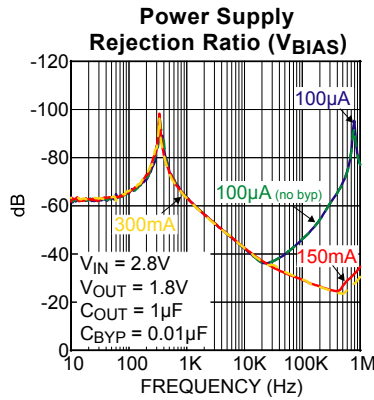
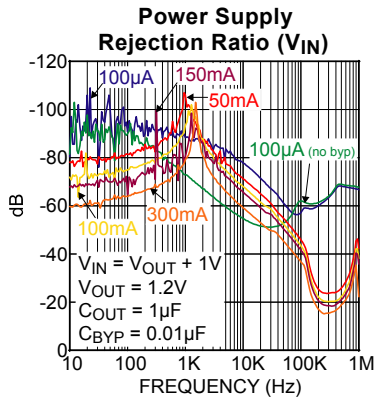

Typical Characteristics

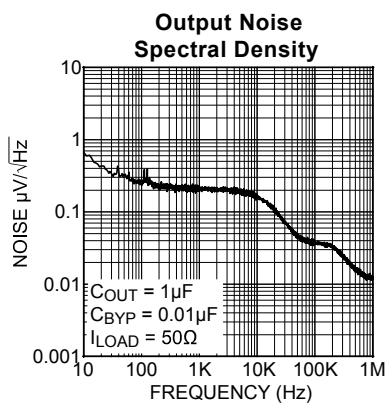
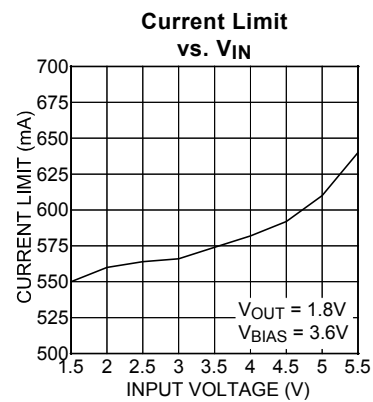
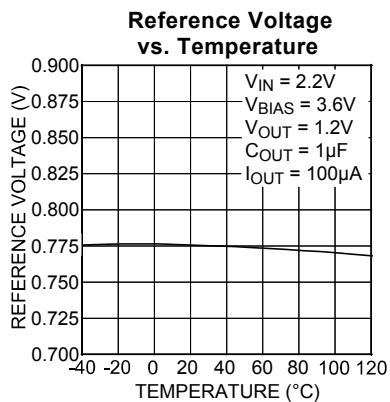
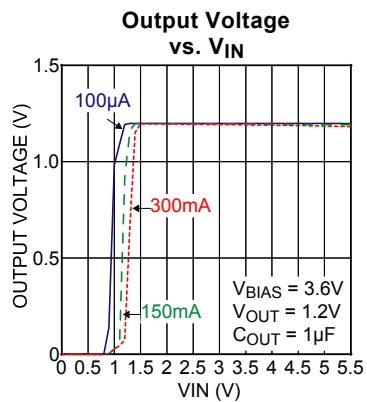

Functional Characteristics

Enable Turn-On

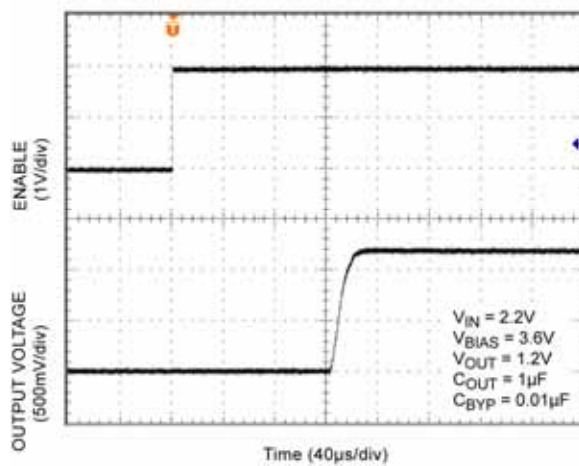

Load Transient

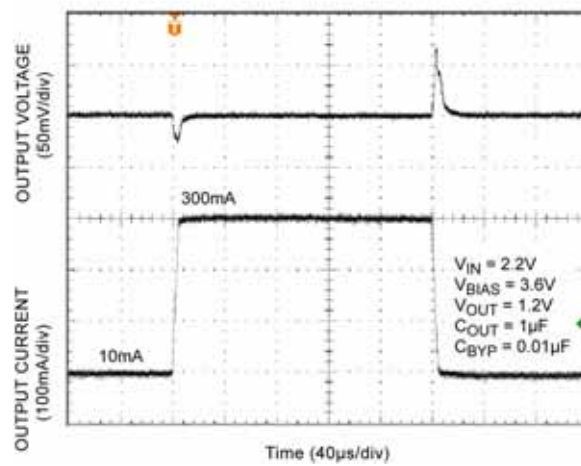

Line Transient (V_{IN})

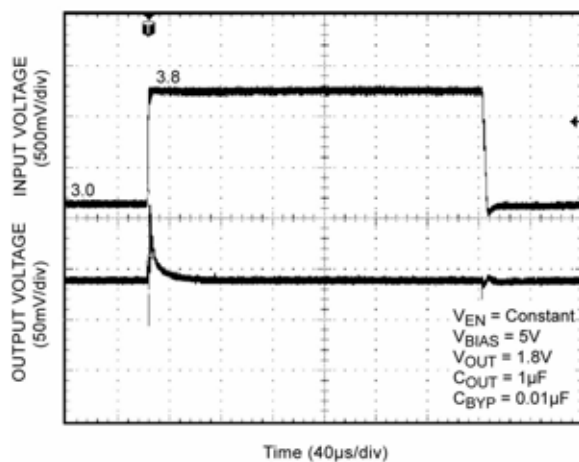

Line Transient (V_{BIAS})

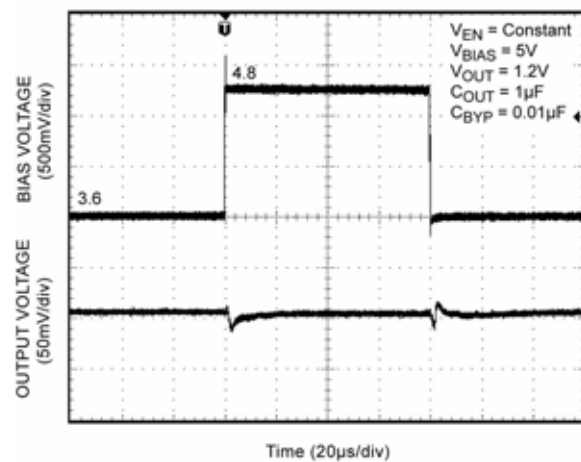

Functional Diagram

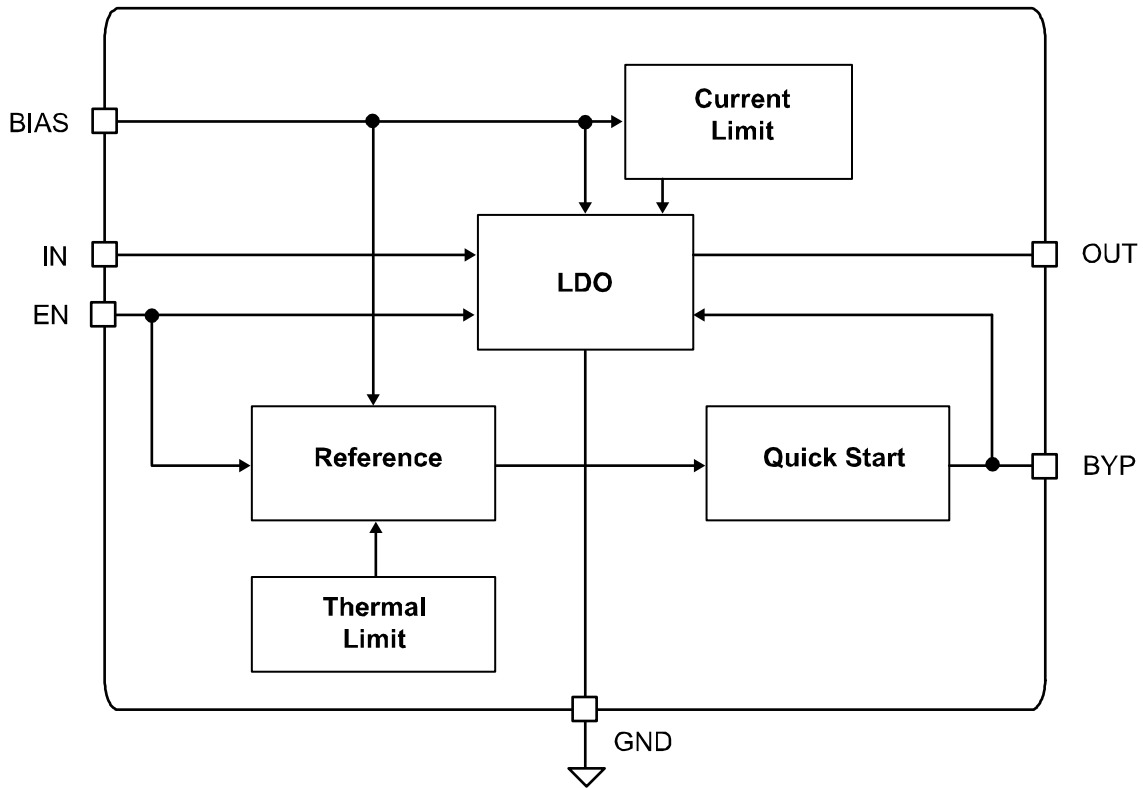

MIC5309 Block Diagram

Applications Information

The MIC5309 is a high performance, low-dropout linear regulator designed for low current applications requiring fast transient response. The MIC5309 utilizes two input supplies, significantly reducing dropout voltage, perfect for low-voltage, DC-to-DC conversion. The MIC5309 requires a minimum of external components.

The MIC5309 regulator is fully protected from damage due to fault conditions, offering linear current limiting and thermal shutdown.

Bias Supply Voltage

V_{BIAS} , requiring relatively light current, provides power to the control portion of the MIC5309. Bypassing on the bias pin is recommended to improve performance of the regulator during line and load transients. $1\mu\text{F}$ ceramic capacitor from V_{BIAS} to ground helps reduce high frequency noise from being injected into the control circuitry from the bias rail and is good design practice.

Input Supply Voltage

V_{IN} provides the supply to power the LDO. The minimum input voltage is 1.7V, allowing conversion from low voltage supplies.

Output Capacitor

The MIC5309 requires an output capacitor of $1\mu\text{F}$ or greater to maintain stability. The design is optimized for use with low-ESR ceramic chip capacitors. High ESR capacitors may cause high frequency oscillation. The output capacitor can be increased, but performance has been optimized for a $1\mu\text{F}$ ceramic output capacitor and does not improve significantly with larger capacitance.

X7R/X5R dielectric-type ceramic capacitors are recommended because of their temperature performance. X7R-type capacitors change capacitance by 15% over their operating temperature range and are the most stable type of ceramic capacitors. Z5U and Y5V dielectric capacitors change value by as much as 50% and 60%, respectively, over their operating temperature ranges. To use a ceramic chip capacitor with Y5V dielectric, the value must be much higher than an X7R ceramic capacitor to ensure the same minimum capacitance over the equivalent operating temperature range.

Input Capacitor

The MIC5309 is a high-performance, high bandwidth device. Therefore, it requires a well-bypassed input supply for optimal performance. A $1\mu\text{F}$ capacitor is required from the input to ground to provide stability. Low-ESR ceramic capacitors provide optimal performance at a minimum of space. Additional high-frequency capacitors, such as small-valued NPO dielectric-type capacitors, help filter out high-frequency noise and are good practice in any RF-based circuit.

Bypass Capacitor

A capacitor can be placed from the noise bypass pin to ground to reduce output voltage noise. The capacitor bypasses the internal reference. A $0.01\mu\text{F}$ capacitor is recommended for applications that require low-noise outputs. The bypass capacitor can be increased, further reducing noise and improving PSRR. Turn-on time increases slightly with respect to bypass capacitance. A unique, quick-start circuit allows the MIC5309 to drive a large capacitor on the bypass pin without significantly slowing turn-on time.

Minimum Load Current

The MIC5309, unlike most other regulators, does not require a minimum load to maintain output voltage regulation.

Adjustable Regulator Design

The MIC5309 adjustable version allows programming the output voltage anywhere between 0.8V and 2V. Two resistors are used. The resistor values are calculated by:

$$R1 = R2 \times \left(\frac{V_{OUT}}{0.775} - 1 \right)$$

Where V_{OUT} is the desired output voltage.

Enable/Shutdown

The MIC5309 comes with a single active-high enable pin that allows the regulator to be disabled. Forcing the enable pin low disables the regulator and sends it into a "zero" off-mode-current state. In this state, current consumed by the regulator goes nearly to zero. Forcing the enable pin high enables the output voltage. The active-high enable pin uses CMOS technology and the enable pin cannot be left floating; a floating enable pin may cause an indeterminate state on the output.

Thermal Considerations

The MIC5309 is designed to provide 300mA of continuous current in a very small package. Maximum ambient operating temperature can be calculated based on the output current and the voltage drop across the part. Given that the input voltage is 1.8V, the output voltage is 1.2V and the output current = 300mA. The actual power dissipation of the regulator circuit can be determined using the equation:

$$P_D = (V_{IN} - V_{OUT}) I_{OUT} + V_{IN} I_{GND}$$

Because this device is CMOS and the ground current is typically $<100\mu\text{A}$ over the load range, the power dissipation contributed by the ground current is $<1\%$ and can be ignored for this calculation.

$$P_D = (1.8V - 1.2V) \times 300\text{mA}$$

$$P_D = 0.18\text{W}$$

To determine the maximum ambient operating temperature of the package, use the junction-to-ambient thermal resistance of the device and the following basic equation:

$$P_{D(\max)} = \left(\frac{T_{J(\max)} - T_A}{\theta_{JA}} \right)$$

$T_{J(\max)} = 125^\circ\text{C}$, the maximum junction temperature of the die
 θ_{JA} thermal resistance = 90°C/W .

Package Information

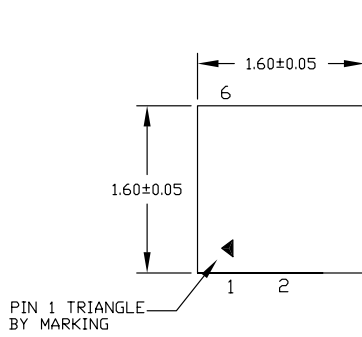

TOP VIEW

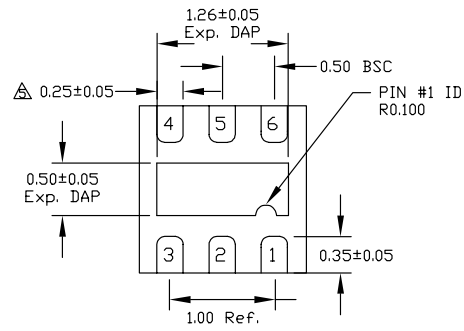

BOTTOM VIEW

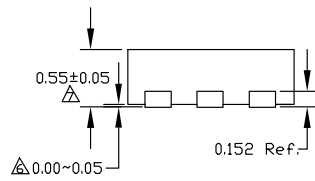

SIDE VIEW

- NOTE:
1. ALL DIMENSIONS ARE IN MILLIMETERS.
 2. MAX. PACKAGE WARPAGE IS 0.05 mm.
 3. MAXIMUM ALLOWABLE BURRS IS 0.076 mm IN ALL DIRECTIONS.
 4. PIN #1 ID ON TOP WILL BE LASER/INK MARKED.
 - △ DIMENSION APPLIES TO METALIZED TERMINAL AND IS MEASURED BETWEEN 0.20 AND 0.25 mm FROM TERMINAL TIP.
 - △ APPLIED ONLY FOR TERMINALS.
 - △ APPLIED FOR EXPOSED PAD AND TERMINALS.

6-Pin 1.6mm x 1.6mm Thin MLF® (MT)

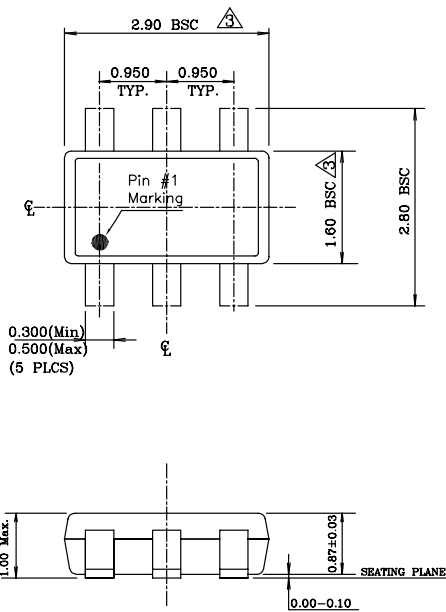

- NOTE:
1. Dimensions and tolerances are as per ANSI Y14.5M, 1994.
 2. Die is facing up for mold. Die is facing down for trim/form, ie. reverse trim/form.
 - △ Dimensions are exclusive of mold flash and gate burr.
 4. The footlength measuring is based on the gauge plane method.
 5. All specification comply to Jedec Spec MO193 Issue C.
 6. All dimensions are in millimeters.

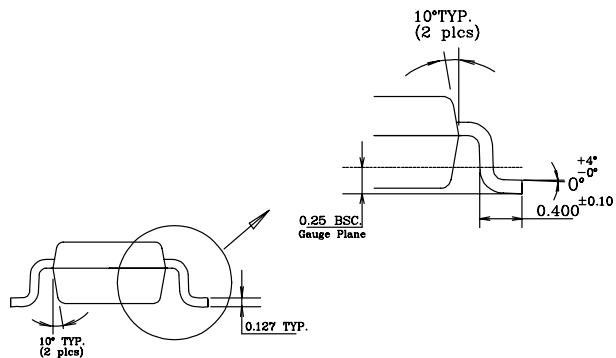

6-Pin TSOT-23 (D6)

MICREL, INC. 2180 FORTUNE DRIVE SAN JOSE, CA 95131 USA
TEL +1 (408) 944-0800 FAX +1 (408) 474-1000 WEB <http://www.micrel.com>

The information furnished by Micrel in this data sheet is believed to be accurate and reliable. However, no responsibility is assumed by Micrel for its use. Micrel reserves the right to change circuitry and specifications at any time without notification to the customer.

Micrel Products are not designed or authorized for use as components in life support appliances, devices or systems where malfunction of a product can reasonably be expected to result in personal injury. Life support devices or systems are devices or systems that (a) are intended for surgical implant into the body or (b) support or sustain life, and whose failure to perform can be reasonably expected to result in a significant injury to the user. A Purchaser's use or sale of Micrel Products for use in life support appliances, devices or systems is a Purchaser's own risk and Purchaser agrees to fully indemnify Micrel for any damages resulting from such use or sale.

© 2007 Micrel, Incorporated.