

# 1N3070-1

## FEATURES

- 1N3070-1 AVAILABLE IN JAN, JANTX, AND JANTXV PER MIL-PRF-19500/169
- SWITCHING DIODE
- METALLURGICALLY BONDED
- HERMETICALLY SEALED
- DOUBLE PLUG CONSTRUCTION

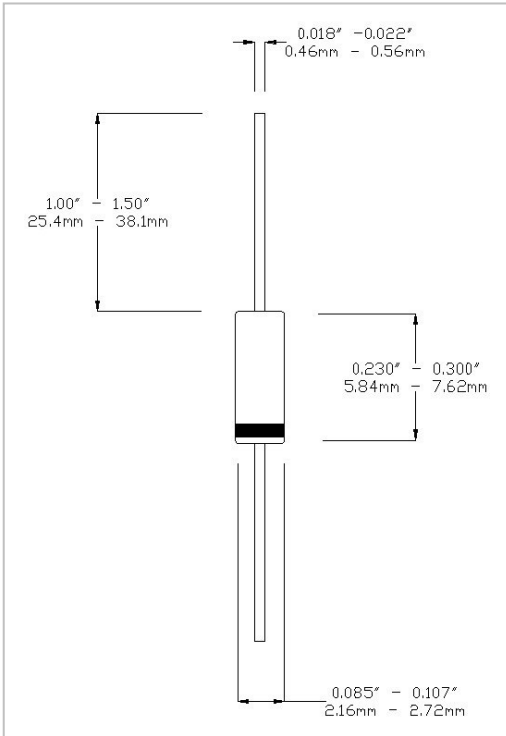

## MAXIMUM RATINGS AT 25 °C

Operating Temperature:	-65°C to +175°C
Storage Temperature:	-65°C to +175°C
Surge Current A, sine, 1uS:	2.0A
Surge Current B, sine, 1S:	0.5A
Total Power Dissipation:	500mW
Operating Current:	100mA, T <sub>A</sub> = +25°C
Derating Factor:	0.667mA/°C above T <sub>A</sub> = +25°C
D.C. Reverse Voltage (VRWM):	175V

## DC ELECTRICAL CHARACTERISTICS

V <sub>F</sub>				I <sub>R</sub>				V <sub>BR</sub>			
Ambient (°C)	I <sub>F</sub> mA	Min V	Max V	Ambient (°C)	V (dc)	Min μA	Max μA	Ambient (°C)	I <sub>R</sub> μA	Min V	Max V
25	100	-	1.0	25	175	-	0.1	25	100	200	-
-55	100	-	1.2	150	175	-	100				

## DESIGN DATA

**Case:** Hermetically sealed glass package per MIL-PRF-19500/169 DO-7 outline

**Lead Material:** Copper clad steel

**Lead Finish:** Tin/Lead

**Thermal Resistance (R<sub>θJL</sub>):** 250°C/W maximum at L=.375"

**Thermal Impedance (Z<sub>θJX</sub>):** 70°C/W maximum

**Marking:** Alpha numeric.

**Polarity:** Cathode end is banded.

## AC ELECTRICAL CHARACTERISTICS AT 25°C

	Symbol	Min	Max
Capacitance @ 0V	pF	-	5
T <sub>RR</sub> @ I <sub>F</sub> =I <sub>R</sub> =30mA, I <sub>Rec</sub> =3mA.	nsec	-	50



WWW.MICROSEMI.COM

IRELAND - GORT ROAD, ENNIS, CO. CLARE

PHONE: +353 65 6840044

TOLL FREE: +186 62 702434

FAX: +353 65 6822298

U.S.A. DOMESTIC SALES CONTACT

PHONE: (617) 926 0404

TOLL FREE: 1 800 666 2999