

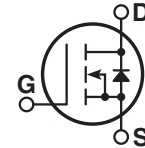

Super Junction MOSFET

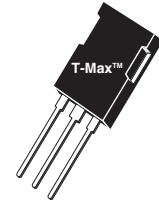

- Ultra Low $R_{DS(ON)}$
- Low Miller Capacitance
- Ultra Low Gate Charge, Q_g
- Avalanche Energy Rated
- Extreme dv/dt Rated
- Dual die (parallel)
- Popular T-MAX Package

Unless stated otherwise, Microsemi discrete MOSFETs contain a single MOSFET die. This device is made with two parallel MOSFET die. It is intended for switch-mode operation. It is not suitable for linear mode operation.

MAXIMUM RATINGS

All Ratings per die: $T_C = 25^\circ\text{C}$ unless otherwise specified.

Symbol	Parameter	APT94N65B2C3G	UNIT
V_{DSS}	Drain-Source Voltage	650	Volts
I_D	Continuous Drain Current @ $T_C = 25^\circ\text{C}$ ①	94	Amps
	Continuous Drain Current @ $T_C = 100^\circ\text{C}$	60	
I_{DM}	Pulsed Drain Current ②	282	
V_{GS}	Gate-Source Voltage Continuous	20	Volts
P_D	Total Power Dissipation @ $T_C = 25^\circ\text{C}$	833	Watts
T_J, T_{STG}	Operating and Storage Junction Temperature Range	-55 to 150	$^\circ\text{C}$
T_L	Lead Temperature: 0.063" from Case for 10 Sec.	260	
dv/dt	Drain-Source Voltage slope ($V_{DS} = 480\text{V}$, $I_D = 94\text{A}$, $T_J = 125^\circ\text{C}$)	50	V/ns
I_{AR}	Avalanche Current ②	7	Amps
E_{AR}	Repetitive Avalanche Energy ③ ($I_D = 3.5\text{A}$, $V_{DD} = 50\text{V}$)	1	mJ
E_{AS}	Single Pulse Avalanche Energy ($I_D = 3.5\text{A}$, $V_{DD} = 50\text{V}$)	1800	

STATIC ELECTRICAL CHARACTERISTICS

Symbol	Characteristic / Test Conditions	MIN	TYP	MAX	UNIT
$BV_{(DSS)}$	Drain-Source Breakdown Voltage ($V_{GS} = 0\text{V}$, $I_D = 500\mu\text{A}$)	650			Volts
$R_{DS(on)}$	Drain-Source On-State Resistance ③ ($V_{GS} = 10\text{V}$, $I_D = 47\text{A}$)		0.03	0.035	Ohms
I_{DSS}	Zero Gate Voltage Drain Current ($V_{DS} = 650\text{V}$, $V_{GS} = 0\text{V}$)		1.0	50	μA
	Zero Gate Voltage Drain Current ($V_{DS} = 650\text{V}$, $V_{GS} = 0\text{V}$, $T_C = 150^\circ\text{C}$)		100		
I_{GSS}	Gate-Source Leakage Current ($V_{GS} = \pm 20\text{V}$, $V_{DS} = 0\text{V}$)			± 200	nA
$V_{GS(th)}$	Gate Threshold Voltage ($V_{DS} = V_{GS}$, $I_D = 5.8\text{mA}$)	2.1	3	3.9	Volts

 CAUTION: These Devices are Sensitive to Electrostatic Discharge. Proper Handling Procedures Should Be Followed.

"COOLMOS™" comprise a new family of transistors developed by Infineon Technologies AG. "COOLMOS" is a trademark of Infineon Technologies AG.

Microsemi Website - <http://www.microsemi.com>

DYNAMIC CHARACTERISTICS

APT94N65B2C3G

Symbol	Characteristic	Test Conditions	MIN	TYP	MAX	UNIT
C_{iss}	Input Capacitance	$V_{GS} = 0V$ $V_{DS} = 25V$ $f = 1\text{ MHz}$		13940		pF
C_{oss}	Output Capacitance			5200		
C_{rss}	Reverse Transfer Capacitance			229		
Q_g	Total Gate Charge ^④	$V_{GS} = 10V$ $V_{DD} = 300V$ $I_D = 94A @ 25^\circ C$		580		nC
Q_{gs}	Gate-Source Charge			72		
Q_{gd}	Gate-Drain ("Miller") Charge			234		
$t_{d(on)}$	Turn-on Delay Time	INDUCTIVE SWITCHING $V_{GS} = 15V$ $V_{DD} = 400V$ $I_D = 94A @ 25^\circ C$ $R_G = 4.3\Omega$		32		ns
t_r	Rise Time			59		
$t_{d(off)}$	Turn-off Delay Time			498		
t_f	Fall Time			167		
E_{on}	Turn-on Switching Energy ^⑤	INDUCTIVE SWITCHING @ 25°C $V_{DD} = 400V, V_{GS} = 15V$ $I_D = 94A, R_G = 4.3\Omega$		2684		μJ
E_{off}	Turn-off Switching Energy			4448		
E_{on}	Turn-on Switching Energy ^⑤	INDUCTIVE SWITCHING @ 125°C $V_{DD} = 400V, V_{GS} = 15V$ $I_D = 94A, R_G = 4.3\Omega$		3391		
E_{off}	Turn-off Switching Energy			5082		

SOURCE-DRAIN DIODE RATINGS AND CHARACTERISTICS

Symbol	Characteristic / Test Conditions	MIN	TYP	MAX	UNIT
I_s	Continuous Source Current (Body Diode)			94	Amps
I_{SM}	Pulsed Source Current ^② (Body Diode)			282	
V_{SD}	Diode Forward Voltage ^④ ($V_{GS} = 0V, I_s = -94A$)		0.9	1.2	Volts
t_{rr}	Reverse Recovery Time ($I_s = -94A, di/dt = 100A/\mu s$)	$T_j = 25^\circ C$		960	ns
				1271	
Q_{rr}	Reverse Recovery Charge ($I_s = -94A, di/dt = 100A/\mu s$)	$T_j = 25^\circ C$		31	μC
				43	
I_{RRM}	Peak Recovery Current ($I_s = -94A, di/dt = 100A/\mu s$)	$T_j = 25^\circ C$		58	Amps
				56	

THERMAL CHARACTERISTICS

Symbol	Characteristic	MIN	TYP	MAX	UNIT
$R_{\theta JC}$	Junction to Case			0.15	$^\circ C/W$
$R_{\theta JA}$	Junction to Ambient			31	

- ① Repetitive Rating: Pulse width limited by maximum junction temperature.
- ② Repetitive avalanche causes additional power losses that can be calculated as $P_{AV} = E_{AR} * f$. **Pulse width tp limited by Tj max.**
- ③ Pulse Test: Pulse width < 380 μs , Duty Cycle < 2%
- ④ See MIL-STD-750 Method 3471
- ⑤ Eon includes diode reverse recovery.
- ⑥ Maximum 125°C diode commutation speed = di/dt 600A/ μs

Microsemi reserves the right to change, without notice, the specifications and information contained herein.

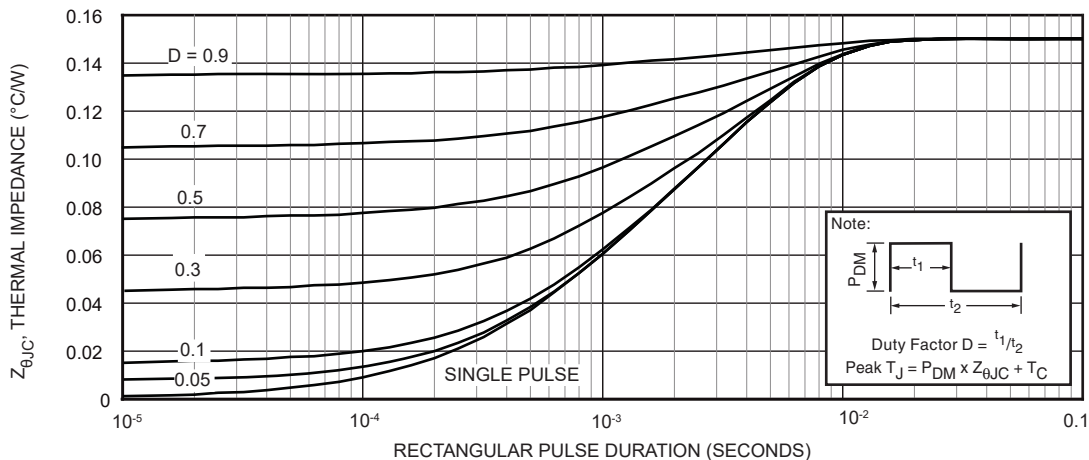

Figure 1, Maximum Effective Transient Thermal Impedance, Junction-To-Case vs Pulse Duration

Typical Performance Curves

APT94N65B2C3G

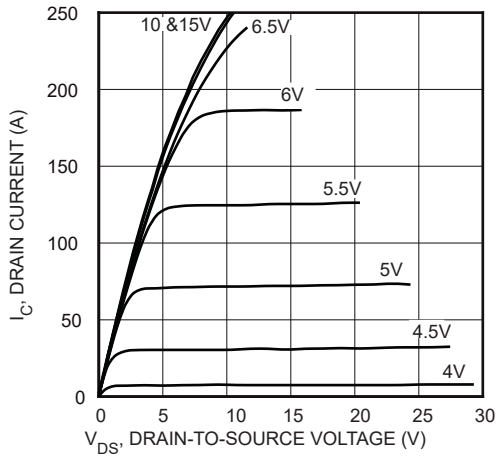

FIGURE 2, Low Voltage Output Characteristics

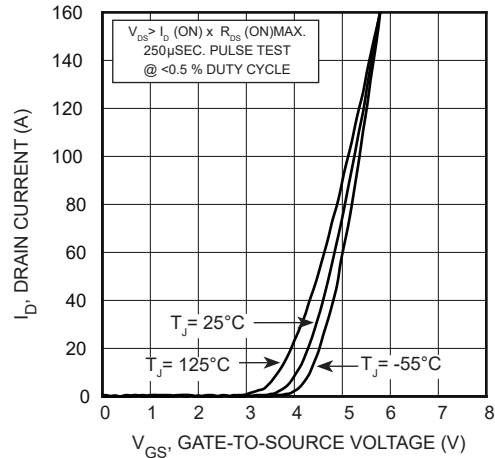

FIGURE 3, Transfer Characteristics

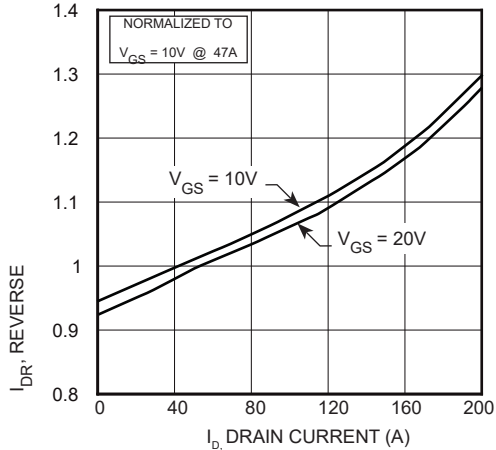

FIGURE 4, $R_{DS(ON)}$ vs Drain Current

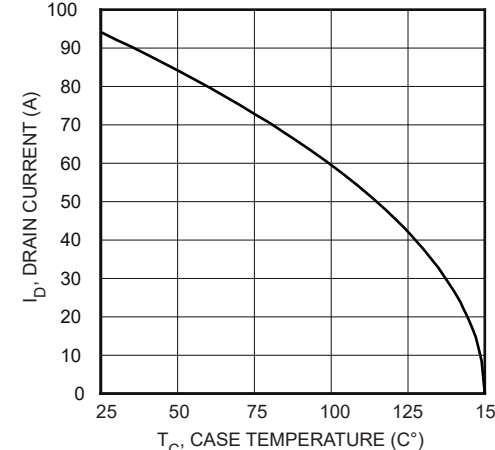

FIGURE 5, Maximum Drain Current vs Case Temperature

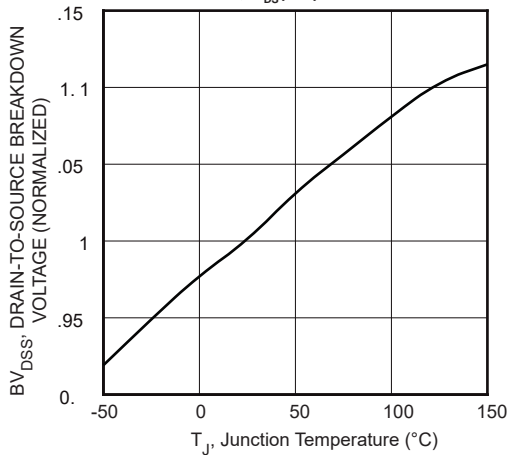

FIGURE 6, Breakdown Voltage vs Temperature

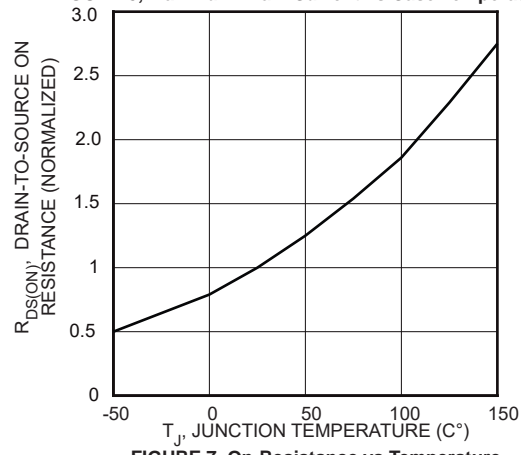

FIGURE 7, On-Resistance vs Temperature

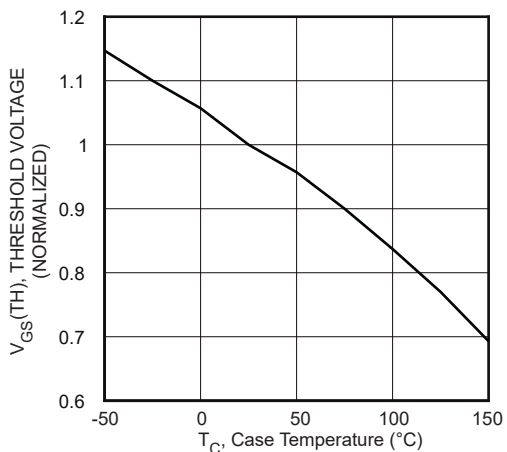

FIGURE 8, Threshold Voltage vs Temperature

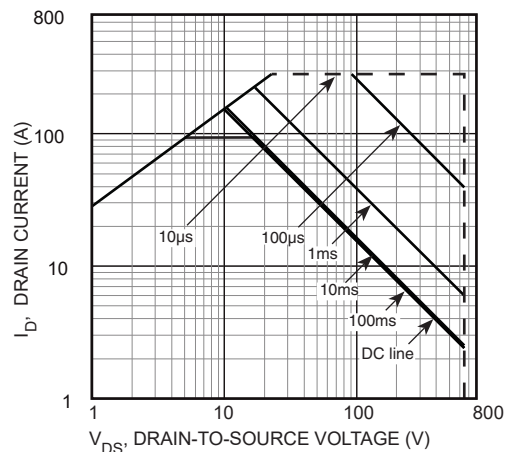

FIGURE 9, Maximum Safe Operating Area

Typical Performance Curves

APT94N65B2C3G

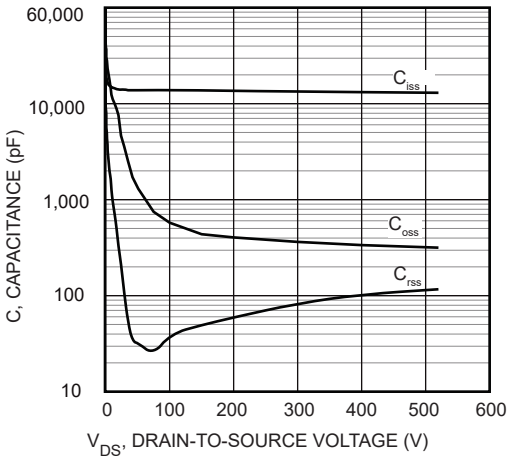

FIGURE 10, Capacitance vs Drain-To-Source Voltage

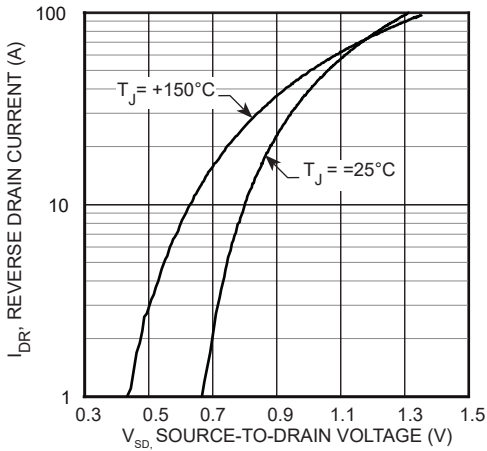

FIGURE 12, Source-Drain Diode Forward Voltage

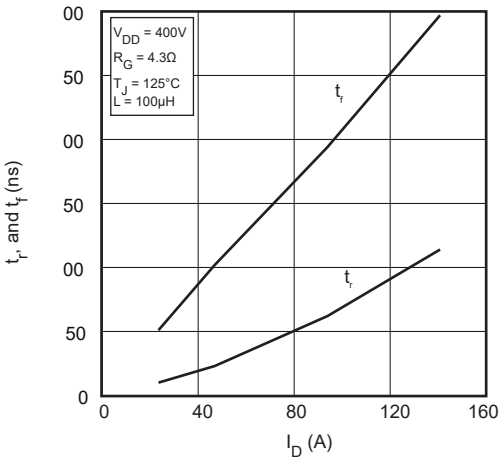

FIGURE 14, Rise and Fall Times vs Current

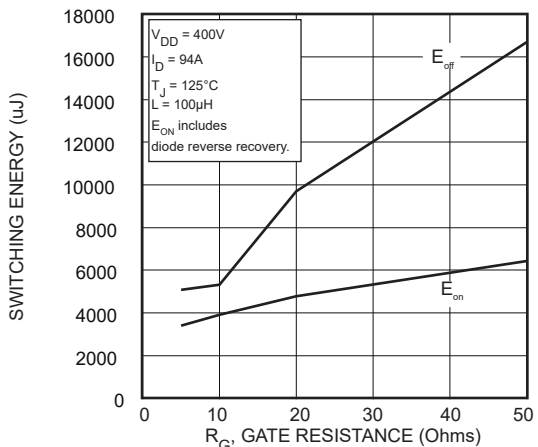

FIGURE 16, Switching Energy vs Gate Resistance

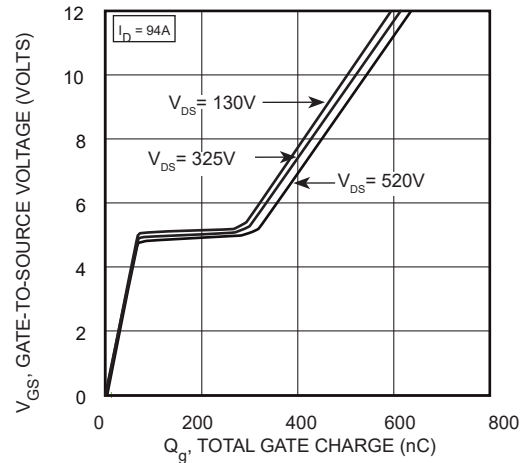

FIGURE 11, Gate Charges vs Gate-To-Source Voltage

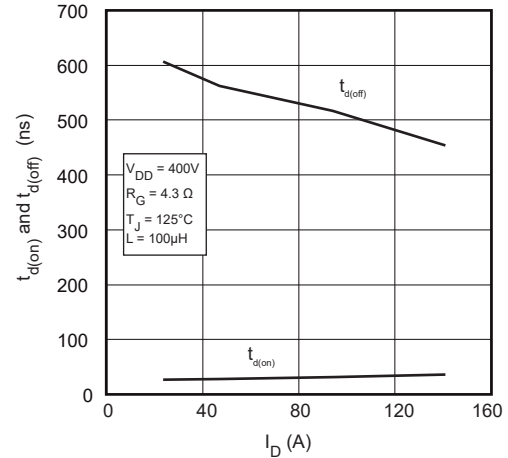

FIGURE 13, Delay Times vs Current

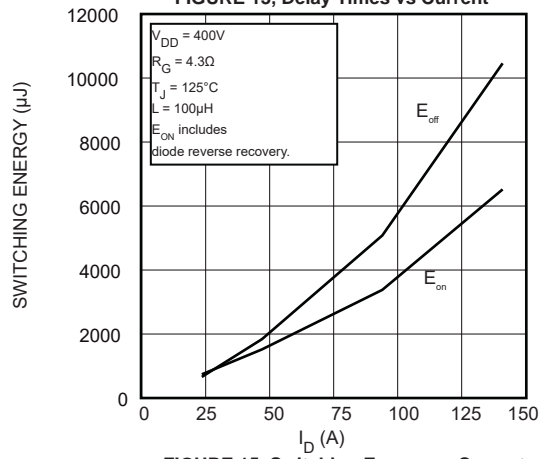

FIGURE 15, Switching Energy vs Current

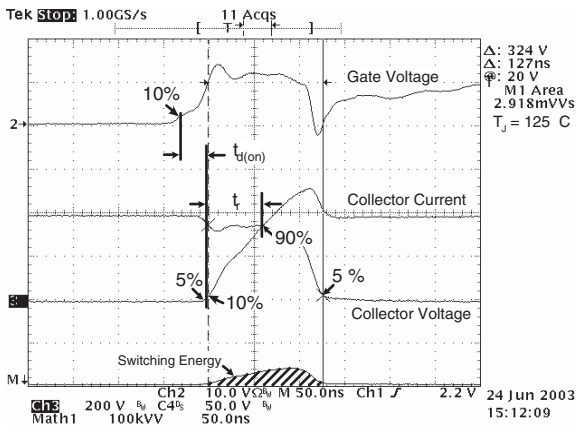

Figure 17, Turn-on Switching Waveforms and Definitions

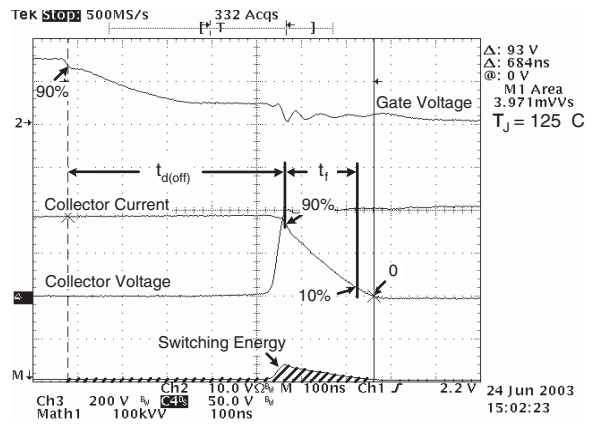

Figure 18, Turn-off Switching Waveforms and Definitions

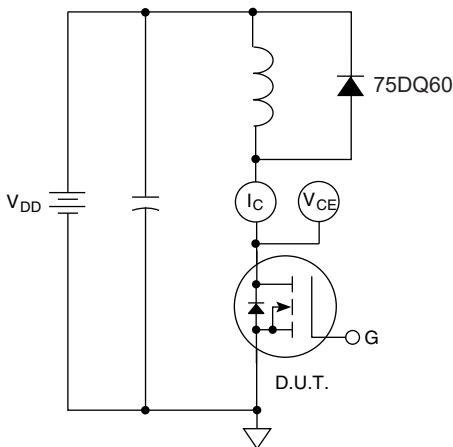
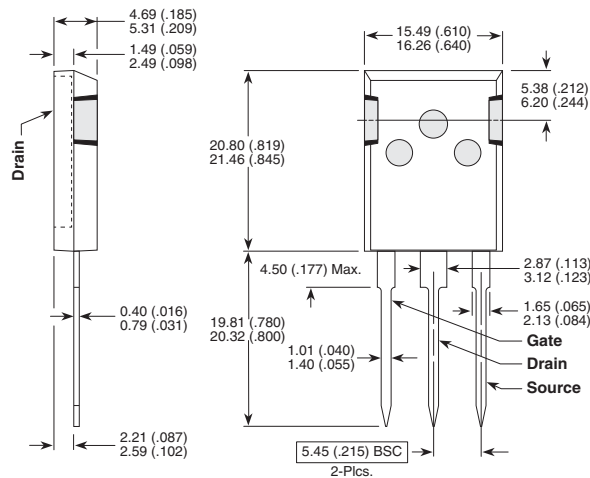

Figure 19, Inductive Switching Test Circuit

T-MAX® (B2) Package Outline

Ⓢ SAC: Tin, Silver, Copper



These dimensions are equal to the TO-247 without the mounting hole.

Dimensions in Millimeters and (Inches)