

Bluetooth Data Module Command Reference & Advanced Information User's Guide

MODULES:

RN24
RN25
RN41
RN42
RN41XV
RN42XV

SERIAL ADAPTERS:

RN220XP
RN240
RN270
RN274

© 2013 Roving Networks. All rights reserved.

RN-BT-DATA-UG Version 1.0r 3/26/13

Roving Networks, Inc.
102 Cooper Court
Los Gatos, CA 95032
+1 (408) 395-5300
www.rovingnetworks.com

Copyright © 2013 Roving Networks. All rights reserved. Apple Inc., iPhone, iPad, iTunes, Made for iPhone are registered trademarks of Apple Computer.

Roving Networks reserves the right to make corrections, modifications, and other changes to its products, documentation and services at any time. Customers should obtain the latest relevant information before placing orders and should verify that such information is current and complete.

Roving Networks assumes no liability for applications assistance or customer's product design. Customers are responsible for their products and applications that use Roving Networks components. To minimize customer product risks, customers should provide adequate design and operating safeguards.

Roving Networks products are not authorized for use in safety-critical applications (such as life support) where a failure of the Roving Networks product would reasonably be expected to cause severe personal injury or death, unless officers of the parties have executed an agreement specifically governing such use.

Table of Contents

Chapter 1. Introduction

1.1 Overview	5
1.2 Evaluation Boards & Reference Designs	5
1.3 Command Mode vs. Data Mode	6
1.4 Operating Modes	10
1.5 Using Dipswitches & GPIO Pins for Configuration	11
1.6 Making a Bluetooth Connection	12

Chapter 2. Command Reference

2.1 Command Syntax	19
2.2 SET Commands	19
2.3 GET Commands	31
2.4 Change & Action Commands	32
2.5 GPIO Commands	37

Chapter 3. Advanced Topics

3.1 Power Management	41
3.2 Configuration Timer Settings	44
3.3 Interfacing to a Microprocessor	45
3.4 HCI Mode	45
3.5 Profile Settings & Features	46
3.6 Using GPIO Pins as Modem Control Signals	47
3.7 Design Concerns	47
3.8 Serial Adapter Configuration	52
3.9 Null Modem & Flow Control Jumpers	53
3.10 Dipswitch Settings	54

Chapter 4. Applications

4.1 Instant Cable Replacement	57
-------------------------------------	----

Chapter 5. HID Profile

5.1 Overview	59
5.2 HID Firmware Overview	60
5.3 HID Reports	62
5.4 HID References	68

Appendix A. Factory Defaults

Appendix B. Command Quick Reference Guide

Appendix C. Firmware Revision History

C.1 Version 6.15 (3/26/2013)	75
C.2 Version 6.12 (Limited Release)	75
C.3 Version 6.11	75

C.4 Version 6.10	75
C.5 Version 4.77 (8/10/2009)	76
C.6 Version 4.74 (3/7/2009)	76

Appendix D. Document Information

Chapter 1. Introduction

1.1 OVERVIEW

This document contains the software command reference and advanced configuration settings for Roving Networks Bluetooth *data* modules. The document is applicable to all Bluetooth data modules (such as the RN41 and RN42), and USB dongles. Commands and settings that are specific to a single product or product family are identified as such in the document.

You configure Roving Networks Bluetooth devices over the Bluetooth link or over the module's UART using a simple ASCII command language. Set commands configure the module and get commands echo the current configuration. Configuration settings modified with set commands do not take effect until the module has been rebooted, even though the get command may show otherwise.

This document assumes that you have a working knowledge of Bluetooth operation and communications. To configure the Roving Networks modules you need a Bluetooth-enabled PC (either built-in or using a USB Bluetooth dongle). You can only configure one module at a time. Once configured, module settings are saved (independent of power down) until they are explicitly changed or the factory defaults are restored.

NOTICE TO CUSTOMERS

The commands and applications described in this document apply to Roving Networks Bluetooth *data* modules, e.g., RN41 and RN42. For Bluetooth audio module configuration information (e.g., RN52), refer to the *Bluetooth Audio Module Command Reference User's Guide*.

1.2 EVALUATION BOARDS & REFERENCE DESIGNS

Roving Networks provides a variety of boards, kits, and reference designs that you can use for evaluation and prototyping.

The RN-41-EK and RN-42-EK evaluation boards are field-ready, Bluetooth SIG qualified prototyping platforms for the RN41 and RN42 modules, respectively. The boards have the flexibility to connect directly to PCs via a standard USB interface (via the FTDI chipset) or to embedded processors through the TTL UART interface. The status LEDs, dipswitches, and signal headers enable demonstrations and proofs of concept.

The Bluetooth HID reference design is implemented in the RN42HID-I/RM module. The Bluetooth HID profile is typically used in applications such as keyboards, mice, and game controllers. To demonstrate the basic capability of the Bluetooth HID profile, Roving Networks has developed a Bluetooth reference design implemented in the RN42HID-I/RM module. The reference design operates in three modes:

- *Presenter mode*—Used for presentation software such as Microsoft Powerpoint
- *Music mode*—Music controller for products such as the iPod, iPhone, and iPad
- *Custom mode*—You can configure each button to send a sequence of up to 4 keys

For more information on available evaluation boards and reference designs, refer to the Roving Networks web site.

1.3 COMMAND MODE VS. DATA MODE

The Bluetooth module operates in two modes: data mode (default) and command mode. While in data mode, the module operates as a data pipe. When the module receives data, it strips the Bluetooth headers and trailers and passes the user data to the UART port. When data is written to the UART port, the module constructs the Bluetooth packet and sends it out over the Bluetooth wireless connection. Thus, the entire process of sending/receiving data to the host is transparent to the end microprocessor. See [Figure 1-1](#).

FIGURE 1-1: DATA & COMMAND MODES

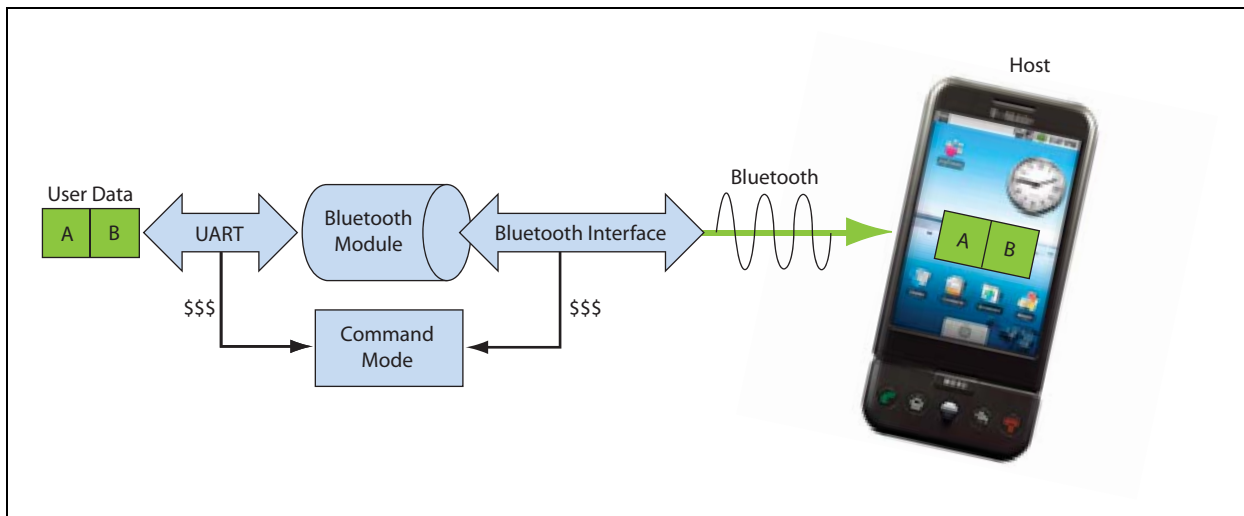

The default configuration for the Bluetooth module is:

- Bluetooth slave mode
- Bluetooth pin code 1234
- Serial port 115,200 Kbps baud rate, 8 bits, no parity, 1 stop bit
- Serial port flow control disabled
- Low power mode off

You configure the module by putting it into command mode (see [“Enter Command Mode” on page 8](#)) and sending ASCII commands over the UART port or the Bluetooth link. You reboot the module so that the settings take effect. Once you change the configuration parameters, they persist until you change them or you perform a factory reset.

There are two ways to configure the Bluetooth module:

- Local configuration using your computer’s serial port
- Via Bluetooth

You need a terminal emulator to complete the setup.

Note: Use either the TeraTerm (Windows OS) or CoolTerm (Mac OS-X) terminal emulator program.

1.3.1 Configuring the Module over the UART Port

Connect the module to your computer. You can connect using the RS-232 DB9 port or via a USB cable. For example, if you are using the RN-41-EK evaluation board, connect it to your computer using a USB cable.

With the Bluetooth module connected and powered on, run a terminal emulator and open the COM port to which the cable is connected. The terminal emulator's communication settings should be the default serial port settings:

- Baud rate 115,200 kbps
- 8 bits
- No parity
- 1 stop bit
- Hardware flow control enabled

Note: You can use local configuration at any time when the module does NOT have a Bluetooth connection, as well as under certain conditions. If the module is in configuration mode and a connection occurs, the module exits configuration mode and data passes back and forth from the remote module.

Once a connection is made, you can only enter command mode if the boot-up configuration timer has not expired (60 seconds). To remain in configuration mode, set the configuration timer to 255. See [“Configuration Timer Settings” on page 44](#) for more information.

Note: If the module is in Auto-Connect Master Mode, you cannot enter command mode when connected over Bluetooth. See [“Operating Modes” on page 10](#) for more information on the various operating modes.

Refer to [“Enter Command Mode” on page 8](#) for information on entering command mode from a terminal emulator.

1.3.2 Remote Configuration Using Bluetooth

It is often useful to configure the module remotely over a Bluetooth connection. Before performing remote configuration using Bluetooth, first pair the Bluetooth module with your computer. For PCs with Bluetooth capability and running Windows, click **Bluetooth devices** in the system tray at the bottom right of your computer screen. Select **Add a Bluetooth device** and follow the on-screen instructions. For Mac OS-X, click the Bluetooth icon, select **Set up Bluetooth device**, and follow the on-screen instructions.

Once a connection is made, you can only enter command mode if the boot-up configuration timer has not expired (60 seconds). To remain in configuration mode, set the configuration timer to 255. See [“Configuration Timer Settings” on page 44](#) for more information.

When you are finished configuring, reset the module or send the `---` command, which causes the module to exit configuration mode and allows data to pass normally.

Note: Configuration mode (local or remote) is NEVER enabled when the module is in auto-mode and is connected over Bluetooth.

1.3.3 Enter Command Mode

To enter command mode, launch a terminal emulator and specify the module's default settings. [Table 1-1](#) shows the serial port settings.

TABLE 1-1: SERIAL PORT SETTINGS

Setting	Value
Port	COM port to which you attached the module
Baud rate	115200
Data rate	8 bits
Parity	None
Stop bits	1
Flow control	None

Type `$$$` into the terminal emulator to enter command mode.

The module returns the string `CMD`, which indicates that your connection and terminal settings are correct. While in command mode, the module accepts ASCII bytes as commands. When you enter a valid command, the module returns `AOK`. It returns `ERR` for an invalid command and `?` for unrecognized commands. Type `h <cr>` to see a list of commands.

A quick check to confirm that you are in command mode is to type the `x <cr>` command after entering command mode. This command shows the a summary of the module's current settings, such as the Bluetooth name, device class, and serial port settings. See [Figure 1-2](#).

To return to data mode, type `---` `<cr>` or reset the module and re-connect.

Note: The module supports a fast data mode. In this mode, the module does not go into command mode even if it receives `$$$`. If you do not enter command mode within the configuration window (60 seconds), the module enters fast data mode. See "[ST,<value>](#)" on [page 26](#) and "[Configuration Timer Settings](#)" on [page 44](#) for more information on setting the configuration window.

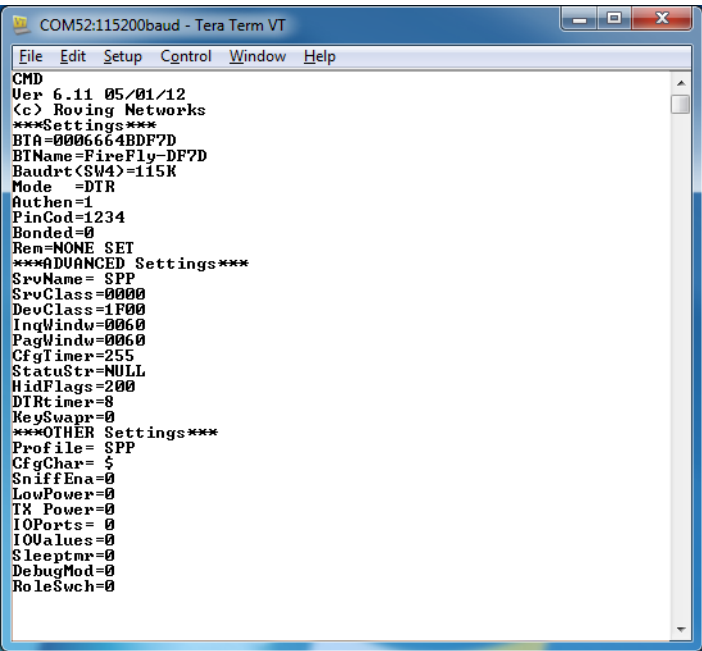
FIGURE 1-2: VIEW CURRENT SETTINGS

```

COM52:115200baud - Tera Term VT
File Edit Setup Control Window Help
CMD
Ver 6.11 05/01/12
(c) Roving Networks
***Settings***
BTName=FireFly-DF7D
Baudrt(SW4)=115K
Mode =DTR
Authen=1
PinCod=1234
Bonded=0
Rem=NONE SET
***ADVANCED Settings***
SrvName= SPP
SrvClass=0000
DevClass=1F00
InqWindw=0060
PagWindw=0060
CfgTimer=255
StatuStr=NULL
HidFlags=200
DTRTimer=0
KeySwpr=0
***OTHER Settings***
Profile= SPP
CfgChar= $
SniffEna=0
LowPower=0
TX Power=0
IOPorts= 0
IOValues=0
Sleeptr=0
DebugMod=0
RoleSwch=0
    
```

1.4 OPERATING MODES

The Bluetooth module has several operating modes, which you set using the `SM` command in command mode.

Note: In all master modes, the module cannot be discovered or configured remotely over Bluetooth.

- *Slave Mode (SM,0)*—Default mode, in which other Bluetooth devices can discover and connect to the module. You can also make outbound connections in this mode.
- *Master Mode (SM,1)*—In this low-speed connection mode, the module makes connections when a connect command (`c`) is received. This command can also contain the Bluetooth address of the remote device. If a device is not specified, the module uses the stored remote address. The connection can be broken if the special break character or string is sent (use the `SO` command to set the break character). This mode is useful when you want the module to initiate connections (not receive them). In this mode, the module is NOT discoverable or connectable.
- *Trigger Mode (SM,2)*—In this low-speed connection mode, the module makes connections automatically when a character is received on the serial port (UART). The connection continues as long as characters are received on either end. The module has a configurable timeout (which you set using the `ST` command) that disconnects the module after the specified number of seconds of inactivity (1 to 255) or a configurable break character is received.
- *Auto-Connect Master Mode (SM,3)*—In this mode, the module makes connections automatically on power-up and re-connects when the connection is lost. This mode can be set by command, or by setting the external dipswitch 3 during power up (evaluation kits) or by driving GPIO6 high (Bluetooth modules). If an address is not stored, the module performs an inquiry process and the first device found that matches the COD is stored. In this mode, high-speed data is passed without being interpreted; therefore, the connection cannot be broken via commands or software break characters. If a disconnect occurs, the module attempts to re-connect until successful.
- *Auto-Connect DTR Mode (SM,4)*—This mode must be set by command. It operates like Auto-Connect Master Mode, except that you control connection and disconnection with dipswitch 3 (evaluation kits) and GPIO6 (Bluetooth modules). Turning the dipswitch on or driving GPIO6 high initiates the auto-connect process; turning the dipswitch off or driving GPIO6 low causes a disconnect.
- *Auto-Connect ANY Mode (SM,5)*—This mode must be set by command. This mode operates like Auto-Connect DTR Mode, except that each time the dipswitch or GPIO is set, an inquiry is performed and the first device found is connected. The stored address is NOT used, and the address found is never stored.
- *Pairing Mode (SM,6)*—In this mode, the module attempts to connect with the remote device matching the store remote address. You set the remote address using the `SR` command.

1.5 USING DIPSWITCHES & GPIO PINS FOR CONFIGURATION

The Bluetooth modules have dipswitches (for evaluation kits) or GPIO pins (for modules) that you can use to configure the module. See [Table 1-2](#).

TABLE 1-2: DIPSWITCH & GPIO SETTINGS

Function	Dipswitch (Adapters & Evaluation Boards)	GPIO Pin (Modules)	Settings (OFF = 0 VDC/ON = 3 VDC)
Factory Reset	1	GPIO4	Off = disabled, on = armed. Set this dipswitch/GPIO pin on power up to arm the reset function. Then toggle the module off and on three times to reset all settings to the factory defaults (other than the Bluetooth name).
Auto Discovery/Pairing	2	GPIO3	Off = disabled, on = enabled. You use these settings in conjunction with dipswitch 3/GPIO6. If dipswitch 3/GPIO6 are also set, the module performs a device inquiry scan, searching for a partner device with a special matching class (0x55AA). Once it finds this device, it stores the address into the remote address field and auto-connects to the remote device. If dipswitch 3/GPIO6 are NOT set, the module enters slave mode with the special matching class and waits for the master to find it. This mode is usually set once on both ends of a module pair (for instant cable replacement) and then removed.
Auto-Connect	3	GPIO6	Off = disabled, on = enabled. This setting is equivalent to Auto-Connect Master Mode in software. The module connects to the stored address. If dipswitch 2/GPIO3 is also set, a new discovery/pairing can be made. If connected via the CFR command, toggling the dipswitch off-on-off terminates the current connection.
Baud Rate	4	GPIO7	Off = stored setting (115 K), on = 9,600. This setting is used to configure 9,600 or a software selected (default = 115 K) baud rate. If the dipswitch is off, the module uses the stored baud rate setting. When the dipswitch is on, the baud rate is set to 9,600 regardless of the software setting.

Table 1-3 describes the GPIO pin assignments for Roving Networks Bluetooth hardware. Refer to “GPIO Commands” on page 37 for more information on the commands you use to configure the GPIO pins.

TABLE 1-3: GPIO ASSIGNMENTS

GPIO	RN4x, RN4xXV, RN220, RN270, RN-XV-EK, RN-XV-RD1/2	RN-4X-EK	RN-BT-HID-RD1
Firmware	4.77	6.xx	6.11-HID DEMO
GPIO2	–	–	IN: (B7) power on/off, left arrow, iOS keyboard toggle
GPIO3	IN: (dipswitch 2), discovery/auto-pair read at power up, DCD in DUN and MDM profile	–	IN: (B3) Custom, down arrow
GPIO4	IN: (dipswitch 1), factory default	IN: (dipswitch 1), factory default	IN: presentation (B1)
GPIO5	OUT: system status (green LED)	OUT: system status (green LED)	OUT: system status (green LED)
GPIO6	IN: (dipswitch 3), auto connect read at power up, DSR in DUN and MDM profile	–	IN: factory reset (B4)
GPIO7	IN: (dipswitch 4), baud rate select on power up, CTS in DUN and MDM profile	–	IN: (B3), music
GPIO8	–	OUT: over the air TX activity (blue LED)	–
GPIO9	OUT: fire relay A on RD1	–	–
GPIO10	–	–	IN: pull high connect to stored Bluetooth address; pull low disconnect if connected OUT: (B6), SPP, FAST-FWD
GPIO11	–	–	IN: on power up if high, HID profile is selected AND if bit 9 in HID flag is set (SH, <value>)

1.6 MAKING A BLUETOOTH CONNECTION

By default, the Bluetooth module acts as a slave and the PC or smartphone is the master. You connect to the Bluetooth module using the Bluetooth device manager, which varies depending on your smartphone or computer’s operating system. In all cases, the process is the same:

- *Discovery*—In the discovery phase, the Bluetooth module broadcasts its name, profile support, and MAC address. It is ready for other devices to pair with it. Discovery is only available in slave mode.
- *Pairing*—During pairing, the Bluetooth module and the Bluetooth master validate the pin code. If the pin code validates successfully, they exchange security keys and a channel hopping pseudo-random sequence. Successful pairing results in the module and master establishing link keys.
- *Connecting*—Before connecting, the Bluetooth devices must have paired successfully. The master initiates a connection, the master and slave validate the link keys, and a Bluetooth link is established.

The following sections describe these processes in detail.

1.6.1 Discovery

When you turn on the Bluetooth module, it is discoverable. For evaluation kits, the green LED blinks, indicating that it is discoverable. Open your PC's Bluetooth device manager and choose to add a new device. The Bluetooth device manager's icon is located in the bottom right corner of your screen in the taskbar for Windows and in the upper right corner for Mac OS-X. The Bluetooth device manager displays a list of discoverable Bluetooth devices (see [Figure 1-3](#)). The Bluetooth module displays as Serial Port Profile (SPP) Service **FireFly-ABCD**, where **FireFly** is the type of Roving Networks module and **ABCD** is the last four nibbles of the Bluetooth MAC address. (You can change the local device name).

FIGURE 1-3: DISCOVER THE BLUETOOTH MODULE

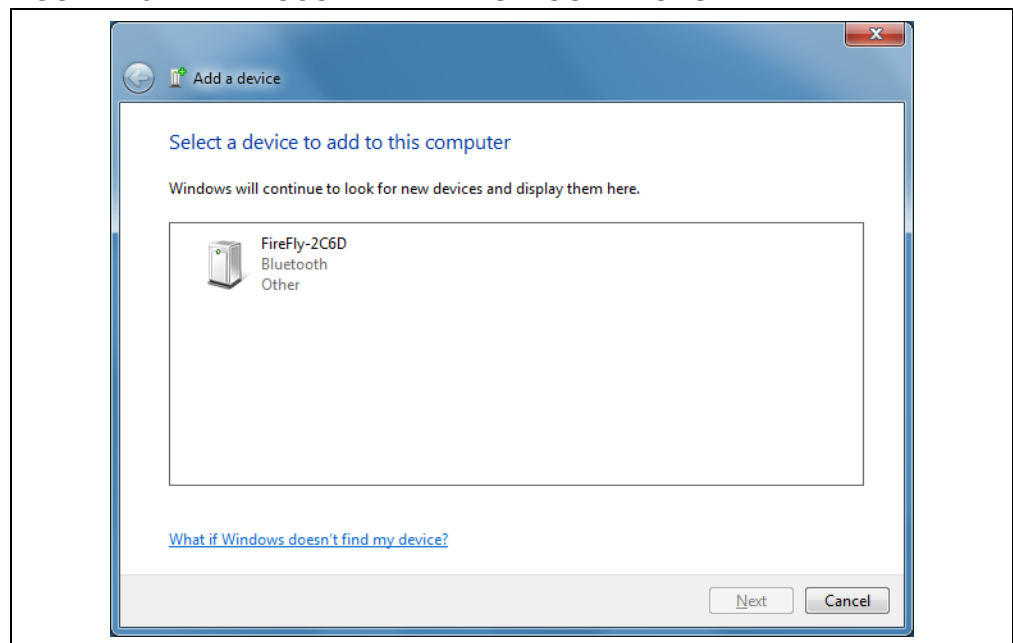

1.6.2 Pairing

To pair with the module, double-click the module's name (i.e., **FireFly-XXXX**) in the list. The firmware automatically stores up to 8 pairings from remote hosts in a first in, first out fashion.

Choose to enter the module's pairing code (see [Figure 1-4](#)) and enter the default pin code, 1234. When the Bluetooth device manager completes pairing, it issues a message that the Bluetooth device is installed on COMX where COMX is unique to your computer. In some cases, the Bluetooth device manager creates two COM ports; in this situation, only use the COM port labeled "outgoing."

FIGURE 1-4: PAIR WITH THE BLUETOOTH MODULE

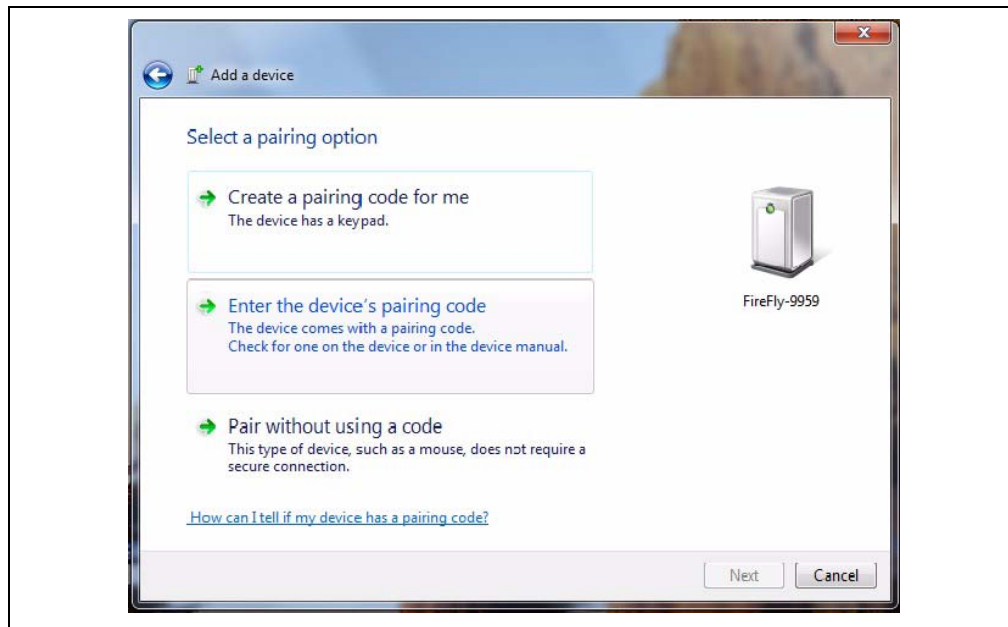

Note: You only need to pair with the module once.

Figure 1-5 shows example COM port settings.

FIGURE 1-5: BLUETOOTH COM PORT SETTINGS

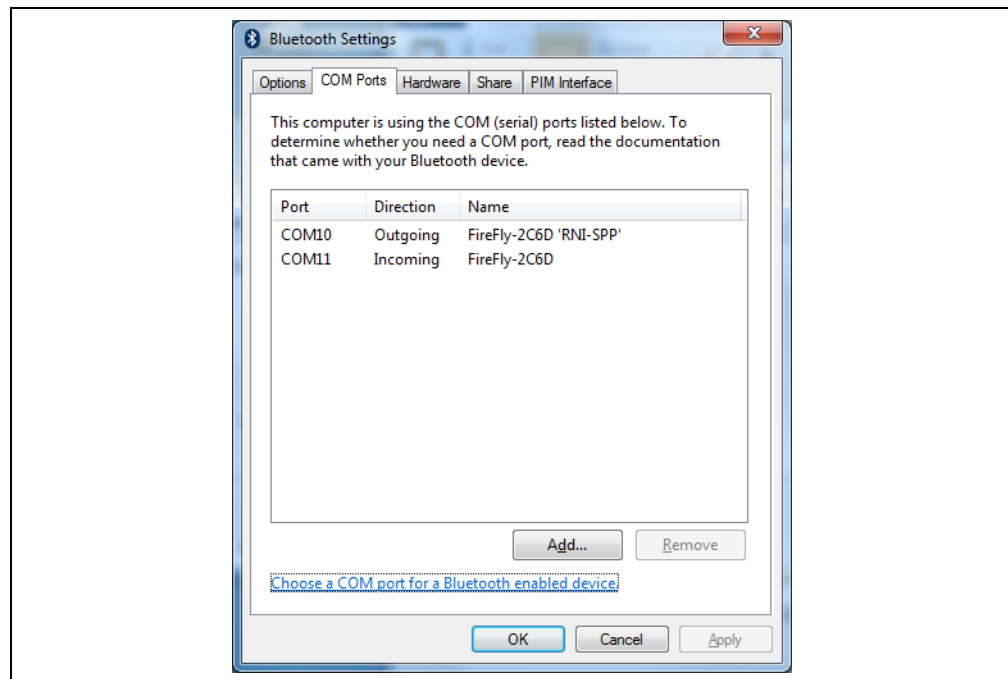

If the remote Bluetooth device does not require authentication, a connection can occur without the pairing process. However the Bluetooth specification requires that if either device involved in the pairing process requires authentication, the other device must participate to ensure a secure link. Roving Networks modules default to an open mode, such that the module does NOT require authentication. However, most PCs require authentication. See “[Security Modes](#)” on page 17 for more information on using pass keys.

Once connected, the module is in data mode allowing data to flow in both directions as if the serial port were locally attached to the PC. For configuration, the module must be in command mode. See “[Enter Command Mode](#)” on page 8 for more information.

Note: Only one client can connect to a slave module at a time. As a master, the module can make multiple connections, but only in a point-to-point, serialized fashion. Roving Networks modules do not currently support multi-point master mode.

1.6.2.1 PAIRING WITH A COMPUTER OR SMART PHONE

The module may use simple secure pairing (SSP) if it is attempting to pair with devices that support the Bluetooth specification version 2.1 + EDR. SSP does not require the user to remember the pin code, but it asks to confirm the 6-digit number if the device has a display capability.

1.6.3 Connecting

In most cases, you connect from another device to the module as an outgoing Bluetooth connection. You can also make an incoming connection in which the evaluation board initiates the connection to the remote device.

1.0.0.1 Outgoing Connections

To establish an outgoing Bluetooth connection from a PC to the module, open the module’s outgoing COM port from your application or a terminal emulator. The module remains connected until you close the COM port or remove power from the board.

Once connected, the module is in data mode allowing data to flow in both directions. For configuration, the module must be in command mode. See “[Enter Command Mode](#)” on page 8 for more information.

Note: Only one client can connect to a slave module at a time. As a master, the module can make multiple connections, but only in a point-to-point, serialized fashion. Roving Networks modules do not currently support multi-point master mode.

1.0.0.2 Incoming Connections

For an incoming connection you use the port specified in your Bluetooth settings as incoming (refer back to [Figure 1-3](#)). In incoming connections, the PC or host listens for an incoming connection from the remote Bluetooth device, in this case the module. Perform the following steps to make in incoming connection.

1. You need the MAC address of the PC’s Bluetooth radio to connect from the module to the host PC. Open the PC’s Bluetooth advanced settings to find the MAC address. See [Figure 1-6](#).

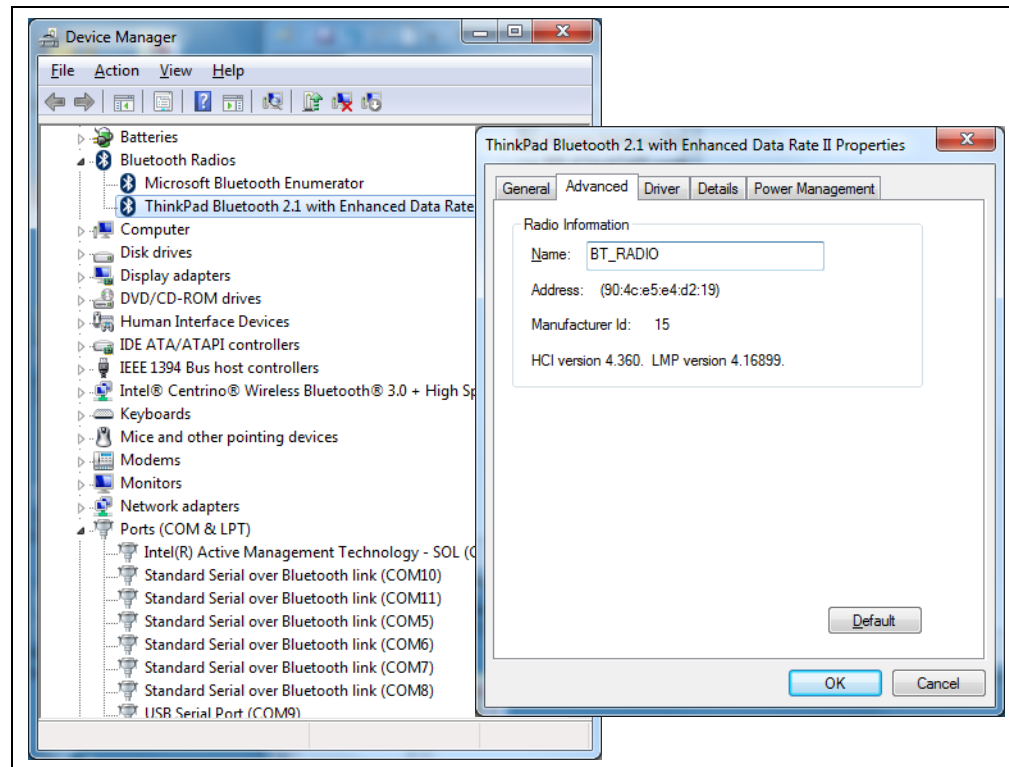
FIGURE 1-6: PC'S BLUETOOTH RADIO MAC ADDRESS

2. Pair your module with the PC as described in [“Pairing”](#) on page 13.
3. Open a terminal (called terminal A in this example) and connect it to the module. You can run this terminal on the host PC or another computer.
4. Open a second terminal (called terminal B in this example) on the host PC to listen for the incoming Bluetooth connection using the incoming COM port number.
5. Type `C, <MAC address> <cr>` in terminal A to establish an SPP connection to the host PC. See [Figure 1-7](#) for an example connection.
6. Try the following commands:

- `$$$` to enter command mode
- `SO, %` to enable status message to see connect/disconnect conditions
- `R, 1` to reboot
- `$$$` to re-enter command mode
- `+` to enable local echo
- `C, <MAC address>` to attempt a connection with remote device

Characters you type in terminal B are sent over Bluetooth to the host PC and appear in terminal A. Any characters entered in terminal A are transmitted to terminal B.

7. To kill the connection, type the `k, 1 <cr>` command in terminal B.

FIGURE 1-7: TERMINALS A & B

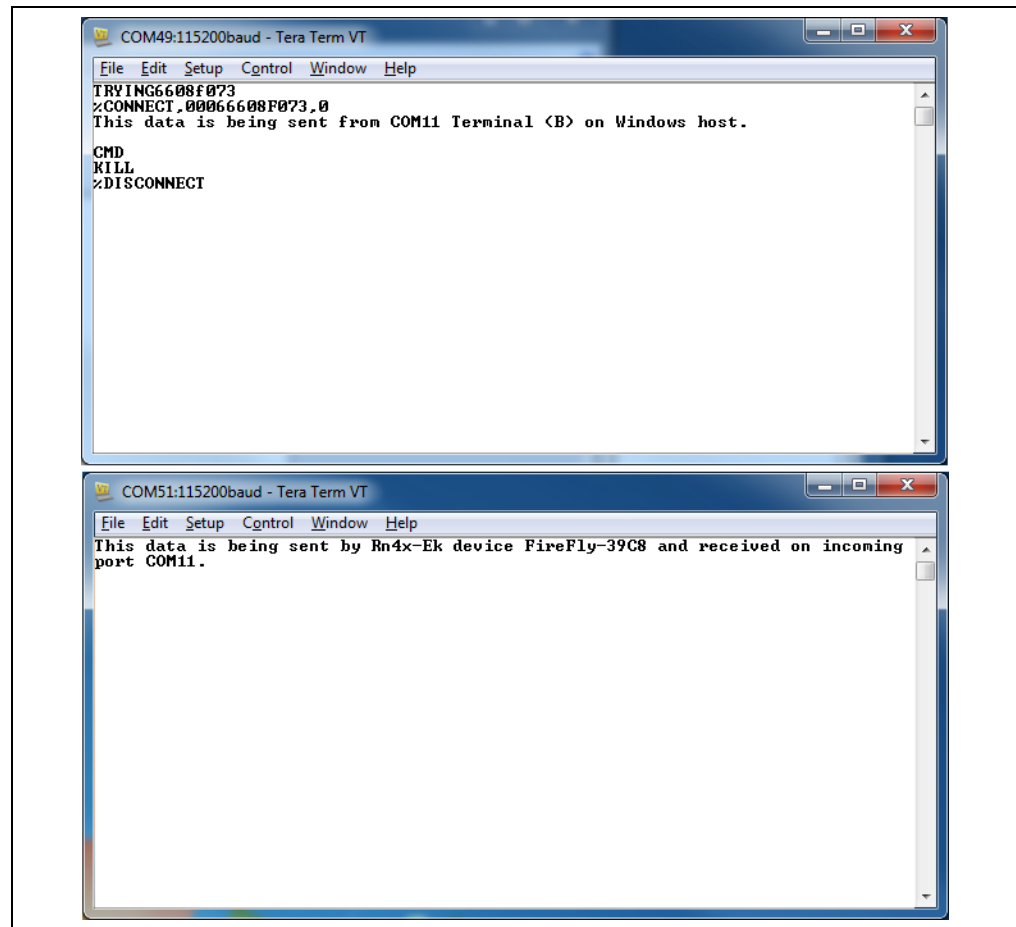

1.6.4 Security Modes

The Bluetooth module supports authentication. If the local or remote Bluetooth device has authentication enabled, a pin code is required the first time a connection is attempted. The pin code is a series of numbers or characters from 1 to 16 characters in length.

Note: The default pin code for Roving Networks Bluetooth modules is **1234**. The RN-41-EK and RN-42-EK evaluation boards do not require a pin code.

After you enter the pin code, the Bluetooth devices compare them. If they match, a link key is generated and stored. Usually, but not always, the remote device stores the link key. For subsequent connections, the devices compare link keys. If they are correct, you do not need to re-enter the pin code.

If the remote device is a PC or PDA, the user generally is prompted to enter this pin code. To remove the stored link key on the remote device, you typically “unpair” or remove the device from the Bluetooth manager. You can change the pin code to remove the link key on the Bluetooth module, forcing a new pin code exchange to occur upon subsequent connection attempts.

Note: Only one master can connect to the Bluetooth module at a time.

Chapter 2. Command Reference

Roving Networks Bluetooth modules support a variety of commands for configuration. This section describes these commands in detail and provides examples.

2.1 COMMAND SYNTAX

To issue commands to the module, you send a keyword followed by optional parameters.

- All commands are one or two characters and can be upper or lower case.
- Delimit command arguments with a comma.
- Commands use decimal input, except where noted.
- Text data, such as the Bluetooth name and pin code, is case sensitive.
- All commands only take effect AFTER reboot, except where noted.

There are five general command categories, as shown in [Table 2-1](#).

TABLE 2-1: COMMAND TYPES

Command Type	Description
Set commands	Store information to flash memory. Changes take effect after a power cycle or reboot.
Get commands	Retrieve and display the stored information.
Change commands	Temporarily change the value of various settings such as serial baud rate, parity, etc.
Action commands	Perform actions such as inquiries, connecting, etc.
GPIO commands	Configure and manipulate the GPIO signals.

2.2 SET COMMANDS

The set commands specify configuration settings and take effect after power cycling or rebooting.

2.2.1 S7,<flag>

This command enables/disables 7-bit data mode, where <flag> is shown in [Table 2-2](#).

TABLE 2-2: 7-BIT DATA MODE VALUES

Flag	Description
0	Disable.
1	Enable.

Default: 0

Example: `S7,1` // Enable 7-bit data mode

2.2.2 SA,<value>

The set authentication command forces authentication when a remote device attempts to connect, where <value> is one of the values shown in [Table 2-3](#). Regardless of this setting, if a remote device forces authentication, this device responds with the stored

pin code. Once a remote device has exchanged pin codes with this device, a link key is stored for future use. The device stores up to 8 keys automatically and permanently in flash memory, in a first in, first out fashion.

TABLE 2-3: SET AUTHENTICATION VALUES

Value	Description
0	Open mode. With this mode, the module uses Bluetooth version 2.0 with NO encryption (open mode). This mode is useful for legacy devices that do not need security. This mode is the same as in firmware version 4.77.
1	SSP keyboard I/O mode (default). If this option is set, the remote host receives a prompt; reply yes to pair. For Android devices, the user is prompted with a 6-digit code and is asked to verify that the code matches on the module. The module always responds yes. Because the module cannot display a code, simply press OK or Yes on the remote device to authenticate.
2	SSP "just works" mode. This mode works with iOS device and newer PCs. You can use this mode with Droid devices if the application connects using unsecure mode (which was the default on Droid version 3.3). This mode also works with new PC stacks.
4	Pin code. Forces pin code mode authentication (Bluetooth version 2.0), which requires the host device to enter a pin code that matches the stored pin code. The functionality is similar to firmware version 4.77.

Note: Modes 0 and 4 are legacy modes that do not support SSP (Bluetooth version 2.0).

Default: 1

Example: SA, 1 // Enable authentication

2.2.3 SB,<value>

When you issue the set break command, the device sends a break signal immediately where <value> is the length of the break signal in milliseconds as shown in [Table 2-4](#). The break signal on the UART TX pulls the line low.

TABLE 2-4: SET BREAK VALUES

Value	Break Length (ms)
1	37
2	18.5
3	12
4	9
5	7
6	6

Default: N/A

Example: SB, 1 // Send a break signal of 37 ms

2.2.4 SC,<value>

This command sets the service class field in the class of device (COD). The service class consists of the most significant 11 bits in the COD. This command sets the MSW to create the 24-bit device class number. The inquiring device interprets the service class to determine the service. A complete listing of available Bluetooth service classes is referenced on the Bluetooth SIG web site.

Default: 0000

Example: `SC,0002` // Set service class to 0002

2.2.5 SD,<value>

This command sets the class of device (COD) LSW. The COD is a 24-bit number that is made up of the device class with major 8 bit and minor in a 16-bit word. This command is used with the service class command.

Default: 1F00

Example: `SD,8040`

To set the COD to 0x1F0123, use the following commands:

```
SC,001F
SD,0123
```

2.2.6 SE,<value>

In firmware versions 5.40, 6.10, and above, this command sets the UUID for outbound connections. Roving Networks bluetooth modules use the standard SPP UUID of 0x1101. Encryption is always enabled in firmware versions 5.40 and higher.

2.2.6.1 FIRMWARE VERSION 5.40 & HIGHER

The UUID setting is useful for Android-based applications so that the application can uniquely determine the remote device. Android applications require a 128-bit UUID. 00001101-0000-1000-8000-00805F9B34FB is the 16-bit UMUID for the serial port profile (0x1101) when promoted to a 128-bit UUID. Android application developers are expected to use this 128-bit UUID for SPP.

This feature applies to SPP connect back only, which is used primarily for Android devices. With this feature, you can set a custom UUID for connecting back. Android phones run an audio gateway that always attempts to grab a connection when it comes in from a remote Bluetooth device such as the Roving Networks module. With the `SE` command, you can register a custom UUID, which ensures that ONLY your application obtains the connection when it comes in.

The default SSP UUID is 35111C0000110100001000800000805F9B34FB.

You can modify a subset of the UUID; the bytes are changed from left to right. For example, if the UUID is:

```
35111C0000110100001000800000805F9B34FB
```

Typing the command `SE,ABCD<cr>` changes the first 2 bytes resulting in:

```
ABCD1C0000110100001000800000805F9B34FB
```

The command has three short forms:

```
SE,S // Loads the default SPP UUID
```

```
SE,I // Loads the iPhone UUID
```

```
SE,C // Loads the custom UUID (appropriate for testing or custom use)
```

```
spp_uuid[19] =
```

```
{0x35,0x11,0x1C,0x00,0x00,0x11,0x01,0x00,0x00,0x10,0x00,0x80,0x00,0x00,0x80,0x5F,0x9B,0x34,0xFB};
```

2.2.9 **SI,<hex value>**

The inquiry scan window command sets the length of time the device spends enabling an inquiry scan (discoverability). The minimum value is 0x0012, corresponding to about a 1% duty cycle.

The page scan interval is fixed at 0x1000. The default window is 0x0100. The maximum value is 0x800. Set this parameter to 0x0000 to disable inquiry scanning and render the device undiscoverable. If the host has already paired, the inquiry scan is not used.

Note: When pairing with Android devices, increasing this value makes pairing more reliable.

Default: 0100

Example: `SI,0200` // Set inquiry scan window to 0x0200

2.2.10 **SJ,<hex value>**

The page scan window command sets the amount of time the device spends enabling page scanning (connectability). The minimum value is 0x0012, which corresponds to about a 1% duty cycle. The page scan interval is fixed at 0x1000. The default window is 0x0100. The maximum value is 0x800. Set this option to 0x0000 to disable page scanning and render the device non-connectable.

Note: When pairing with Android devices, increasing this value makes pairing more reliable.

Default: 0100

Example: `SJ,0200` // Set the page scan window to 0x0200

2.2.11 **SL,<char>**

This command sets the UART parity, where <char> is a character shown in [Table 2-7](#).

TABLE 2-7: UART PARITY VALUES

Value	Description
E	Even.
O	Odd.
N	None.

Default: N

Example: `SL,E` // Set parity to even

2.2.12 SM,<value>

This command sets the mode, where <value> is a decimal number as shown in [Table 2-8](#).

TABLE 2-8: MODE VALUES

Value	Description
0	Slave Mode.
1	Master Mode.
2	Trigger Mode.
3	Auto-Connect Master Mode.
4	Auto-Connect DTR Mode.
5	Auto-Connect Any Mode.
6	Pairing Mode.

Default: 04

Example: `SM,0` // Set the mode to slave

2.2.13 SN,<string>

This command sets the device name, where <string> is up to 20 alphanumeric characters.

Default: N/A

Example: `SN,MyDevice` // Set the device name to “MyDevice”

2.2.14 SO,<string>

This command sets the extended status string, where <string> is up to 8 alphanumeric characters. Setting this string to from 1 to 8 characters permits status messages to be sent to the local serial port. When you set this parameter, two status messages are sent:

- When a Bluetooth connection is established, the device sends the string <string>CONNECT.
- When disconnecting, the device sends the string <string>DISCONNECT.

This parameter is useful when connecting to equipment or hardware. For example, when the device is connected to a printer, the printer can examine an escape sequence. If <string> is set to ESC%, the printer can parse ESC%CONNECT and ESC%DISCONNECT messages without interfering with normal print jobs. In trigger or master modes, the first character of this string is used as the break connection character.

Default: Disabled

Example: `SO,ESC%` // Set escape sequence
`SO,<space>` // Disables the extended status string

2.2.15 SP,<string>

This command sets the security pin code, where <string> is up to 20 alphanumeric characters. Each time the device pairs successfully, it saves the Bluetooth address. The device can store up to eight addresses on a first in first out basis. Using this command also erases all stored pairings. You can use the same value that is already set. You cannot erase the pin code, however, you can overwrite the default pin code.

Default: 1234

Example: `SP,0123` // Set pin code to "0123"

2.2.16 SQ,<mask>

This command is for special configuration settings, where <mask> is a decimal number as shown in [Table 2-9](#).

TABLE 2-9: SPECIAL CONFIGURATION SETTINGS VALUES

Mask	Description
0	Default. The device does not use any special configuration.
4	With this option set, the device does not read the GPIO3 and GPIO6 pin values on power-up. This command is used when configuring GPIO3 and GPIO6 for a function other than the default configuration. See "GPIO Commands" on page 37.
8	Disables discoverability at power up. Clear this setting with <code>SQ,0</code> . Use the <code>w</code> or <code>Q,1</code> commands to enable discovery at runtime.
16	This option configures the firmware to optimize for low latency data transfers rather than throughput.
128	This option causes the device to reboot after disconnect.
256	This option sets 2 stop bit mode on the UART.

Note: If the module is unable to connect to the Bluetooth device for 15 to 30 seconds after disconnecting, try clearing the `SQ`, bit (i.e., use `SQ,0`).

Default: 0 // Do not use special configuration

Example: `SQ,128` // Reboot after disconnect

2.2.17 SR,<hex value>

This command stores the remote address, where <hex value> is 12 hexadecimal digits (6 bytes) with no spaces or characters between digits. Additionally, this command takes two special characters for the address parameter:

- `SR,Z` erases any stored addresses.
- `SR,I` writes the last address observed using the inquiry command. This command can be helpful when you only have one other device in range.

Note: In firmware version 6.12, you must type the `SR,Z` command in uppercase characters. If you type the command in lowercase characters, the module returns `ERR`.

Default: N/A

Example: `SR,00A053112233` // Set the remote Bluetooth address to
// 00A053112233

2.2.18 SS,<string>

This command sets the service name, where <string> is from 1 to 20 alphanumeric characters. This command is not supported in firmware version 6.x.

Default: SPP

Example: `SS,SerialPort` // Service name set to "SerialPort"

2.2.19 ST,<value>

This command sets the remote configuration timer, where <value> is a decimal number from 0 to 255 representing the time window (in seconds) to allow remote configuration over Bluetooth after power up in Slave Mode. In all Master modes, the remote configuration timer is set to 0 (no remote configuration). In Trigger Master Mode, the configuration timer is used as an idle timer to break the connection after time expires with no characters received.

The module supports a fast data mode. In this mode, the module does not go into command mode even if it receives \$\$\$\$. If you do not enter command mode within the configuration window set by the configuration timer, the module enters fast data mode.

This command has the special modes shown in [Table 2-10](#).

TABLE 2-10: CONFIGURAION TIMER SETTINGS

Value (Decimal)	Description
0	No remote configuration. No local configuration when connected.
1 - 252	Time in seconds from power up to allow configuration.
253	Continous configuration, local only.
254	Continous configuration, remote only.
255	Continous configuration, local and remote.

Default: 60

Example: `ST,0` // Disable remote configuration
`ST,255` // Enable remote configuration forever

2.2.20 SU,<value>

The set UART baud rate command sets the baud rate where <value> is 1200, 2400, 4800, 9600, 19.2, 28.8, 38.4, 57.6, 115K, 230K, 460K, or 921K. You only need to specify the first 2 characters of the desired baud rate.

Note: After a factory reset, the device returns 0 when you issue the `GU` command, however, the module communicates at 115K.

Default: 115,200

Example: `SU,57` // Set the baud rate to 57,600

2.2.21 SW,<value>

This command enables low-power Sniff mode, which allows extremely low-power operation. In the mode, the device goes into a deep sleep and wakes up every $625 \mu\text{s} \times \text{<value>}$ to send/receive data. For example, the `SW,0050` setting ($0 \times 50 = 80$, $80 \times 625 \mu\text{s} = 50 \text{ ms}$) causes the module to enter low-power sleep and wake once every 50 ms to check for RF activity.

This setting is useful for applications in which the device is connected and sending data. Data is not lost; however, it may have a delay. See “Sniff Mode” on page 42 for more details on this mode and managing power.

Default: 0000 // Disable Sniff mode
 Example: SW,0050 // Enable Sniff mode with interval time of // 50 ms

2.2.22 SX,<flag>

The bonding command determines which connections the device accepts, where <flag> is a value shown in Table 2-11. If bonding is enabled, the device only accepts connections from the device that matches the stored Bluetooth address register. You can set the stored address register with the SR command or it can be set upon the first device pairing.

TABLE 2-11: BONDING VALUES

Flag	Description
0	Disable.
1	Enable.

Default: 0
 Example: SX,1 // Enable bonding

2.2.23 SY,<hex value>

This command sets the module’s transmit power, where <hex value> represents the desired power setting.

In August 2012, Roving Networks changed the power setting hex values. The new power setting:

- Uses the desired power value instead of an arbitrary value
- Shifts the power range up to use the highest transmit power
- Provides more evenly spaced linear power values.

Table 2-12 describes the SY, power settings for August 2012 and later.

TABLE 2-12: POWER SETTINGS (AUGUST 2012 AND LATER)

Hex	Power (dBm)
0010	16
000C	12
0008	8
0004	4
0000	0
FFFC	-4
FFF8	-8
FFF4	-12

Table 2-13 describes the power settings for the `SY`, command prior to August 2012.

TABLE 2-13: POWER TABLE (BEFORE AUGUST 2012)

Hex	Power (dBm)
0004	12
0000	6
FFFC	2
FFF8	0
FFF4	-5
FFF0	-10
FFE8	-20

Default: 16

Example: `SY,000C` // Set the power to 12 dBm

To determine which power settings your module uses, you restore your module to the factory defaults and then view the power setting. The factory default is for the module to use maximum power. Therefore, if the power setting displays as 10 hex (16 decimal), the module uses the new power settings. If the power displays as 4 hex (12 decimal), the module uses the old power settings.

To find the power setting:

1. Type `$$$` in a console to put the module into command mode.
2. Type `SF,1 <cr>` to restore the factory defaults.
3. Type `R,1 <cr>` to reboot the module.
4. Type `$$$` to go into command mode.
5. Type `GY <cr>` to view the power setting.

2.2.24 **SZ,<value>**

You use this command to specify non-standard raw baud rates, where `<value>` is a decimal number based on the formula `<value> = baud rate x 0.004096`. This setting takes effect after rebooting.

Default: N/A

Example: `SZ,39` // Set the baud rate to 9,521.48

2.2.25 S~, <value>

This command sets the profile, where <value> is shown in [Table 2-14](#). See “[Profile Settings & Features](#)” on [page 46](#) for more details on profiles.

TABLE 2-14: PROFILE VALUES

Value	Profile	Comments
0	SPP	Default, no modem control.
1	DUN-DCE	Slave or gateway. Note 1
2	DUN-DTE	Master or client. Note 1
3	MDM SPP	With modem control signals. Note 1 , Note 2
4	SPP and DUN-DCE	Multi-profile. Note 1
5	APL	Apple (iAP) profile. Refer to the <i>iAP Bluetooth Evaluation Kit for Developing Accessories Compatible with iOS Devices User Manual</i> for more information on using this profile.
6	HID	HID profile. To use the Bluetooth HID profile, the device must be running a special firmware version. See Chapter 5. “HID Profile” for more information.
<p>Note 1: Refer to “Profile Settings & Features” on page 46 for information on modem control signals and GPIO assignments.</p> <p>2: In this mode, GPIO11 is reserved for RTS.</p>		

Default: 0

Example: S~, 0 // Set profile to SPP

2.2.26 S-, <string>

This command sets the serialized friendly name of the device, where <string> is up to 15 alphanumeric characters. This command automatically appends the last 2 bytes of the Bluetooth MAC address to the name, which is useful for generating a custom name with unique numbering.

Default: N/A

Example: S-, MyDevice // Set name to “MyDevice-ABCD”

2.2.27 S?,<flag>

The role switch command enables and disables the role switch, where <flag> is shown in Table 2-15. If the switch is set, when a slave mode device receives an incoming connection, the device tries to force a role switch, allowing the slave to become the master. This option is useful in situations where the local device sends high-speed data up to the remote host, and can result in better performance. However, this setting may create a situation in which the connecting host cannot make additional outbound connections (multi-point) while connected to this device.

TABLE 2-15: ROLE SWITCH VALUES

Flag	Description
0	Disable.
1	Enable.

Default: 0

Example: `S?,1` // Enable role switch

2.2.28 S\$,<char>

This command sets the configuration detect character string, where <char> is a single character. This setting allows you to change the default string to go into command mode (\$\$\$) to some other character string. Restoring the factory defaults returns the device to using \$\$\$.

Default: \$

Example `S$,#` // Set ### as string to go into command mode

2.2.29 S|,<value>

The low-power connect mode command disables the Bluetooth radio and LED timers while not connected, where <value> is a 4-digit number made up of two 1-byte intervals. The first interval is the off period and the second the on period. Both are in hex seconds (not decimal). The maximum value for either interval is 20 seconds. The default is 0000, which indicates always actively waiting for a connection.

When this option is set, the module cycles between active (discoverable and connectable) and low-power deep sleep. This setting can save considerable power when the module is waiting for a long time without a connection. The trade off is additional latency when connecting or pairing.

Default: 0000

Example: `S|,2001` // Cycle on for 1 s and OFF for 32 s
// (hex 20 = decimal 32)

2.3 GET COMMANDS

The get commands retrieve and display the device's stored information. These commands do not have a keyword or character and do not take any parameters, except as noted.

2.3.1 D

This command displays basic settings such as the address, name, UART settings, security, pin code, bonding, and remote address.

Example: `D` // Display basic settings

2.3.2 E

This command displays the device's extended settings such as the service name, service class, device class, and configuration timer.

Example: `E` // Display extended settings

2.3.3 GB

This command returns the device's Bluetooth address.

Example: `GB` // Display the device's Bluetooth address

2.3.4 GF

This command returns the Bluetooth address of the currently connected device. This command can give a different result than the `GR` command, which is the stored remote address for re-connecting.

Example: `GF` // Show Bluetooth address of currently
// connected device

2.3.5 GK

This command returns the device's current connection status. 1,0,0 indicates the device is connected; 0,0,0 indicates that it is not connected.

Note: If diagnostic messages are enabled (using the `SO,%` command) and the device is not connected, `NO_AUTH_CHIP` is displayed on the UART and the module returns the error code 8 when you issue the `GK` command.

Example: `GK` // Show the current connection status

2.3.6 GR

This command shows the remote address.

Example: `GR` // Display remote address

2.3.7 G&

This command returns a hex byte containing the value of the GPIO pins.

Example: `G&` // Show the GPIO pin values.

2.3.8 **G<char>**

This command displays the stored settings for a set command, where *<char>* is a set command name.

Example: `GS` // Return 1 or 0 depending on the security
// value

2.4 CHANGE & ACTION COMMANDS

Change commands temporarily change the value of various settings such as serial baud rate, parity, etc. Action commands perform actions such as inquiries, connecting, and entering/exiting command mode.

2.4.1 **\$\$\$**

This command causes the device to enter command mode, displaying `CMD`. The device passes characters as data until it sees this exact sequence. If the device sees any bytes before or after the `$$$` characters in a 1 second window, the device does not enter command mode and these bytes are passed through.

You can change the character string used to enter command mode with the `S$` command.

Example: `$$$` // Enter command mode

2.4.2 **---**

This command causes the device to exit command mode, displaying `END`.

Example: `---` // Exit command mode

2.4.3 **+**

This command toggles the local echo on and off. If you send the `+` command in command mode, all typed characters are echoed to the output. Typing `+` a second time turns local echo off.

Default: Off

Example: `+` // Turn local echo on

2.4.4 **&**

This command returns the evaluation kit's dipswitch values or GPIO3, 4, 6, 7 values on other modules.

Example: `&` // Display dipswitch or GPIO values

2.4.5 **C**

This command causes the device to attempt to connect to the stored remote address.

Example: `C` // Connect to stored remote address

2.4.6 C,<address>

This command causes the device to connect to a remote address, where <address> is specified in hex format. The address is also stored as the remote address.

```
Example: C,00A053112233           // Connect to the Bluetooth address
                                     // 00A053112233
```

2.4.7 CF,<address>

This command causes the device to connect to <address> and immediately go into fast data mode.

Note: You cannot enter command mode while connected using this command. However, GPIO6 can still be used to disconnect. Therefore, you should hold GPIO6 high before sending this command because if GPIO6 goes low, the device disconnects.

```
Example: CF,00A053112233         // Connect to 00A053112233 in fast data
                                     // mode
```

2.4.8 CFI

This command causes the device to connect and immediately go into fast data mode using the last address found with the inquiry command.

Note: You cannot enter command mode while connected using this command. However, GPIO6 can still be used to disconnect. Therefore, you should hold GPIO6 high before sending this command because if GPIO6 goes low, the device disconnects.

```
Example: CFI                       // Connect to last found address in fast
                                     // data mode
```

2.4.9 CFR

This command causes the device to connect and immediately go into fast data mode using the stored remote address. This command is similar to the c command, except it bypasses the configuration timer.

Note: You cannot enter command mode while connected using this command. However, GPIO6 can still be used to disconnect. Therefore, you should hold GPIO6 high before sending this command because if GPIO6 goes low, the device disconnects.

2.4.10 CT,<address>,<value>

This command uses a timer to control the connection duration, where <address> is the connection address (required) and <value> is the length of the timer in ¼ seconds up to 255 (optional). For example, a <value> of 255 is 64 seconds.

The device does not use or store a remote address. The device automatically disconnects after 7 seconds if no data is seen from the UART or over Bluetooth. You can use the optional timer <value> to change the timer length.

```

Example: CT,00A053112233           // Connect to 00A053112233 and
                                     // disconnect after 7 seconds if
                                     // no data is seen from UART or Bluetooth

      CT,00A053112233,120         // Connect to 00A053112233 and
                                     // disconnect after 30 seconds if
                                     // no data is seen from UART or Bluetooth

```

2.4.11 F,1

This command ends configuration immediately and puts the device into fast data mode.

```

Example: F,1                       // Leave command mode and enter fast
                                     // data mode

```

2.4.12 H

The help command displays a list of commands and their basic syntax.

```

Example: H                         // Display help

```

2.4.13 I,<value 1>,<value 2>

This command performs an inquiry scan, where <value 1> is the scan time in seconds and <value 2> is the optional COD of the device class for which you are scanning. The default time is 10 seconds, and the maximum is 48. If <value 2> is unused or set to 0, the device looks for all device classes. When entering a COD, you must provide all six characters, e.g., you would enter 0040F0 for COD 0x40F0. The scan returns a maximum of 9 devices. As devices are found, they are displayed in the format:

```

<Bluetooth address>,< Bluetooth name>,<COD>00A053000123,MySerial-
Port,72010C

```

Default: 10 seconds, no COD

```

Example: I,20,0040F0              // Scan for 20 seconds using the COD
                                     // 0x40F0

```

2.4.14 IN<value 1>,< value 2>

This command is similar to the I command, but it does not return the Bluetooth name, where <value 1> is the scan time in seconds and <value 2> is the optional COD of the device class for which you are scanning. Therefore, the device returns the scan result much faster because the device does not have to perform a remote lookup for each device found.

```

Example: IN10,001F00             // Scan for 10 seconds using the COD
                                     // 0x1F00

```

2.4.15 IQ

This command scans for Bluetooth devices in pairing mode and returns the RSSI, which is an indicator of the signal quality for remote devices. Inquiry scanning with RSSI is part of the Bluetooth specification where the Tx power is held a constant level (no power control) while sampling the RSSI. A useful application for RSSI scanning is proximity based pairing.

```

Example: IQ                       // Scan for devices and return their RSSI

```

2.4.16 IS<value>

This command performs an inquiry scan with a COD of 0x001F00, which is the default COD for Roving Networks modules, where <value> is the scan time in seconds.

Example: `IS10` // Scan for Roving Networks devices for
// 10 seconds

2.4.17 IR<value>

This command performs an inquiry scan with a COD of 0x0055AA, where <value> is the scan time in seconds. Roving Networks modules use this COD for instant cable replacement.

Example: `IR10` // Scan for instant cable replacement
// devices for 10 seconds

2.4.18 J

This command hides the current 4-digit pin code (or pairing code) used for legacy pairing mode or default mode. When the pin code is hidden, the GP, D, and X commands do NOT display the currently assigned pin code.

To disable the pin code hiding:

- Use the `SP,` command to set a new pin code

or

- Restore the factory defaults using the commands

`SF,1`

`R,1`

Example: `J` // Hide the pin code

2.4.19 K,

The kill command disconnects the device the current connection. The characters `KILL<CR><lf>` are echoed to the local UART once the connection is broken.

Example: `K,` // Disconnect the current connection.

2.4.20 L

The link quality command returns the real-time streaming link quality values at 5 Hz. The returned value is two bytes separated by a comma, where ff is the highest value. The first byte is the current reading and the second byte is the low water mark. Example output for RSSI is `ff,e6`.

If the module is not connected, the module responds with `NOT Connected!` when you issue the `L` command.

Example: `L` // Display the real-time streaming link
// quality value

2.4.21 M

This command displays the remote side modem signal status.

Example: `M` // Show the remote side modem signal
// status

2.4.22 O

This command displays other settings, such as the configuration character, I/O port values, and debug mode.

Example: `o` // Show the other settings

2.4.23 P,<char>

This command passes through any <char> up to a carriage return or line feed while in command mode.

2.4.24 Q

This command puts the device into quiet mode, which means it is temporarily not discoverable or connectable. When you issue this command, the device responds `Quiet`. This command does not survive a power cycle or reset.

You use this command with the `z` command. For the lowest power mode, issue `Q` and then `z`. Use the Sniff settings for the lowest power while connected. See “[Power Management](#)” on page 41 for more details on low-power mode.

In firmware version 6.15 and higher, the `Q` command has the following settings that have different responses as follows:

- `Q`—The module is undiscoverable (firmware version 4.77 and 6.15 and higher).
- `Q,0`—The module is discoverable and able to connect. Response is `AOK`. (firmware 6.11 and higher)
- `Q,1`—The module is not discoverable and not able to connect. (firmware version 6.11 and higher)
- `Q,2`—The module is able to connect but is not discoverable. (firmware version 6.11 and higher)
- `Q,?`—Displays the current quiet mode where ? is 0, 1, or 2 as defined above (firmware version 6.15 and higher).

Note: In firmware version 6.11 and 6.12, the `Q` command displays the quiet mode.

2.4.25 R,1

This command forces a complete device reboot (similar to a power cycle).

Note: Any changes to the device configuration using the set commands will not take effect until you reboot the device.

2.4.26 T,<flag>

This command passes received data (from the UART or Bluetooth) while in command mode according to the <flag> value shown in [Table 2-16](#).

TABLE 2-16: T COMMAND VALUES

Flag	Description
0	Disable.
1	Enable.

Example: `T,1` // Pass received data while in command mode

2.4.27 U,<value 1>,<value 2>

This command causes a temporary UART change, where <value 1> is the baud rate and <value 2> is the parity. This command changes the serial parameters immediately, but does not store them to flash memory. The device returns `AOK` at the current settings, then automatically exits command mode and switches to the new baud rate.

The baud rate, <value 1>, must be EXACTLY 4 characters: 1200, 2400, 4800, 9600, 19.2K, 38.4K, 57.6K, 115K, 230K, 460K, or 921K. The parity, <value 2>, is E, O, or N (must be capital letters).

Default: 60

Example: `U,9600,E` // Set the baud rate to 9,600 with even
// parity

2.4.28 V

This command displays the firmware version.

Example: `v` // Show the firmware version

2.4.29 W

This command enables discovery and connection after it has been disabled with the `Q` command. It reloads the stored value of the inquiry and page window to re-enable. The device returns `Wake` as a response.

Note: For backwards compatibility with firmware version 4.77, this command is available in firmware version 6.15 and higher.

In firmware version 6.11, the `w` command is deprecated. Instead, use `Q,1`.

Example: `SI,0000` // Turn off discovery but still allow
// connections
`W` // Turn on discovery and connections

2.4.30 Z

When you use this command, the device enters low-power, deep sleep mode (<2 mA) when NOT connected. To exit this mode, power cycle the device or toggle the module's reset pin (causing a hard reset). For more information on managing power, see ["Power Management" on page 41](#).

2.5 GPIO COMMANDS

GPIO commands configure and manipulate the module's GPIO signals. Each GPIO command takes a 16-bit parameter made up of 2 bytes. The first byte is a mask to specify the GPIO number and the second byte is the command's value:

`PARAMETER[15:0] = MASK[7...0]<<8 || VALUE[7..0]`

2.5.1 S@,<hex value>

This command sets the GPIO pin's direction (input or output). This setting is lost when power is cycled.

2.5.2 S<, <hex value>

This command sets the GPIO pin's value. This setting is lost when power is cycled.

2.5.3 S%, <hex value>

This command stores the GPIO pin's direction for use on power up.

2.5.4 S^, <hex value>

This command stores the GPIO pin's powerup value.

2.5.5 S*, <hex value>

This command sets values for GPIO8, GPIO9, GPIO10, and GPIO11.

2.5.6 Controlling the GPIO Pins

Two registers control the GPIO pins:

- The direction register controls whether the GPIO is an input or an output.
- The second register is the value to apply to the GPIO if it is an output, or it is the value of the built-in, weak pull-up resistor if the GPIO is an input.

These settings are immediate and do not survive a power cycle.

```
Example: s@, 8080 // Set GPIO7 as an output
          S&, 8080 // Drives GPIO7 high
          S&, 8000 // Drives GPIO7 low
```

2.5.7 Setting GPIO Pin Power-Up Values

There are two additional registers that control the GPIO pin direction and value on power up. You set these registers with the s% and s^ commands.

```
Example: s%, 0101 // Set GPIO0 as an output on power-up
          S^, 0303 // Drive GPIO0 high and pull up GPIO1
```

You can set multiple bits can be set with a single command. Any bits with a mask of 0 are unaffected.

Some GPIO pins are read at power-up to perform certain functions; therefore, you must be careful when manipulating them. For example, you can use GPIO3 and GPIO6 to set master mode and auto discovery automatically. If you want to use these GPIO pins for other purposes at power-up, you must disable the module from sensing these GPIO pins upon power-up by using the sQ, 4 command. This command sets a flag in a stored register that is read at power-up. View the GPIO pin's power-up settings using the o (other settings) command.

WARNING

GPIO4 is used by the system to reset stored parameters to factory defaults. If GPIO4 is pulled high on power-up and then toggled 3 times, all user settings returns to the factory default values. Therefore, you should not use this pin as an output and your system should not drive it high at power-up (first 1 second of operation).

GPIO2 and GPIO5 are driven by the embedded software as outputs. You can disable them using the direction command (for example to save power) and then use them as inputs. If these pins are set as outputs the software overrides any user values.

2.5.8 Setting GPIO8, GPIO9, GPIO10 & GPIO11

You use the `s*` command to set these GPIO pins:

```
s* ,<hex value> = MASK[11..8] VALUE[11..8]
```

For the upper 4 GPIO pins, a single word controls the mask and values,. Only the lower 4 bits of each byte are used. The first time you use this command, all 4 GPIO pins are driven as outputs and remain as outputs until a power cycle. These bits cannot be set to be read on powerup. Some modules do not offer these GPIO pins.

```
Example: s* ,0101 // Drive GPIO8 high
          s* ,0100 // Drive GPIO8 low
          s* ,0202 // Drive GPIO9 high
```

NOTES:

Chapter 3. Advanced Topics

This section provides information on advanced topics such as power management, profile settings, design concerns, etc.

3.1 POWER MANAGEMENT

There are five different methods to lower Bluetooth device power consumption. Some methods only have an effect when the device is in certain Bluetooth states (i.e., when connected or disconnected). Additionally, each method has advantages, disadvantages, and requirements. [Table 3-1](#) summarizes these methods.

TABLE 3-1: POWER MANAGEMENT METHODS

Method	Bluetooth State	Advantages	Disadvantages
Optimize Inquiry (Discovery) and Page (Connection) Window	Idle (Not Connected) or Active Connection	The current can be reduced from more than 20 mA to less than 5 mA (combining this method with Sniff mode uses less than 3 mA).	Causes additional latency when pairing or connecting.
Sniff Mode	Transmit Active Connection	This mode can be combined with the Optimize Inquiry (Discovery) and Page (Connection) Window or Enable Deep Sleep methods for lower power consumption.	-
Enable Deep Sleep	Idle (Not Connected)	With this method, current is reduced to about 300 μ A.	This method can cause latency issues and may drop the first byte if the device wakes on RX data. It also causes a loss of performance/power when the device wakes frequently.
Disable Output Drivers	Idle (Not Connected) or Active Connection	This method is simple to use. However, it depends on the load: if the device is not connected there are no power savings. This method is required for Roving Networks evaluation boards to measure power accurately.	External components driven by GPIO pins may not work properly.
Lower Transmit Power	Idle (Not Connected) or Active Connection	This method lowers power consumption during Txmt and active mode by reducing radio output power.	The device has a shorter effective range.

3.1.1 Optimizing Inquiry (Discovery) & Page (Connection) Windows

In slave mode, there are two timers that can be used to lower radio power while idle. When not connected, the Bluetooth radio is active when listening for other devices. Other devices can discover (inquire) or connect (page) to the device. The amount of time the radio listens is called the window, and the interval at which the process repeats is called the interval.

For Roving Networks devices, the inquiry and page window is fixed at is 0x1000 (2.56 seconds). The default window is 0x0100 (160 ms) or a 6.25% duty cycle. By lowering the window values, you can save power at the expense of possibly missing an inquiry or page request. Because the host usually retries many times automatically, the only downside is a delay in discovery or connection time.

You adjust the inquiry scan window using the `SI` command. The minimum window for inquiry or page is 0x0012 (11.25 ms), which corresponds to about a 0.5% duty cycle.

Example: `SI,0200` // Set the inquiry scan window to 0x0200

You adjust the page scan window using the `SJ` command. The minimum window for inquiry or page is 0x0012 (11.25 ms), which corresponds to about a 0.5% duty cycle.

Example: `SJ,0200` // Set the page scan window to 0x0200

Thus, you can reduce the average power from more than 20 mA to less than 5 mA in standard mode and less than 3 mA in Sniff mode.

It is also possible (and desirable for security reasons) to completely disable inquiry. Once a host has found and installed a device, inquiry is not required, only page is used to make a connection. To disable inquiry while still allowing connections, set the inquiry timer to 0 with the `SI,0000` command.

3.1.2 Sniff Mode

Sniff mode, a Bluetooth power conservation method, only pertains to an active connection. In Roving Networks devices, Sniff mode is disabled by default and the radio is active continuously when connected (about 25 to 30 mA). In Sniff mode, the radio wakes up at specific intervals and sleeps in very low power mode (around 2 mA) the rest of the time. With Sniff mode, the power savings can be quite dramatic.

To enable Sniff mode, use the `SW, <hex value>` command. Example interval timers:

0x0020 = 20 ms (32 decimal * .625 = 20)

0x0050 = 50 ms

0x00A0 = 100 ms

0x0190 = 250 ms

0x0320 = 500 ms

0x0640 = 1 second

When a connection is made, both master and slave must support Sniff mode and agree to the Sniff window, otherwise, the radio remains in full active mode.

Note: The maximum allowed Sniff interval is about 20 seconds, which is 0x7FFF.

3.1.3 Enabling Deep Sleep

You can use deep sleep mode to obtain extremely low power operation. In this mode, the device shuts down completely and only draws about 300 μ A of current. To enable deep sleep, set the high-order bit of the Sniff word to 0x8000. This bit is NOT used to determine the sleep interval, it is only used as a flag to enable deep sleep.

Example: `SW,8320` // 1/2 second sleep (0x0320), with deep
// sleep enabled

In normal low-power sleep (not deep sleep) the firmware is still running in idle mode, and wakes up about 20 times per second to check ports, update LEDs, etc. During deep sleep, the firmware actually stops running some tasks. For example, the LEDs only update about once per second. There are 3 ways to wake the radio from sleep mode:

- Send a character to the UART.
- Transition the RX pin. The worst-case wake time is 5 ms. Therefore, the radio generally loses the first character sent. A better way to wake the radio is to toggle

the CTS line from low to high, wait 5 ms, and then send data.

- The radio can wake automatically every *<hex value>* slot times (1 slot time is 625 μ s) as defined previously. The radio wakes and listens to see if the other side of the connection has anything to send. This wake time is typically about 5 ms (8 slots) even if no data is to be transferred.

Once the radio is awake it stays active for exactly 1 second of inactivity, and then sleeps again.

Note: Setting this mode can cause latency issues and dropped bytes/loss of performance in cases where large amounts of data are being transferred. The nuances of Bluetooth Sniff can be complex. If necessary, contact Roving Networks for more details on how to use Sniff mode.

To enable even lower power utilization, use the `S| ,<hex value>` command to set an on/off duty cycle.

3.1.4 Disabling Output Drivers

Use the `S% ,1000` command to set all GPIO pins (0 to 11) to inputs. This command also turns off the FireFly adapter LED (GPIO5). Refer to “GPIO Commands” on page 37 for more information on using commands to control the GPIO pins.

3.1.5 Lowering Transmit Power

All Roving Networks Bluetooth modules adhere to the Bluetooth (version 1.1, 1.2, and 2.0/2.1) specifications for power control. The RN-21 and RN-41 radios are Class 1 capable.

The radio power output is automatically controlled by the baseband. Depending on the mode (inquiry scan, page scan, connected) the power is adjusted. Once a connection is made, the radios on both sides negotiate a power setting based on the perceived signal strength (RSSI).

The transmit power can be controlled to:

- Reduce effective range for security reasons.
- Lower radio emissions for agency compliancy concerns.
- Reduce total power consumption.

To configure the transmit power, use the `SY ,<hex value>` command, where *<hex value>* is an unsigned hex representation of the setting command. See Table 3-2. The radio can use a value that is lower than the default.

TABLE 3-2: POWER SETTINGS

Hex	Power (dBm)
0010	16 (default)
000c	12
0008	8
0004	4
0000	0
FFFC	-4
FFF8	-8
FFF4	-12

If a non-zero value is stored in the variable, upon power up the radio uses the highest value that is less than or equal to the stored variable.

```
Example: SY,FFF8 // -8 dBm
         SY,0000 // 0 dBm
```

The power setting takes effect after a power cycle, reboot, or reset pin toggle. To check the stored power setting, use the `o` command; the device returns `TX Power=1` (or other setting equal to the value you entered). To view the current power setting, use the `GY` command. The device returns only the actual value with no leading zeroes. The `GY` value may not match the value in the shown with the `o` command due to how the value is used as described previously.

Note: Prior to August 2012, the SY, command used different power settings. Refer to “SY,<hex value>” on page 27 for more information on the old power settings and to determine which power settings your module uses.

3.2 CONFIGURATION TIMER SETTINGS

The module has a remote configuration timer to allow remote configuration over Bluetooth after power up in Slave Mode. In all Master modes, the remote configuration timer is set to 0 (no remote configuration). In Trigger Master Mode, the configuration timer is used as an idle timer to break the connection after time expires with no characters received.

You can only configure remotely if the boot-up configuration timer (default 60 seconds) has not expired. This timer is set to 0 (remote configuration disabled) for Master Mode and Auto-Connect Slave Mode so that data can immediately flow between 2 modules for cable replacement applications. Once the timer has expired, any data sent to the module passes through unmodified and unrecognized by the command interpreter. The timer can be set to any value from 0 (disable remote configuration) to 255 decimal, which allows continuous (no timeout) configuration.

Table 3-3 shows the configuration timer settings.

TABLE 3-3: CONFIGURATION TIMER SETTINGS

Value (Decimal)	Description
0	No remote configuration. No local configuration when connected.
1 - 252	Time in seconds from power up to allow configuration.
253	Continuous configuration, local only.
254	Continuous configuration, remote only.
255	Continuous configuration, local and remote.

You use the `ST, <value>` command to change the configuration timer settings. For example:

```
ST,0 // Disable remote configuration
ST,255 // Enable remote configuration forever
```

3.3 INTERFACING TO A MICROPROCESSOR

Roving Networks Bluetooth devices can connect to 3.3-V (only) microprocessors using the UART interface. When interfacing with a microprocessor, use the following guidelines:

- The Bluetooth device power, ground, RX, and TX signals must be connected and CTS should be held low or tied to RTS.
- The Bluetooth device can go into command mode 500 ms after booting.
- The microprocessor should send \$\$\$ with no carriage return or line feed to enter command mode.

3.3.0.1 HOW DO I KNOW THE MODULE IS READY FOR COMMAND MODE?

500 ms after rebooting, the module is ready for command mode. You send \$\$\$ with no carriage return.

3.3.0.2 WHICH HARD SIGNALS SHOULD I CONNECT?

You should connect power, ground, RX, and TX. CTS should be low or you can connect or tie it to RTS.

3.4 HCI MODE

Roving Networks offers the Host Controller Interface (HCI) mode in addition to the standard operational mode of its Bluetooth modules (standard mode refers to the on-board stack running on the module).

In HCI mode, the on-board stack is bypassed and the module is put in a state that runs the Bluetooth baseband. The HCI provides a command reference interface to the baseband controller and the link manager, and provides access to the hardware status and control registers. This interface provides a uniform method for accessing the Bluetooth baseband capabilities.

In this mode, the Bluetooth stack is no longer on-board the module. It is offloaded to the interfacing host processor. The Bluetooth module is used as a radio, performing the lower level MAC functionalities, while the application stack runs on the host processor.

Using the module in HCI mode allows designers to implement profiles that are not natively supported on the Bluetooth module.

Note: HCI mode requires a separate firmware build that must be loaded into the module's flash at the factory. It cannot be updated in the field or by the user.

Roving Networks offers HCI mode in two hardware interfaces:

- HCI over UART
- HCI over USB

3.4.1 HCI over UART

In this mode, the hardware interface between the host processor and the Bluetooth module is the UART. You must interface the flow control signals between the host processor and the Bluetooth module for the HCI interface to work. Failure to do so can cause the host processor and the Bluetooth module to become out of sync and break the Bluetooth link.

3.4.2 HCI over USB

In this mode, the hardware interface between the host processor and the Bluetooth module is the USB. In this architecture, the Bluetooth module is the USB slave and the host processor is the USB host.

Using the USB interface offers the advantage of a faster data link between the Bluetooth module and the host processor. With this architecture, it is possible to achieve Bluetooth's theoretical maximum throughput of 3 Mbps.

3.5 PROFILE SETTINGS & FEATURES

The default profile for Roving Networks Bluetooth device is the Serial Port Profile (SPP). However, the firmware also supports the DUN profile in both master and slave modes. To change the profile, use the `s~, <value>` command, where `<value>` is shown in [Table 3-4](#). Refer to ["HID Profile" on page 59](#) for more information on using HID.

TABLE 3-4: PROFILE CHANGE VALUES

Value	Profile	Comments
0	SPP	Default, no modem control
1	DUN-DCE	Slave or gateway
2	DUN-DTE	Master or client
3	MDM SPP	With modem control signals
4	SPP and DUN-DCE	Multi-profile
5	APL	iAP data connection to iOS device
6	HID	Human interface device (keyboard, mouse, etc.)

The most common use of DUN profile is to allow a Bluetooth client to connect to a dialup modem. For this mode, use profile 1 (DUN-DCE) or `s~, 1`. You may also want to set the COD so that clients can recognize the device as a Bluetooth modem (COD 0x040210) using the following commands:

```
SC,0004
SD,0210
```

With firmware version 4.74 and higher, the device can connect to either SPP or DUN (but not both at the same time). When a host discovers the device, the device displays both services. The host can connect to either one. The device can also connect using the SPP profile, disconnect, and then connect using the DUN profile.

3.6 USING GPIO PINS AS MODEM CONTROL SIGNALS

RNXX modules can replicate the required modem control hardware signals automatically once a connection is made. These signals are transferred outside the data channel (using RFCOMM control channels) and are automatically updated. The default SPP profile (profile = 0) does not drive these signals or report back inputs. If DUN or MDM profiles are enabled (profile = 1, 2, or 3), the following signals are automatically driven and received:

- Inputs, active low. These signals are read and sent back over Bluetooth to the remote host.
 - GPIO3 = DCD (dipswitch 2)
 - GPIO6 = DSR (dipswitch 3)
 - GPIO7 = CTS (dipswitch 4)
- Outputs. The remote host sends these signals and drives them out.
 - GPIO10 = DTR (active high)
 - GPIO11 = RTS (active low)

On the Firefly module, you can also use the dipswitches to set/clear the DCD, CTS, and DSR signals. The DTR and RTS signals are available on the 9-pin header as well.

3.7 DESIGN CONCERNS

This section provides information on design concerns, such as hardware signals, hardware connections and power, LED status, optimizing for latency and throughput, common problems, etc.

3.7.1 Hardware Signals

The following sections provide information on the reset circuit, factory reset, connection status, SPI bus, and other hardware connections.

3.7.1.1 RESET CIRCUIT

The RN41/RN42 modules contain a 1k pull-up to VCC, and the reset polarity is active low. RN21/RN22 modules contain a 1k pull-down, and the reset polarity is active high.

The module's reset pin has an optional power-on-reset circuit with a delay, which should only be required if the input power supply has a very slow ramp or tends to bounce or have instability on power up. Often a microcontroller or embedded CPU I/O is available to generate the reset once power is stable. If not, designers can use one of the many low-cost power supervisor chips currently available, such as the MCP809, MCP102/121, and Torex XC61F.

3.7.1.2 FACTORY RESET GPIO4

Roving Networks recommends that designers connect the GPIO4 pin to a dipswitch, jumper, or resistor so that it can be accessed. This pin can be used to reset the module to its factory default settings, which is critical in situations where the module has been misconfigured. To reset the module to the factory defaults, GPIO4 should be high on power-up and then toggle low, high, low, high with a 1 second wait between the transitions.

3.7.1.3 CONNECTION STATUS

GPIO5 is available to drive an LED, and it blinks at various speeds to indicate status (see [Table 3-5](#)). GPIO2 is an output that directly reflects the connection state as shown in [Table 3-6](#).

TABLE 3-5: GPIO5 STATUS

GPIO5 Status	Description
Toggle at 1 Hz	The module is discoverable and waiting for a connection.
Toggle at 10 Hz	The module is in command mode.
Low	The module is connected to another device over Bluetooth.

TABLE 3-6: GPIO2 STATUS

GPIO2 Status	Description
High	The module is connected to another device over Bluetooth.
Low	The module is not connected over Bluetooth.

3.7.1.4 USING THE SPI BUS FOR FLASH UPGRADES

While not required, this bus is very useful for configuring the Bluetooth modules' advanced parameters. The bus is required when upgrading the module's firmware. In a typical application, a 6-pin header can be implemented to gain access to this bus. A minimum-mode version might simply use the SPI signals (4 pins) and obtain ground and VCC from elsewhere in the design.

3.7.1.5 HARDWARE CONNECTIONS & POWER

When designing with Roving Networks Bluetooth devices, follow these guidelines:

- Placing 3.3-V DC power into the GPIO pins while they are set up as outputs will permanently damage the radio modules. The failure mode is short across GND and VCC. Use a 10-K Ω resistor in series or a 10-K Ω pull-up resistor for input and output GPIO pins, respectively.
- Do not leave any GPIO pins floating (or have LEDs that might drift up to a voltage such as 1.8 V) because it causes leakage in low-power mode.
- By default, you drive CTS high to enable deep sleep and then wake the device by pulling CTS low. However, in some cases, you may need to tie the CTS pin high (3.3-V inactive) for the module to go into deep sleep. This change must be performed at the factory; contact Roving Networks for more information.
- Connect a common ground when using the external TX/RX inputs 0 – 3.3 V DC.
- For a 3-wire DB-9 interface (TX, RX, and GND only), connect/short CTS to RTS. The factory default is hardware flow control enabled, and CTS and RTS connected.
- When using a 5.0-V DC input, GPIO pins require a voltage divider. A good choice is a 10 K Ω series with 20 K to ground. The GPIO pins are 0 - 3.3 V DC, not 5-V tolerant.
- To obtain the lowest power, the device should be passive (in slave mode and not

trying to make any connections). When sleeping, the device uses 26 μ A.

Note: To connect with Android phones, the module must wake up once in a while and be connectable (in this mode, the radio draws about 25 mA). The minimum wakeup time is 11 ms every 2.5 seconds, which gives an average power of about 200 μ A to be able to connect. You can fine-tune the power usage by and turning the radio off for a number of seconds, e.g., 20 seconds, which draws 26 μ A.

- Hardware communications connections for modules and evaluation board
 - Radio TX \rightarrow RX of the application microcontroller unit (MCU)
 - Radio RX \leftarrow TX of the application MCU
 - Radio RTS \rightarrow CTS of the application MCU
 - Radio CTS \leftarrow RTS of the application MCU

3.7.2 LED Status

Table 3-7 describes the green LED status. If installed on the evaluation board or module, the yellow LED blinks when data is transferred on the DB9 serial port's RX or TX pins. This LED is a physical monitor of the actual voltage, and is not driven by software in the module. If installed, the blue LED indicates the transmit activity on the Bluetooth link over the air interface.

TABLE 3-7: GREEN LED STATUS

Mode	Green LED Blink Rate
Configuring	10 times per second
Startup/Configuration Timer	2 times per second
Discoverable/Inquiring/Idle	Once per second
Connected	Solid On

3.7.3 Optimizing for Latency or Throughput

The firmware must make decisions automatically on when to forward received data coming into the UART RX input out the RF link. By default, the firmware is optimized for throughput. In some cases, especially with smaller, close-spaced incoming data packets, the data can get split, with a partial packet forwarded and other data coming later. Unfortunately, Bluetooth has algorithms that can cause significant latency between packets (> 10 ms) at certain times. If the host protocol expects data to come as contiguous bursts and has short timeouts, this latency can cause errors.

Another optimization method forces the radio to attempt to keep small bursts of data together. In this mode, the firmware is optimized for latency. To enable this mode, use the special debug command `sq,16`, which sets the latency bit in the firmware. To disable this mode, use the `sq,0` command. You can read the register's value with the `gq` command.

Note: This command gives a result in hex even though the command is set in decimal.

3.7.4 Limitations of 7-Bit Data Mode

Roving Networks firmware supports a selectable 7-bit data mode using the `S7,1` command. The Bluetooth hardware, however, does not support 7-bit data, so this function is accomplished in firmware. While completely functional, the 7-bit performance is affected because it works through software emulation. Therefore, this mode has a noticeable latency and character per second processing limit. Roving Networks does not recommend using this mode if the desired serial baud rate is greater than 9,600.

3.7.5 Common Issues

The following sections provide some solutions to common issues.

3.7.5.1 MY BLUETOOTH CLIENT CAN SEE THE FIREFLY MODULE AND ITS SERIAL SERVICE, BUT I CAN'T CONNECT

This issue is most likely caused by a security setting on your client. The FireFly module supports authentication by default if the client requires it (with the default pin code of 1234), but for ease of use, you may want to turn security off on your client. Some clients have these settings turned off by default, others have them turned on. To check and disable security, perform the following steps from a Windows PC:

1. Click **My Bluetooth Places**.
2. Click the **Client Applications** tab under **Bluetooth Device Configuration** (or **Advanced Configuration**).
3. Click the Bluetooth serial port application name.
4. Click the **Properties** button.
5. If **Secure connection**, **Authentication**, or **Encryption** is turned on, turn it off.
6. Click **OK**.

3.7.5.2 HOW DO I CHANGE THE CLIENT'S COM PORT?

The Widcomm stack, the most commonly used stack, allows you to connect to the FireFly module using a virtual COM port mapper. The software installs with a default COM port, usually COM3, COM4, or COM5. To change this setting, perform the following steps on a Windows PC:

1. Click **My Bluetooth Places**.
2. Click the **Client Applications** tab under **Bluetooth Device Configuration** (or **Advanced Configuration**).
3. Click the Bluetooth serial port application name.
4. Click the **Properties** button.
5. Change the COM port setting.
6. Click **OK**.

3.7.5.3 HOW DO I CONNECT TO MORE THAN ONE FIREFLY MODULE FROM THE SAME CLIENT AT THE SAME TIME?

Bluetooth allows 7 devices to connect at a time in a piconet. The Widcomm stack allows you to create multiple instances of the serial port profile and connect to multiple FireFly modules at the same time. To connect to multiple modules, perform the following steps on a Windows PC:

1. Click **My Bluetooth Places**.
2. Click the **Client Applications** tab under **Bluetooth Device Configuration** (or **Advanced Configuration**).
3. Click the Bluetooth serial port application name.
4. Click the **Add COM Port** button.
5. Add another Bluetooth serial port and assign it to another virtual COM port (such as COM9).
6. Click **OK**.

3.7.6 Discovery & Connection Example Sequence

The following example goes through a master discovery/connection sequence from power up and no connection.

1. Perform an inquiry to obtain the Bluetooth address (unless it is already known).

```
Send: $$$ // Places radio in command mode
Reply: CMD<cr>
Send: I, 30<cr> // Look for Bluetooth devices
Reply: 00A096112233, 1F00<cr> Inquiry Done<cr>
```

2. Store the remote address that you just found.

```
Send: SR, 00A096112233<cr> // or type SR,I if this was the only device
// found
Reply: AOK<cr>
```

3. Connect.

```
Send: C<cr> // Places the radio in connect mode
Reply: AOK<cr>
```

The device attempts to connect to the remote slave. The terminal displays TRYING while the device attempts to connect.

```
Reply: <string>CONNECT<cr> // Where <string> is an alphanumeric
// string defined in the stored parameters
```

4. Send/receive data.

3.7.7 Auto-Pairing/Auto-Connection

You can use the GPIO pins/dipswitches for auto-pairing and auto-connection. [Table 3-8](#) shows the function for various settings of the GPIO pins/dipswitches.

TABLE 3-8: GPIO PIN/DIPSWITCH SETTINGS FOR AUTO-PAIRING/CONNECTION

GPIO3/Dipswitch 2	GPIO6/Dipswitch 3	Function
Low	Low	Default slave, no special function.
High	Low	Slave, changes COD to 0x0055aa for auto pairing.
Low	High	Auto master, the module uses the stored address and does not try auto pairing.
High	High	Auto master, auto pairing, the module looks for the first device with 0x55aa, stores it, and connects to it.

To enable cable replacement, set GPIO3 high on the slave device and GPIO3 and GPIO6 high on the master. Once paired, GPIO3 is low on both devices (so re-pairing with another Roving Networks device does not occur).

3.8 SERIAL ADAPTER CONFIGURATION

The Bluetooth serial adapters have male or female DB9 connectors. Refer to [Figure 3-1](#) and [Table 3-9](#) for the pin-out.

FIGURE 3-1: DB9 CONNECTOR PINS

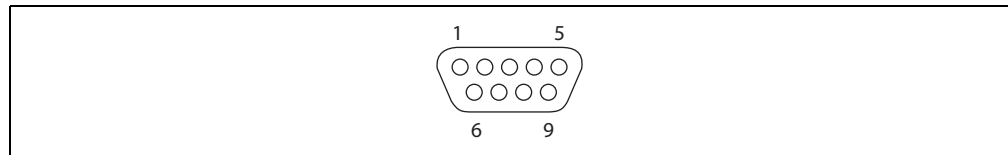

TABLE 3-9: DB9 CONNECTOR PIN-OUT

Pin	RN220XP& RN270M Male DB9	RN240F & RN270F Female DB9	RN422M & RN274M Male DB9
1	NC	NC	NC
2	RXD	TXD	NC
3	TXD	RXD	RXD-
4	NC	NC	TXD+
5	GND	GND	GND
6	NC	NC	+5 VDC (Input)
7	RTS	CTS	RXD+
8	CTS	RTS	TXD-
9	4 – 12 VDC	4 – 12 VDC	NC

Note: The RS-232 interface uses the SIPEX SP3232ECA chip with capacitor switch to generate the + and – signals; therefore, it is not driving the full RS-232 voltages. Devices stealing power from the RS-232 pins may not have enough voltage.

3.9 NULL MODEM & FLOW CONTROL JUMPERS

You can configure the adapter's serial interface to enable flow control and null modem signaling. You access the jumper block by removing the cover from the Bluetooth serial adapter. [Figure 3-2](#) and [Figure 3-3](#) show the jumper settings.

FIGURE 3-2: RN422, RN240, RN270 & RN274 JUMPERS

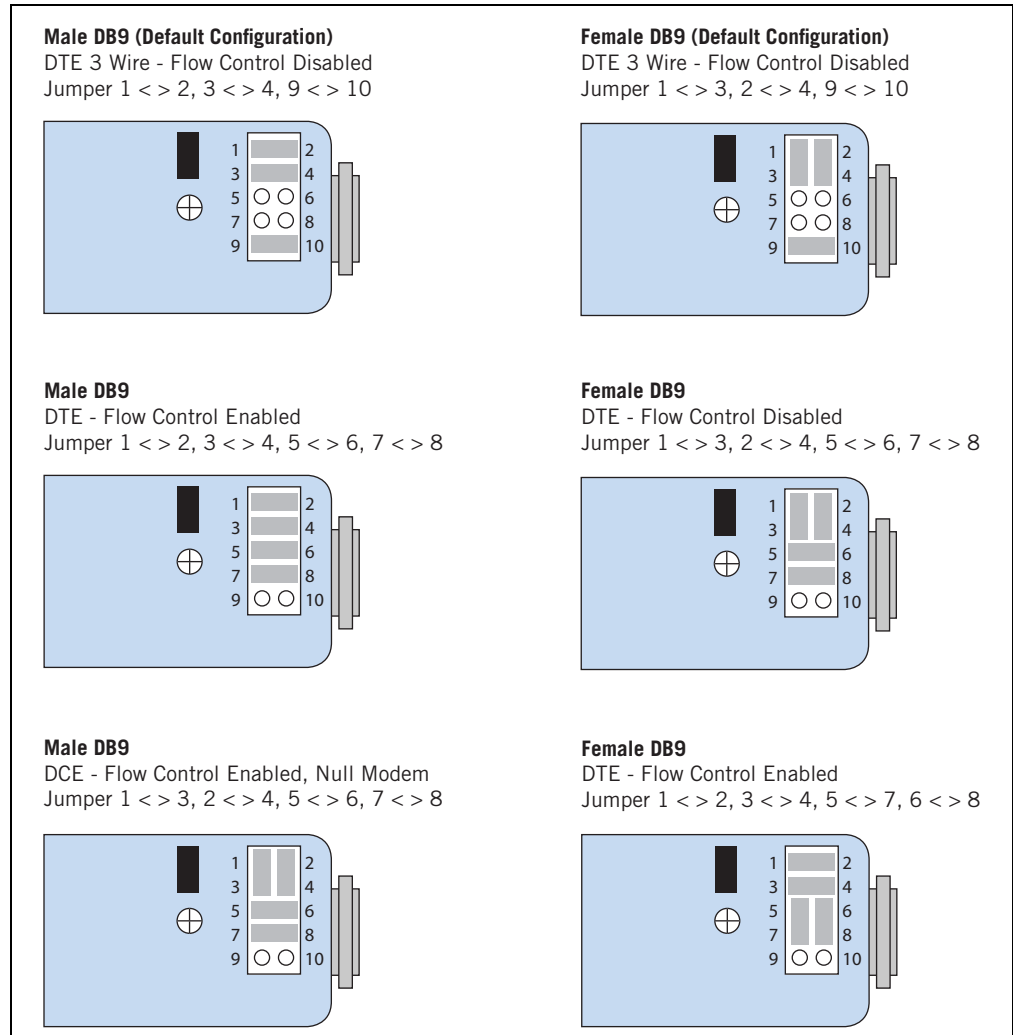
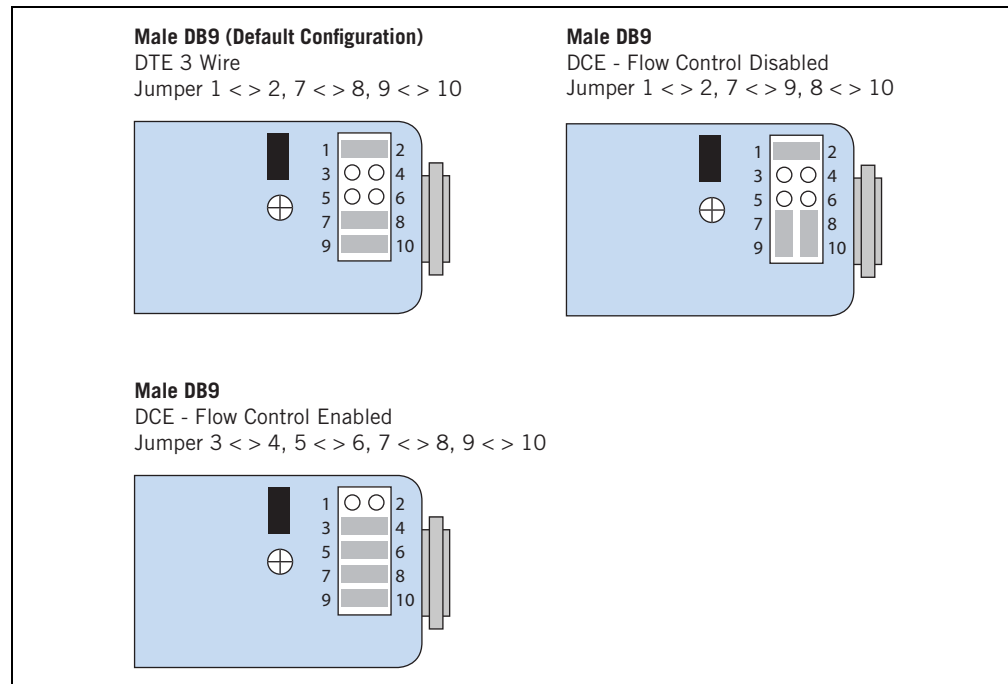

FIGURE 3-3: RN220XP JUMPERS



3.10 DIPSWITCH SETTINGS

The adapters have small configuration dipswitches on the top. You need a paper clip or small screwdriver to flip them. Holding the adapter with the DB9 connector facing to the right, refer to [Figure 3-4](#) for the dipswitch numbering and on/off positions.

FIGURE 3-4: DIPSWITCHES

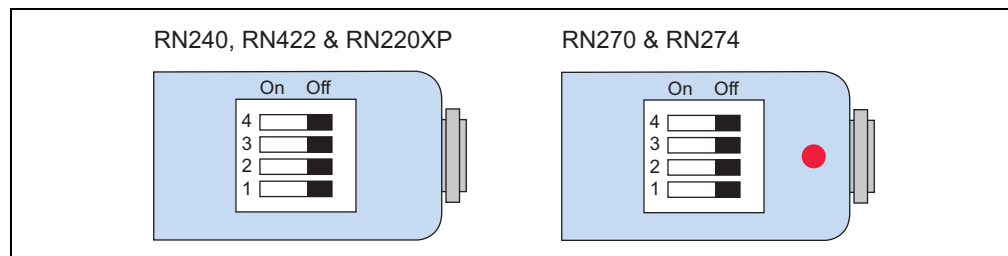

Table 3-10 describes the functions controlled by the dipswitches.

TABLE 3-10: SWITCH FUNCTIONS

Dipswitch	Function	Description
1	Restore factory defaults	Turn on the switch, power up the adapter, and toggle the switch ON-OFF-ON-OFF-ON to return the adapter to its factory settings. The green LED blinks quickly for a moment and then continues to blink about once per second.
2	Automatic discovery	In slave mode, this dipswitch sets a special class of device that is used by the master to auto connect. If dipswitch 3 also turned on, the adapter performs a search, stores, and connects to a remote Roving Networks Bluetooth device that has dipswitch 2 turned on.
3	Automatic master	With this dipswitch turned on, the adapter acts as Bluetooth master and auto-connects to a stored remote address. You must first set the Bluetooth address of the slave device using the <code>SR</code> command or using instant cable replacement settings.
4	Default baud rate	With this dipswitch turned off, the default 115 K baud rate is overridden by software baud rate configuration commands. If this dipswitch is turned on, the baud rate is 9600 and the adapter ignores the software configuration.

NOTES:

Chapter 4. Applications

The following sections describe how to use Roving Networks Bluetooth devices for instant cable replacement.

4.1 INSTANT CABLE REPLACEMENT

You can configure a pair of Roving Networks serial adapters (with or without the Fire-Plug USB dongle, RN-USB-X) to provide an instant serial cable replacement. The two adapters are paired using either:

- Hardware pairing via dipswitches
- Configured using software commands

4.1.1 Hardware Pairing Using Dipswitches

To pair using hardware, perform the following steps:

1. Turn off the adapters and set the dipswitches as shown in [Figure 4-1](#).

FIGURE 4-1: CABLE REPLACEMENT DIPSWITCH SETTINGS FOR

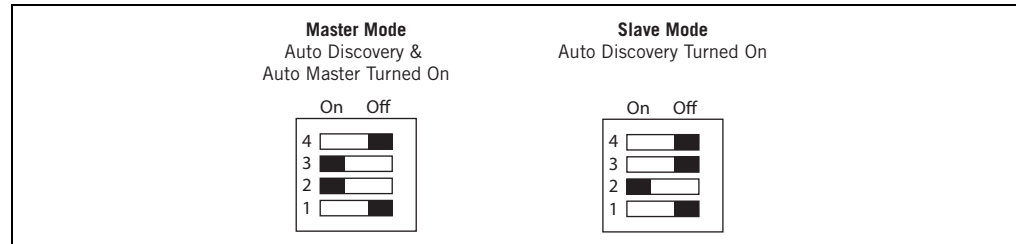

PAIRING

2. Power up both devices. The master discovers the slave device, stores its Bluetooth address, and connects. The devices are now paired and each device's green LED should be on solid.
3. The devices are now paired. Set dipswitch 2 on both devices to off so that they do not try to re-pair each time power is cycled. See [Figure 4-2](#).

FIGURE 4-2: SETTING DIPSWITCH 2 FOR DEPLOYMENT

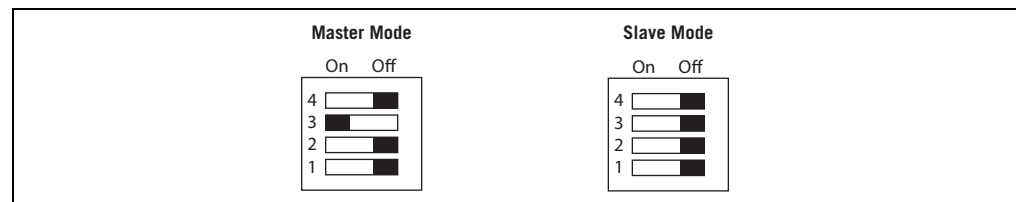

Once paired, when the devices are in range of each other, they connect and the master will not attempt to connect to any other Bluetooth device. To break the pairing, restore the factory defaults using dipswitch 1.

4.1.2 Software Pairing Using Commands

To configure the master and slave devices for instant cable replacement, connect your terminal emulator on the host to the devices via the COM port using the settings 115,200 baud, no parity, 8 bits, 1 stop bit, and no flow control.

On the slave device, issue the following commands:

1. Put the device in command mode by sending the \$\$\$ command. The device returns `CMD` to indicate it is in command mode.
2. Send `SM,0<cr>` to put the device into slave mode.
3. Verify that the device is in slave mode by issuing the `D` action command. Look for the `MODE =Slav` message.
4. Reboot the device using the `R,1<cr>` command. The changes do not take effect until the device is rebooted.

On the master device, issue the following commands:

1. Put the device in command mode by sending the \$\$\$ command. The device returns `CMD` to indicate it is in command mode.
2. Send `SM,1<cr>` to put the device into slave mode.
3. Verify that the device is in slave mode by issuing the `D` action command. Look for the `MODE =Mstr` message.
4. Ensure that the slave device is turned on, and send the `I<cr>` inquire command.
5. Locate the slave's (remote side) Bluetooth address (BTA) in the results of the inquiry command. The BTA is a 6-byte (12 hex-characters) value.
6. Store the remote BTA using the `SR,<address><cr>` command. For example, if the remote BTA is 000666037083, enter the command `SR, 000666037083<cr>` to store the remote address.
7. Reboot the device using the `R,1<cr>` command. The changes do not take effect until the device is rebooted. The master device restarts and connects with the remote slave device. A solid green LED indicates that the devices are connected.

For more information on instant cable replacement, refer to the *Bluetooth Cable Replacement Application Note* on the Roving Networks website at http://www.roving-networks.com/Support_Overview.

Chapter 5. HID Profile

5.1 OVERVIEW

Roving Networks Bluetooth modules support a variety of Bluetooth profiles, including human interface device (HID), serial port profile (SPP), DUN, HCI, and iAP for use with iPad, iPod and iPhone devices. The Bluetooth HID profile enables customers to develop wireless products such as computer keyboards and keypads, trackballs, mice, and other pointing devices, and game controllers (gamepads, joysticks, steering wheels, etc.). Additionally, Roving Networks has extended the basic HID capability to allow programmability and control of devices such as the iPad.

The HID profile defines the protocol between:

- *Device (HID)*—Services human data input and output to and from the host.
- *Host*—Uses or requests the services of a human interface device.

The Bluetooth HID profile allows users to control the HID descriptor, which defines the device's feature set, and the HID report, which host uses to interpret the data as ASCII values, movement, etc. The HID report format follows the standard universal serial bus (USB) HID protocol as to leverage existing host drivers.

In a typical usage scenario such as a keyboard, a device using the Roving Networks Bluetooth HID profile replaces the USB cable. In this case, the ASCII value of a key press is converted to a scan code in a raw HID report that the Bluetooth module sends over the Bluetooth link to the host. The host driver software decodes the raw HID report and passes the key values to the application running on the PC. [Figure 5-1](#) shows some typical HID environments.

FIGURE 5-1: TYPICAL HID ENVIRONMENTS

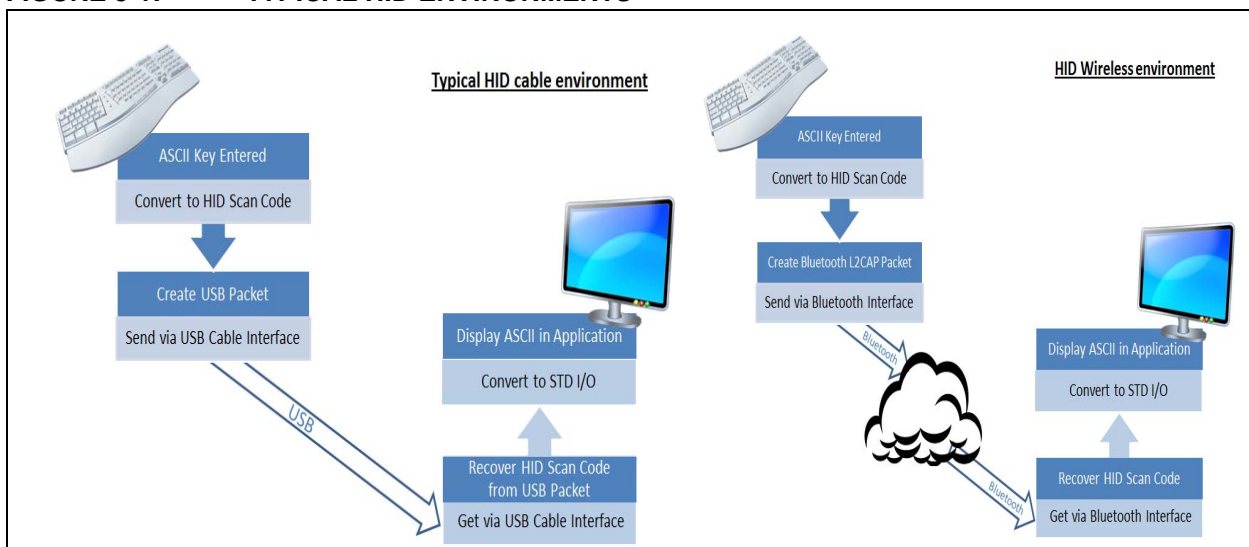

The type of HID device, such as a keyboard, mouse, or joystick, is defined by the HID descriptor in the raw HID report.

5.2 HID FIRMWARE OVERVIEW

To use Roving Networks' Bluetooth HID profile, you must use a special build of firmware, version 6.03 or later.

Note: Roving Networks modules shipped with firmware version 6.11 and higher support the HID profile. You do not need special firmware if your module is running firmware 6.11 or higher.

5.2.1 Operational Modes

Roving Networks Bluetooth modules operate in two modes: data mode (default) and command mode. While in data mode, the module is essentially a data pipe. When the module receives data, it strips the Bluetooth headers and trailers and passes the user data to the UART. When data is written to the UART, the module constructs the Bluetooth packet and sends it out over the Bluetooth connection. Thus, the entire process of sending/receiving data to the host is transparent to the end microprocessor.

You configure the module by putting it into command mode and sending ASCII commands over a serial port or the Bluetooth link. Once you change the configuration parameters, they persist until changed or you perform a factory reset. You enter command mode by opening a terminal emulator and sending the string \$\$\$ to the module. You can connect to the module remotely over Bluetooth or via a computer. When you send \$\$\$ the module returns `CMD`, indicating that it is in command mode.

Once the module is in command mode, you can send configuration commands to it via the terminal. When you enter a valid command, the module returns `AOK`. It returns `ERR` for an invalid command and `?` for unrecognized commands. Type `H<cr>` to see a list of commands, and `D<cr>` to view a summary of the module's current settings. To return to data mode, type `---<cr>` or reset the device and re-connect.

5.2.2 Profile Configuration

The HID firmware supports Bluetooth HID and SPP. You switch between these profiles using ASCII commands. In firmware version 6.10 and higher, the SPP profile is enabled by default. To switch between HID and SPP, use the following commands:

```
S~,0 // Enables SPP protocol
R,1 // Reboot to use SPP
```

To switch back to HID, use the following command:

```
S~,6 // Enables HID profile
R,1 // Reboot to use HID profile
```

5.2.3 Device Discovery & Pairing

During pairing, the module determines the HID device type. As part of the Bluetooth protocol, the HID device sends the type. By default, the Roving Networks' modules running the HID profile are discoverable as a keyboard. You can change the device type by setting the descriptor type using the HID flags register.

After first pairing the host to a device with the Bluetooth HID module, the host initiates a connection. However, if the initial connection is broken, as the case when the power is cycled, the device must re-connect to the host. (The host will not initiate a connection.)

Using DTR mode 4 (default) or pairing mode 6 allows the module to auto-connect back to the last paired host. Alternatively, you can reconnect by sending the `c` command from command mode. See the following examples:

```
SM, 4 // Use GPIO6 to make and break
      // connections

SM, 6 // Automatically make connections
      // without using GPIO6
```

5.2.4 HID Flag Register

The HID flag register is a bit-mapped register that is configured while in command mode. To set the register, use the `SH, <value>` command, where `<value>` is a 4-character hex word. The `GH` command returns the current value of the register. The default factory setting is `0000`, which corresponds to a keyboard. [Table 5-1](#) shows the HID flag register bits; currently only the lower 9 bits are defined.

TABLE 5-1: HID FLAG REGISTER BITS

9	8	7..4	3	2..0
Force HID mode if GPIO11 is high on power-up.	Toggle virtual keyboard on iOS when first connected.	Descriptor type: 0000 = Keyboard 0001 = Game Pad 0010 = Mouse 0011 = COMBO 0100 = JOYSTICK 1XXX = Reserved	Send output reports over UART.	Indicates number of paired devices to which the module can reconnect.

5.2.4.1 BIT 9

Bit 9 is an enable bit that overrides the profile selection mode. When this bit is set, the firmware checks the level of GPIO11 on power up; if it is high, the module switches to HID mode. With this bit, you can set the module's default profile to SPP mode, allowing SPP and remote configuration (for example from Bluetooth clients with SPP). Then, you can use GPIO11 to override SPP mode and enable HID mode.

Note: GPIO11 HID profile switching is disabled when the module is configured for the MDM SPP profile (`s~`, 3). GPIO11 is reserved for RTS in MDM SPP mode.

5.2.4.2 BIT 8

Bit 8 enables the toggling of the virtual keyboard on iOS devices.

5.2.4.3 BITS 7-4

Bits 7 through 4 control the following settings:

- The COD that is advertised by the module.
- The HID report descriptor and the available reports.

5.2.4.4 BIT 3

Bit 3 enables output reports, which are sent by the host to the device over Bluetooth to the UART. These reports are a feedback mechanism to the embedded microcontroller. The output record is formatted as:

```
<start> <number of bytes> <report>
0xFE 1 - 8 data
```

For example, the HID keyboard output reports the keyboard LED status as:

```
0xFE 0x2 0x1 <LED status byte>
```

5.2.4.5 BITS 2-0

Bits 2 through 0 define the number of paired hosts to which the module attempts to reconnect after power up. After each successful pairing, the link key is stored in the Bluetooth module. Up to eight paired link keys are stored in FIFO fashion. Upon power up, the module tries to connect to the most recently paired device. If it is not found, the module attempts to connect to the next *N* hosts depending upon the settings of bits 2-0 in the HID register.

For example:

- To set the device as a mouse, use **SH,0220**.
- To set the device as a combo mouse, use **SH,0230**.

5.3 HID REPORTS

The module interprets input on the UART and generates an HID report that is sent over the Bluetooth link to the host. Input to the module is interpreted as shown in [Table 5-2](#)

TABLE 5-2: DATA INTERPRETATION

Binary Input	Function
0	Disconnect if connected from the host.
0x1 - 0xF	Converted to special keys like home, page up, backspace, etc.
0x10 - 0x7E	Translation mode: printable ASCII characters.
0x7F	Toggle virtual keyboard on iPhone.
0x80 - 0xDF	Interprets input as actual scan code.
0xE0 - 0xE7	Sends modifier keys Left Shift, Left Alt, Right Shift, etc.
0xE8 - 0xEF	Interprets input as actual scan code.
0xF0 - 0xFC	Reserved for custom reports.
0xFD	Raw mode: input is RAW report.
0xFE	Interpretive mode: input is shorthand report.
0xFF	Sends output report to UART.

See “[Scan Code Tables: UART \(ASCII\) to HID Report](#)” on page 67 for a complete table of UART input to HID report.

5.3.1 Translation Mode

Translation mode is the simplest way to send HID reports for printable ASCII characters. When the Bluetooth module's UART receives a printable ASCII value, it is converted into a keyboard raw HID report. Two reports are sent for each character; the first report indicates that the key is pressed and the second indicates that it is released. For example:

a is translated into:

0xFD	0x9	0x1	0x0	0x04	0x0	0x0	0x0	0x0	0x0	0x0	0x0	0x0	0x0	<i>Key Press</i>
------	-----	-----	-----	------	-----	-----	-----	-----	-----	-----	-----	-----	-----	------------------

0xFD	0x9	0x1	0x0	0x00	0x0	0x0	0x0	0x0	0x0	0x0	0x0	0x0	0x0	<i>Key Release</i>
------	-----	-----	-----	------	-----	-----	-----	-----	-----	-----	-----	-----	-----	--------------------

A is translated into:

0xFD	0x9	0x1	0x2	0x0	0x04	0x0	0x0	0x0	0x0	0x0	0x0	0x0	0x0	<i>Key Press</i>
------	-----	-----	-----	-----	------	-----	-----	-----	-----	-----	-----	-----	-----	------------------

0xFD	0x9	0x1	0x0	0x00	0x00	0x0	0x0	0x0	0x0	0x0	0x0	0x0	0x0	<i>Key Release</i>
------	-----	-----	-----	------	------	-----	-----	-----	-----	-----	-----	-----	-----	--------------------

Notice that the scan code for A is the same as the previous raw report except the modifier byte indicates the left Shift key is pressed. If multiple scan codes are sent, the modifier applies to all of them.

5.3.2 Keyboard Shorthand Mode

The Roving Networks HID profile supports shorthand for implementing keyboards. The advantage of this mode is that multiple keyboard keys can be sent with minimal characters over the UART, which optimizes bandwidth because the module does not have to send a keyboard report. Shorthand reports start with 0xFE and have variable length. The shorthand format is:

0xFE	Length	Modifier	Scan Code 1	Scan Code 2	Scan Code 3	Scan Code 4	Scan Code 5	Scan Code 6
------	--------	----------	-------------	-------------	-------------	-------------	-------------	-------------

where Length = 0, 2, 3, 4, 5, 6, or 7, depending on how many keys are sent.

For example, shorthand for the **a**, **b**, and **c** keys is:

0xFE	0x3	0x0	0x4	0x05	0x06
------	-----	-----	-----	------	------

The Bluetooth module converts this shorthand into the following raw HID reports that are sent over the Bluetooth link:

0x9	0x1	0x0	0x04	0x5	0x6	0x0	0x0	0x0	0x0	0x0	0x0
-----	-----	-----	------	-----	-----	-----	-----	-----	-----	-----	-----

Shorthand to release all three keys is:

0xFE	0x0
------	-----

5.3.3 Raw Report Mode

The start byte 0xFD indicates a raw HID report. In the Bluetooth module, the start byte is stripped and the following bytes are sent without interpretation. The Raw HID report consists of a start byte, length, descriptor type (which defines the type of HID device), and data specified in scan codes or encoded values. The format of the data depends on the descriptor type. HID reports are sent one report at a time.

The raw report format is:

Start (1Byte)	Length (1 Byte)	Descriptor (1 Byte)	Data Length – One Byte for the Descriptor
------------------	--------------------	------------------------	--

The keyboard report format is:

0xFD	9	1	Modifier	0x00	Scan Code 1	Scan Code 2	Scan Code 3	Scan Code 4	Scan Code 5	Scan Code 6
------	---	---	----------	------	-------------	-------------	-------------	-------------	-------------	-------------

The modifier byte is a bit mask interpreted as shown below. For example, you can use 0x2 or 0x20 to turn a lower case **a** into an upper case **A**.

Bit 7	Bit 6	Bit 5	Bit 4	Bit 3	Bit 2	Bit 1	Bit 0
Right GUI	Right Alt	Right Shift	Right Ctrl	Left GUI	Left Alt	Left Shift	Left Ctrl

The mouse raw report format is:

0xFD	5	2	Buttons	X-stop	Y-stop	Wheel
------	---	---	---------	--------	--------	-------

The consumer report format in keyboard or combo mode is:

0xFD	3	3	Data Byte	Data Byte
------	---	---	-----------	-----------

The joystick and gamepad format is:

0xFD	6	Buttons 0 - 7	Buttons 8 - 15	X1 Note 1	Y1 Note 1	X2 Note 1	Y2 Note 1
------	---	------------------	-------------------	--------------	--------------	--------------	--------------

Note 1: The range of X and Y is -127 to 127.

In combo mode, it is possible to send both for a keyboard and mouse HID reports. In this case, if you wanted to enter an **A** and move the mouse you can use either of the following methods:

A:

0xFD	0x5	0x2	0x0	0x1	0x20	0x20	0x20
------	-----	-----	-----	-----	------	------	------

or

0xFD	0x9	0x1	0x2	0x0	0x04	0x0	0x0	0x0	0x0	0x0	0x0	0x0	0x0
------	-----	-----	-----	-----	------	-----	-----	-----	-----	-----	-----	-----	-----

0xFD	0x5	0x2	0x0	0x1	0x20	0x20	0x20
------	-----	-----	-----	-----	------	------	------

5.3.4 Special Reports & Modes

This section describes special modes and reports, including output reports, virtual keyboards, a key-map register, etc.

5.3.4.1 OUTPUT REPORTS

Because the host controls the modifier keys' state, the HID device must be able to request the current status. The output report code 0xFF is reserved to return the current status of the Caps Lock, Num Lock, and Scroll Lock keys over the UART. Because a HID device can only toggle these keys, it tells the device the state of the keys. This functionality is particularly useful when multiple HID devices are in the system and the Bluetooth device needs to update the state of these keys. The format is sent as:

0xFF	Status Byte
------	-------------

Table 5-3 shows the status byte definitions.

TABLE 5-3: STATUS BYTE DEFINITIONS

Key	Status Bit
Num Lock	1
Caps Lock	2
Scroll Lock	4

5.3.4.2 APPLE VIRTUAL KEYBOARD

When the module is connected to an iOS device, the virtual keyboard is hidden. However, in some applications it is useful or required to display the keyboard for data entry on the touch screen of the iOS device. Toggling GPIO9 displays or hides the virtual keyboard. GPIO9 must go from low to high for at least 200 ms for the toggle to occur.

Note: The virtual keyboard toggle must be enabled in the HID flag register for this feature to work.

5.3.4.3 KEY MAP REGISTER

This register allows you to replace any ASCII code with another ASCII code. It is useful in cases where you want to toggle special keys that the device cannot generate. For example, the touch keyboard on an iOS device is 0x7F, but the device cannot generate 0x7F.

If the register is non-zero, the upper byte is the key to replace, and the lower is the replacement. The command to set the register is `S=, <value>`, where `<value>` is a 4-character hex word. To obtain the current value of the register, use the `G=` command. (The value also shows up in the advanced settings using the `E` command.) The default factory setting is 0000 (not enabled).

For example, to use the tilde (~), which is 0xfe, to toggle the keyboard, enter the command `S=, 7e7E`.

5.3.4.4 DISCONNECT KEY

A special hex key value 0x00 (zero) causes a Bluetooth disconnect, which allows you to control the connection by sending a single key. To disconnect, send 0x0.

Combining the disconnect feature with the key map register, any key can be used as a disconnect key. For example to set the capital Z key (hex 5A) as the disconnect key, use the following command:

```
S=, 5A00 // Map Z key as the disconnect key
```

5.3.4.5 CONSUMER REPORT

You can use a HID raw report to send additional keys as a consumer report. The format is:

0xFD	3	3	Low Byte	High Byte
------	---	---	----------	-----------

Table 5-4 shows the data byte format.

TABLE 5-4: DATA BYTE FORMAT

Consumer Key Function	Report Bit
AC Home	0x1
AL Email Reader	0x2
AC Search	0x4
AL Keyboard Layout (Virtual Apple Keyboard Toggle)	0x8
Volume Up	0x10
Volume Down	0x20
Mute	0x40
Play/Pause	0x80
Scan Next Track	0x100
Scan Previous Track	0x200
Stop	0x400
Eject	0x800
Fast Forward	0x1000
Rewind	0x2000
Stop/Eject	0x4000
AL Internet Browser	0x8000

For example, to raise the volume, send:

0xFD	0x03	0x03	0x10	0x00
------	------	------	------	------

To release the key, send:

0xFD	0x03	0x03	0x00	0x00
------	------	------	------	------

5.3.4.6 SCAN CODE TABLES: UART (ASCII) TO HID REPORT

Table 5-5 shows the UART-to HID input conversion.

TABLE 5-5: UART-TO-HID SCAN CODE

UART Input	HID Code	HID Function
0	NA	Disconnect if Connected
1	0x49	Insert
2	0x4A	Home
3	0x4B	Page up
4	0x4C	delete
5	0x4D	end
6	0x4E	Page down
7	0x4F	Right arrow
8	0x2A	Backspace
9	0x2B	TAB
10	0x28	Enter
11	0x50	Left arrow
12	0x51	Down arrow
13	0x28	Enter
14	0x52	Up arrow
15-26	0x3A-45	F1 - F12
27	0x29	Escape
28	0x39	Caps lock
29	0x47	Scroll lock
30	0x48	Break-pause
31	0x53	Num lock
32-126		Printable ASCII characters
127	0x65	Toggle iPhone virtual keyboard
0x80-0xDF	0x80-0xDF	Sends actual scan code
0xE0	0xE0	Left Control
0xE1	0xE1	Left Shift
0xE2	0xE2	Left Alt
0xE3	0xE3	Left GUI
0xE4	0xE4	Right Control
0xE5	0xE5	Right Shift
0xE6	0xE6	Right Alt
0xE7	0xE7	Right GUI
0xE8-0xEF	0xE8-0xEF	Sends actual scan code
0xF0-0xFC	Reserved for future use	Custom reports
0xFD		Raw report
0xFE		Shorthand report
0xFF		Sends output report to UART

Table 5-6 shows the ASCII to HID report scan codes.

TABLE 5-6: ASCII TO HID REPORT (TO HOST) SCAN CODES

ASCII	Code	ASCII	Code	ASCII	Code	ASCII	Code
System Power	81	m M	10	6 ^	23	. >	37
System Sleep	82	n N	11	7 &	24	/ ?	38
System Wake	83	o O	12	8 *	25	Caps Lock	39
No Event	00	p P	13	9 (26	F1	3A
Overrun Error	01	q Q	14	0)	27	F2	3B
POST Fail	02	r R	15	Return	28	F3	3C
ErrorUndefined	03	s S	16	Escape	29	F4	3D
a A	04	t T	17	Backspace	2A	F5	3E
b B	05	u U	18	Tab	2B	F6	3F
c C	06	v V	19	Space	2C	F7	40
d D	07	w W	1A	- _	2D	F8	41
e E	08	x X	1B	= +	2E	F9	42
f F	09	y Y	1C	[{	2F	F10	43
g G	0A	z Z	1D] }	30	F11	44
h H	0B	1 !	1E	\	31	F12	45
i I	0C	2 @	1F	Europe 1	32	Print Screen	46
j J	0D	3 #	20	; :	33	Scroll Lock	47
k K	0E	4 \$	21	' "	34	Break (Ctrl-Pause)	48
l L	0F	5 %	22	, <	36	Pause	48

5.4 HID REFERENCES

[1] Bluetooth SIG, Human Interface Profile Overview

URL: <https://www.bluetooth.org/Building/HowTechnologyWorks/ProfilesAndProtocols/HID.htm>

[2] USB.org, HID Usage Tables

URL: http://www.usb.org/developers/devclass_docs/Hut1_12v2.pdf

[3] USB.org, HID Technology

URL: <http://www.usb.org/developers/hidpage/>

Appendix A. Factory Defaults

Table A-1 shows the factory default settings.

Note: Restoring the device to the factory default values resets all values to the defaults shown in Table A-1.

TABLE A-1: FACTORY DEFAULT SETTINGS

Setting	Default Value
Bluetooth Service Profile	Serial Port Profile (SPP)
Device Mode	4 (DTR)
Baud Rate	115,200 bps
Parity	None
Data Bits	8 Bits
Stop Bits	1 Bit
Power Mode	Auto Low-Power Discoverable Mode
Device Name (Local Name)	FireFly-xxxx (last 2 bytes of the Bluetooth Address)
Service Class	SPP
Service Type	0000 (Undefined Service Type)
Class of Device (COD)	0x1F00 (Unknown Device Type)
Authentication	Keyboard I/O simple secure pairing (SPP)
Discovery Enabled	0x0100 Window, Fixed Interval of 0x1000
Connection Enabled	0x0100 window, Fixed Interval of 0x1000
Bonding	Disabled
Configuration Timer	60 seconds
Sniff Mode	Disabled
Default Pin	1234
Hide Pin Code	0, Disabled
Local Echo of RX Characters in Command Mode	OFF
Power	0010 (Maximum Power)

NOTES:

Appendix B. Command Quick Reference Guide

This section provides a quick reference of the firmware commands as well as the factory defaults. [Table B-1](#) provides an overview of the set commands.

TABLE B-1: SET COMMANDS

Command	Description	Factory Settings
S7, <1,0>	7-Bit Data Mode Enable/Disable.	0, Disabled
SA, <0,1,2,4>	Authentication Enable/Disable.	0, Disabled
SB, <value>	Send Break.	Not Applicable
SC, <value>	Service Class.	0x0000, Unknown
SD, <value>	Device Class.	0x1F00, Undefined
SE, <string>	Sets the UUID for SPP Data Connections.	0x1101
SF, 1	Factory Defaults.	N/A
SH, <value>	Sets the HID flag register (HID firmware only).	0200
SI, <hex value>	Inquiry Scan Window.	0x0100
SJ, <hex value>	Page Scan Window.	0x0100
SL, <E,O,N>	Parity.	N, None
SM, <0,1,2,3,4,5>	Mode (0 = Slave, 1 = Master, 2 = Trigger, 3 = Auto, 4 = DTR, 5 = Any).	4, DTR
SN, <string>	Name.	FireFly-xxxx
SO, <string>	Connect/Disconnect Status String.	NULL, No Status String
SP, <string>	Pin Code.	1234
SQ, <mask>	Special Configuration Settings.	0
SR, <hex value>	Remote Address (Use SR, Z to Remove).	None Set
SS, <string>	Service Name.	SPP
ST, <value>	Configuration Timer.	60 Seconds
SU, <value>	Baud Rate.	115 K
SW, <value>	Sniff Rate.	0x0000, Disabled
SX, <1,0>	Bonding.	0, Disabled
SY, <hex value>	Power Setting.	0010
SZ, <value>	Raw Baud Rate.	N/A
S , <value>	Low-Power Connection Mode.	0000
S~, <0, 1, 2, 3, 4, 5, 6>	Profile Setting (0 = SPP, 1 = DUN-DCE, 2 = DUN-DTE, 3 = MDM SPP, 4 = DUN-DCE & SPP, 5 = APL, and 6 = HID).	0, SPP
S-, <string>	Sets the Serialized Friendly Name of the Device.	N/A
S?, <0,1>	Enable/Disable Role Switch.	0, Disabled
S\$, <string>	Configuration Detection Character.	\$\$\$

Table B-2 describes the get (or display) commands.

TABLE B-2: GET (DISPLAY) COMMANDS

Command	Description
D	Basic Settings.
E	Extended Settings.
G<string>	Displays Setting for a Set Command Indicated by <string>.
GB	Bluetooth Address.
GK	Connection Status.
GF	Bluetooth Address of Currently or Most Recently Connected Active Remote Device.
GR	Remote Address.
G&	I/O Ports.
H	Help.
M	Remote Modem Signal Status.
O	Other Settings.
V	Firmware Version.

Table B-3 describes the action commands.

TABLE B-3: ACTION COMMANDS (PART 1 OF 2)

Command	Description
\$\$\$	Enter Command Mode.
---	Exit Command Mode.
+	Toggle the Local Echo of RX Characters in Command Mode.
&	Return the Dipswitch Values.
C	Connect Immediately to the Stored Remote Address.
C, <address>	Connect to Address.
CF<address>	Connect to Address in Fast Mode.
CFI	Connect and Immediately Go into Fast Data Mode Using Last Address Found.
CFR	Connect to Stored Remote Address in Fast Mode.
CT<address>, <value>	Connect, Address Required, Optional Disconnect Timer in ¼ Seconds.
F, 1	Enter Fast Data Mode, End Configuration Immediately.
I, <value>, <COD>	Device Scan Inquiry, Time in Seconds, Optional COD Filter (0 = All).
IN<value>, <COD>	Device Scan Inquiry, Returns NAMEs.
IQ	Scans for Devices and Returns their RSSI.
IS<value>	Device Scan Inquiry, Fixed COD (0x001F00) to Find Roving Networks Devices.
IR<value>	Device Scan Inquiry, Fixed COD (0x0055AA) to Find Instant Cable Pairs.
J	Hides the Device's Pin Code.
K,	Kill (Disconnect) from Current Connection.
L	Toggle Link Quality Readings.
P, <char>	Pass through Any Character up to a Carriage Return or Line Feed.
Q	Quiet, Turn off Discovery and Connectability.
R, 1	Reboot.
T, <0,1>	Pass Received Data (from UART or Bluetooth) while in Command Mode.

TABLE B-3: ACTION COMMANDS (PART 2 OF 2)

Command	Description
U, <value>, <E,O,N>	Temporary UART Change.
W	Re-Enable Discovery and Connectability.
Z	Enter Low-Power Sleep Mode.

Table B-4 describes the GPIO commands.

TABLE B-4: GPIO COMMANDS

Command	DESCRIPTION
S@, <hex value>	Set the GPIO pin's direction (input or output). This setting is lost when power is cycled.
S&, <hex value>	Set the GPIO pin's value. This setting is lost when power is cycled.
S%, <hex value>	Store the GPIO pin's direction for use on power up.
S^, <hex value>	Store the GPIO pin's powerup value.
S*, <hex value>	Set values for GPIO8, GPIO9, GPIO10, and GPIO11.

NOTES:

Appendix C. Firmware Revision History

The following sections provide the firmware revision history.

C.1 VERSION 6.15 (3/26/2013)

This firmware replaces version 4.77. Designers are encouraged to create all new designs based on firmware version 6.15 and higher.

- The following commands that were changed or deprecated in version 6.11 have been restored in 6.15 to maintain backwards compatibility (command level) with firmware version 4.77.
 - `L`—This command displays the minimum and maximum RSSI values.
 - `Q`—Places the module in a non-discoverable mode (same as `Q, 1` in firmware 6.12)
 - `W`—wakes up module (same as `Q, 0` in firmware 6.12)
- Changes to commands available in firmware 6.12:
 - `Q, ?` displays the current quiet mode (in firmware 6.12, you use the `Q` command to display the mode).
 - `SE, (0,1)` are null commands in firmware 6.15 to maintain compatibility with firmware 4.77 command syntax.
- Inquiry and Page scan defaults to 0x0100 for compatibility with firmware 4.77. In firmware 6.11/6.12, the page interval was set to 0x0060.

C.2 VERSION 6.12 (LIMITED RELEASE)

- Incorporates the HID profile into the standard firmware.
- Added the `J` command to hide the device's pin code. This command replaces the `SV, 1` command (hide or show the pin code).
- Updated the `IQ` command to include RSSI inquiry scanning.

C.3 VERSION 6.11

No new features. Improved code to make it more maintainable.
Inquiry and page interval set to 0x0060.

C.4 VERSION 6.10

- Added additional functionality to the `Q` command to enable/disable device discovery and ability to connect.
- Added authentication modes: open mode, keyboard mode, SSP mode, and pin code mode.
- Encryption is enabled by default and cannot be disabled.
- Added the ability to store a custom UUID in the device.

C.4.1 HID Firmware Known Issues

- The HID firmware has difficulty maintaining a connection with the first generation iPad running iOS version 4.4; you must upgrade to iOS version 5 to use the iPad with the HID firmware.
- The HID profile does not appear to work with BlueSoleil.

C.5 VERSION 4.77 (8/10/2009)

- Fixed issue where disconnect followed by a fast reconnect (< 100 ms) would cause the module to go (deaf) making it undiscoverable or connectable, requiring a reset.
- Fixed issue where <cr><lf> characters often were sent out the UART when entering fast data mode using the F, 1 command remotely.
- Added the S | command to reduce power while waiting for a connection.
- Added CF, CFI, and CFR commands for fast data mode connections.
- Added L command to display link quality.
- Added + command to toggle local echo of characters in command mode.

C.6 VERSION 4.74 (3/7/2009)

- Added support for SPP and DUN simultaneous profile appearance.

Appendix D. Document Information

CONVENTIONS USED IN THIS GUIDE

This manual uses the following documentation conventions:

DOCUMENTATION CONVENTIONS

Description	Represents	Examples
Arial font:		
Italic characters	Referenced books	<i>MPLAB[®] IDE User's Guide</i>
	Emphasized text	...is the <i>only</i> compiler...
Initial caps	A window	the Output window
	A dialog	the Settings dialog
	A menu selection	select Enable Programmer
Quotes	A field name in a window or dialog	"Save project before build"
Underlined, italic text with right angle bracket	A menu path	<u><i>File>Save</i></u>
Bold characters	A dialog button	Click OK
	A tab	Click the Power tab
N'Rnnnn	A number in verilog format, where N is the total number of digits, R is the radix and n is a digit.	4'b0010, 2'hF1
Text in angle brackets < >	A key on the keyboard	Press <Enter>, <F1>
Courier New font:		
Plain Courier New	Sample source code	#define START
	Filenames	autoexec.bat
	File paths	c:\mcc18\h
	Keywords	_asm, _endasm, static
	Command-line options	-Opa+, -Opa-
	Bit values	0, 1
	Constants	0xFF, 'A'
Italic Courier New	A variable argument	<i>file.o</i> , where <i>file</i> can be any valid filename
Square brackets []	Optional arguments	mcc18 [options] <i>file</i> [options]
Curly braces and pipe character: { }	Choice of mutually exclusive arguments; an OR selection	errorlevel {0 1}
Ellipses...	Replaces repeated text	var_name [, var_name...]
	Represents code supplied by user	void main (void) { ... }

RECOMMENDED READING

This user's guide describes how to configure Roving Networks Bluetooth data modules. The module-specific data sheets contain current information on the module hardware specifications. Other useful documents are listed below. The following documents are available and recommended as supplemental reference resources:

RN41/41N Class 1 Bluetooth Module Data Sheet

This data sheet provides detailed specifications for the RN41/41N module.

RN42/42N Class 2 Bluetooth Module Data Sheet

This data sheet provides detailed specifications for the RN42/42N module.

To obtain any of these documents, visit the Roving Networks web site at www.rovingnetworks.com.

DOCUMENT REVISION HISTORY

Revision 1.0r (March 2012)

This is the initial released version of the document.

Index

Numerics

7-bit data mode 50

A

action command

- 32
- & 32
- + 32
- \$\$\$ 32
- C 32
- C, 33
- CF, 33
- CFI 33
- CFR 33
- CT,, 33
- F,1 34
- H 34
- I,, 34
- IN, 34
- IR 35
- IS 35
- L 35
- M 35
- O 36
- P, 36
- Q 36
- R,1 36
- T, 36
- U,, 37
- V 37
- W 37
- Z 37

action commands 72

Android phones 49

APL 46

auto-connect 11

auto-connect ANY mode 10

auto-connect DTR mode 10

auto-connect master mode 10

auto-connection 52

auto-discovery pairing 11

auto-pairing 52

B

baud rate 11

Bluetooth

- configuration 7
- connection 12, 15
- discovery 13
- pairing 13
- profiles 60

boot-up, timing 69

C

C, 33

cable replacement 57

- using hardware 57
- using software 57

CF, 33

COM port, changing 50

command

- action 72
- get 72
- quick reference 71
- set 71

command mode 6, 60

- entering 8

command syntax 19

commands

- action 32
- change 32
- get 31
- GPIO 32, 73
- set 19

common issues 50

computer

- pairing 15

configuration 11

- local 7
- over Bluetooth 7
- profile 60
- remote 7
- serial adapter 52
- timer settings 44
- using GPIO 11

connecting 15

connection

- auto 52
- changing COM port 50
- example 51
- issues connecting 50
- making 12
- status 48
- to multiple modules from 1 client 51

controlling modem 47

CT,, 33

Customer Support 78

D

data mode 6, 60

DB9 pins 52

deep sleep 42

default

- pin code 17

default configuration 6

defaults, factory 69

- design concerns 47
- device reboot 36
- dipswitch 54
- dipswitch settings 54
- dipswitches 11, 55
- disable output drivers 41
- disabling output drivers 43
- discovery 13
 - example 51
 - HID profile 60
- DUN-DCE 46
- DUN-DTE 46
- E**
- enable deep sleep 41
- evaluation boards 5
- example
 - discovery and connection 51
- F**
- factory defaults 69
- factory reset 11, 47
- firmware 75
 - fixes 75, 77
 - HID profile 60
 - release notes 75, 77
- firmware version 37
- flag register bits 61
- flow control 53
- flow control jumpers 53
- G**
- get
 - D 31
 - E 31
 - G 32
 - G& 31
 - GB 31
 - GF 31
 - GK 31
 - GR 31
- get commands 72
- GPIO assignments 12
- GPIO command
 - S^ 38
 - S@ 37
 - S* 38
 - S& 38
 - S% 38
- GPIO commands 37
- GPIO pin power-up values 38
- GPIO pins 11, 47
- GPIO10 12, 39
- GPIO11 12, 39
- GPIO2 12, 48
- GPIO3 12

- GPIO4 12, 47
- GPIO5 12, 48
- GPIO6 12
- GPIO7 12
- GPIO8 12, 39
- GPIO9 12, 39
- green LED 49
- H**
- hardware connections 48
- hardware pairing 57
- hardware signals 47
- HCI mode 45
 - HCI over UART 46
 - HCI over USB 46
- HID 46
- HID profile
 - discovery and pairing 60
 - fag register 61
 - firmware 60
 - reports 62
 - translation 63
 - typical uses 59
- I**
- I, 34
- IN, 34
- instant cable replacement 57
- IR 35
- IS 35
- J**
- jumpers 53
- jumpers, flow control 53
- K**
- K, 35
- kill command 35
- L**
- latency, optimizing for 49
- LED
 - status 49
- local configuration 7
- lower transmit power 41
- lowering transmit power 41
- low-power mode 41
- M**
- managing power 41
- master mode 10
- MDM SPP 46
- microprocessor
 - interfacing with 45
- mode
 - 7-bit data 50
 - auto-connect ANY 10

auto-connect DTR.....	10
auto-connect master.....	10
command.....	6, 60
data.....	6, 60
HCI.....	45
master.....	10
security.....	17
slave.....	10
trigger.....	10
modem control.....	47
modes.....	60
N	
null model jumpers.....	53
null modem.....	53
O	
operating modes	
mode	
operating.....	10
operational modes.....	60
optimizations.....	49
optimize inquiry and page window.....	41
P	
pairing.....	13
auto.....	52
hardware.....	57
HID profile.....	60
software.....	57
with computer.....	15
with smartphone.....	15
pairing mode	
mode	
pairing.....	10
pin code, default.....	17
power.....	48
power consumption, reducing.....	41
power management.....	41
power setting.....	43
power settings.....	27
profile	
APL.....	46
configuration.....	60
DUN-DCE.....	46
DUN-DTE.....	46
MDM SPP.....	46
override.....	61
settings.....	46
SPP.....	46
profile values.....	29
profile	
HID.....	46
Q	
quick reference.....	71

R	
Reading, Recommended.....	78
reference designs.....	5
release notes.....	75, 77
replacement, cable.....	57
reports.....	62
reset circuit.....	47
revision history.....	75
S	
security modes.....	17
serial adapter configuration.....	52
serial cable	
configuration.....	7
set	
S-,.....	29
S?,.....	30
S ,.....	30
S\$,.....	30
S7,.....	19
SA,.....	19
SB,.....	20
SC,.....	20
SD,.....	21
SE,.....	21
SF, 1.....	22
SH,.....	22
SI,.....	23
SJ,.....	23
SL,.....	23
SM,.....	24
SN,.....	24
SO,.....	24
SP,.....	25
SQ,.....	25
SR,.....	25
SS,.....	26
ST,.....	26
SU,.....	26
SW,.....	26
SX,.....	27
SY,.....	27
SZ,.....	28
set commands.....	19, 71
setitngs	
dipswitch.....	54
setting	
dipswitches.....	54
power.....	43
setting, switches.....	57
slave mode.....	10
smartphone	
pairing.....	15
sniff mode.....	41, 42
software pairing.....	57

SPI bus	48
SPP	46
switch settings.....	57
switches	11, 54
SY, command	43
T	
throughput, optimizing for	49
timer	
configuration settings	44
used to lower power.....	41
timing values	69
translate HID to ASCII.....	63
transmit power	
deep sleep	42
disabling output drivers.....	43
lowering	43
reducing	41
sniff mode	42
trigger mode.....	10
U	
upgrading	
via SPI	48
USB cable	
configuration	7
using switches.....	11
W	
Warranty Registration	78

