



156.25 MHz LVPECL Oscillator

High Performance Differential MEMS Oscillator

4MA156250Z3

DATASHEET

Features

- Frequency: 156.25 MHz
- Output Type: LVPECL
- Frequency Stability: ± 50 ppm
- Supply Voltage: 2.5V & 3.3V
- Standard Packages: 5.0 x 3.2 mm; 7.0 x 5.0 mm
- RMS phase jitter: 0.5ps typical (12k to 20MHz)
- Operating Temperature: -40 to 85 °C

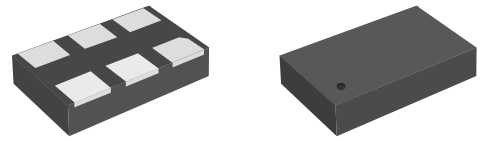

7.0 x 5.0 mm package shown
(also available in 5.0 x 3.2mm pkg)

Specification

Parameter	2.5 V Specifications			3.3 V Specifications			Units	Conditions
	Min	Typ	Max	Min	Typ	Max		
Supply Voltage (V_{DD})	2.375	2.50	2.625	2.97	3.30	3.63	V	
Output Frequency		156.25			156.25		MHz	
Frequency Stability	- 50		+ 50	- 50		+ 50	ppm	Includes supply voltage and temperature variation (-40 to 85°C), reflow drift, and aging.
Supply Current		95			100		mA	No load
Enable/Disable Time			1			1	us	Guaranteed by design
Input LOW level			0.3V _{DD}			0.3V _{DD}	V	At OE pin
Input HIGH level	0.7V _{DD}			0.7V _{DD}			V	At OE pin
Output LOW level		0.8	V _{DD} -1.8		1.5	V _{DD} -1.8	V	
Output HIGH level	V _{DD} -1.0	1.6		V _{DD} -1.1	2.3		V	
Amplitude (V_A)		0.75			0.75		V	Single Ended output swing (Pk-Pk)
Mid Level (V_M)		V _{DD} -1.3			V _{DD} -1.3		V	
Rise Time (T_R)		200	250		170	230	ps	Maximum; 20/80% of V_A ; Output load (CL) = 2pF; Guaranteed by Char.
Fall Time (T_F)		200	250		170	230	ps	Maximum; 20/80% of V_A ; Output load (CL) = 2pF; Guaranteed by Char.
Symmetry (SYM)	48	50	52	48	50	52	%	Worst case; measured at 50% of waveform
Phase Jitter		0.6			0.5		ps	12k to 20MHz, RMS; Measured Differentially
Period Jitter		2.4			2.2		ps	RMS
Cycle-to-Cycle Jitter		18			16		ps	1,000 cycles, Peak
Start-up Time		10			10		ms	Output valid time after power up, 25°C
Aging		± 5			± 5		ppm	25°C, 10 years

Block Diagram

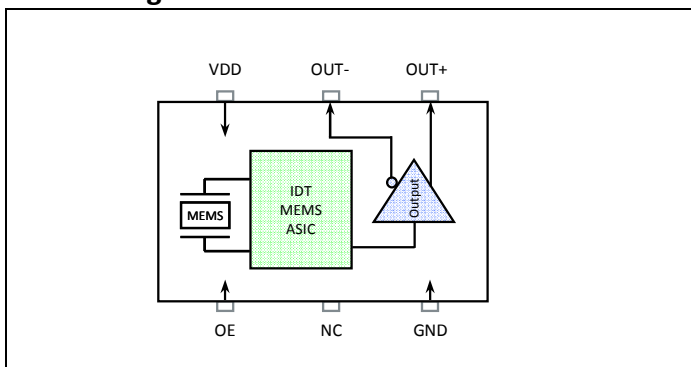

Output Waveform

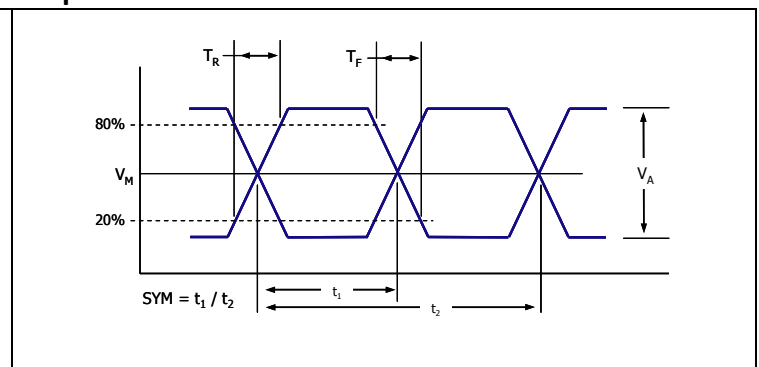

Part Ordering Information

Package Size	Voltage	Ordering Code
7.0 x 5.0 mm	3.3 V	4MA156250Z3AACUGI
	2.5 V	4MA156250Z3BACUGI
5.0 x 3.2 mm	3.3 V	4MA156250Z3AACTGI
	2.5 V	4MA156250Z3BACTGI

* Factory minimum order quantity: 500pcs (T/R)

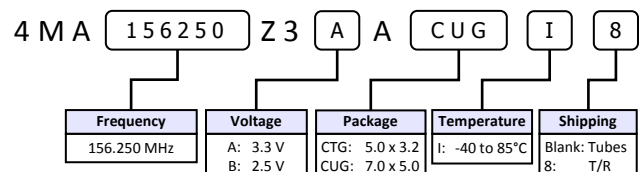

Pin Description

Pin #	Name	Description
1	OE	Output Enable*
2	NC	No Connect
3	GND	Ground
4	OUT+	Output
5	OUT-	Complementary Output
6	VDD	Power Supply Voltage

* Pulled high internally

Solder Reflow Profile

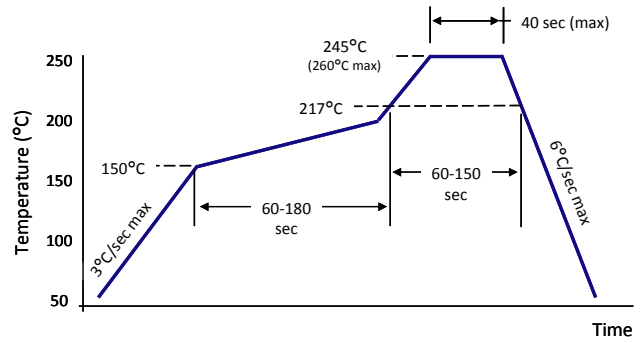

Package Outline and Dimensions

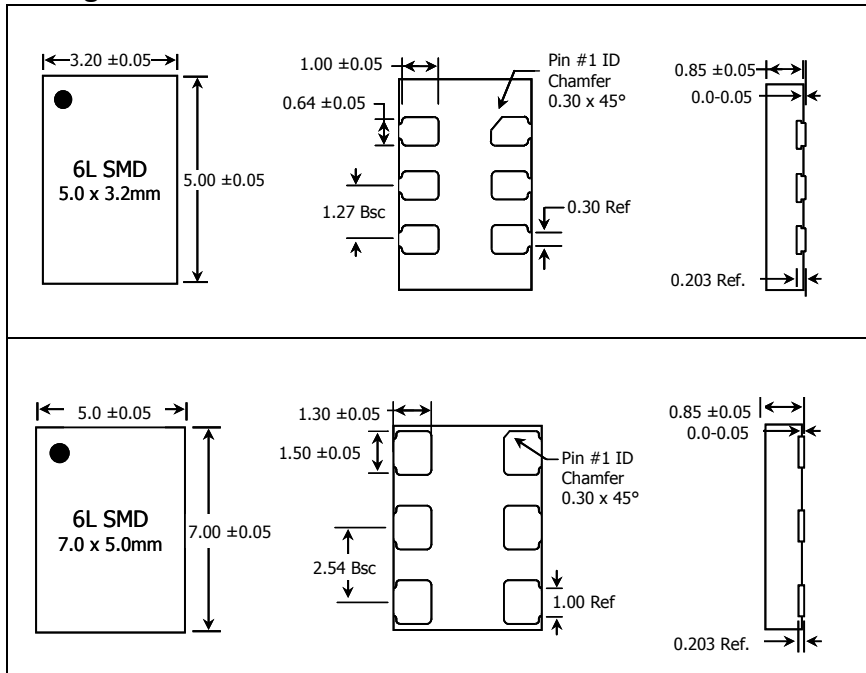

Typical PCB Land Pattern

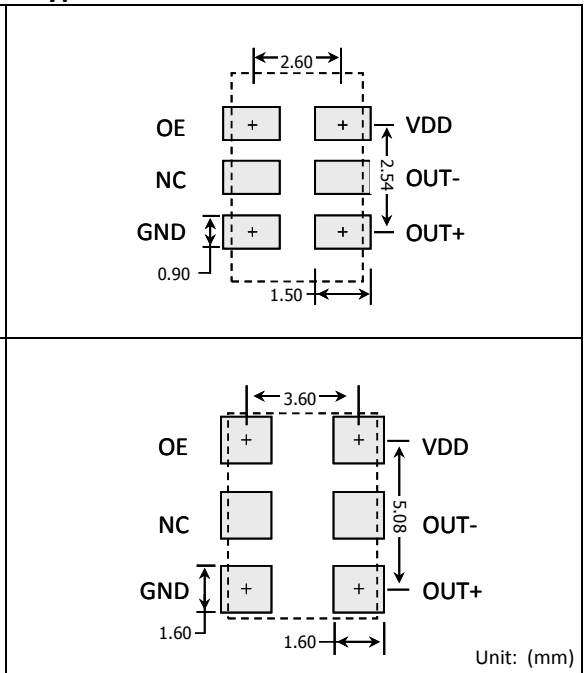

www.IDT.com

6024 Silver Creek Valley Road
San Jose, California 95138

Sales

800-345-7015 (inside USA)
+1 408-284-8200 (outside USA)

Technical Support

MEMS_Support@idt.com
www.idt.com/go/MEMS

DISCLAIMER Integrated Device Technology, Inc. (IDT) and its subsidiaries reserve the right to modify the products and/or specifications described herein at any time and at IDT's sole discretion. All information in this document, including descriptions of product features and performance, is subject to change without notice. Performance specifications and the operating parameters of the described products are determined in the independent state and are not guaranteed to perform the same way when installed in customer products. The information contained herein is provided without representation or warranty of any kind, whether express or implied, including, but not limited to, the suitability of IDT's products for any particular purpose, an implied warranty of merchantability, or non-infringement of the intellectual property rights of others. This document is presented only as a guide and does not convey any license under intellectual property rights of IDT or any third parties. IDT's products are not intended for use in life support systems or similar devices where the failure or malfunction of an IDT product can be reasonably expected to significantly affect the health or safety of users. Anyone using an IDT product in such a manner does so at their own risk, absent an express, written agreement by IDT.

Integrated Device Technology, IDT and the IDT logo are registered trademarks of IDT. Other trademarks and service marks used herein, including protected names, logos and designs, are the property of IDT or their respective third party owners.

Copyright 2010, 2011, 2012. All rights reserved.