

## **2.5MHz 4-, 8-, 10- and 12-Channel Rail-to-Rail Buffers**

The EL5127, EL5227, EL5327, and EL5427 are low power, high voltage rail-to-rail input/output buffers designed for use in reference voltage buffering applications in small LCD displays. They are available in quad (EL5127), octal (EL5227), 10-Channel (EL5327), and 12-Channel (EL5427) topologies. All buffers feature a -3dB bandwidth of 2.5MHz and operate from just 133 $\mu$ A per buffer. This family also features a continuous output drive capability of 30mA (sink and source).

The quad channel EL5127 is available in the 10 Ld MSOP package. The 8-Channel EL5227 is available in both the 20 Ld TSSOP and 24 Ld QFN packages, the 10-Channel EL5327 in the 24 Ld TSSOP and 24 Ld QFN packages, and the 12-Channel EL5427 in the 28 Ld TSSOP and 32 Ld QFN packages. All buffers are specified for operation over the full -40°C to +85°C temperature range.

## **Features**

- 2.5MHz -3dB bandwidth
- Supply voltage = 4.5V to 16.5V
- Low supply current (per buffer) = 133 $\mu$ A
- High slew rate = 2.2V/ $\mu$ s
- Rail-to-rail input/output swing
- Ultra-small packages
- Pb-free plus anneal available (RoHS compliant)

## **Applications**

- TFT-LCD drive circuits
- Electronic games
- Touch-screen displays
- Personal communication devices
- Personal digital assistants (PDAs)
- Portable instrumentation

**Ordering Information**

PART NUMBER	PART MARKING	TAPE & REEL	PACKAGE	PKG. DWG. #
EL5127CY	R	-	10 Ld MSOP (3.0mm)	MDP0043
EL5127CY-T7	R	7"	10 Ld MSOP (3.0mm)	MDP0043
EL5127CY-T13	R	13"	10 Ld MSOP (3.0mm)	MDP0043
EL5127CYZ (Note)	BAAAH	-	10 Ld MSOP (3.0mm) (Pb-Free)	MDP0043
EL5127CYZ-T7 (Note)	BAAAH	7"	10 Ld MSOP (3.0mm) (Pb-Free)	MDP0043
EL5127CYZ-T13 (Note)	BAAAH	13"	10 Ld MSOP (3.0mm) (Pb-Free)	MDP0043
EL5227CL	5227CL	-	24 Ld QFN (4mmx5mm)	MDP0046
EL5227CL-T7	5227CL	7"	24 Ld QFN (4mmx5mm)	MDP0046
EL5227CL-T13	5227CL	13"	24 Ld QFN (4mmx5mm)	MDP0046
EL5227CLZ (Note)	5227CLZ	-	24 Ld QFN (4mmx5mm) (Pb-Free)	MDP0046
EL5227CLZ-T7 (Note)	5227CLZ	7"	24 Ld QFN (4mmx5mm) (Pb-Free)	MDP0046
EL5227CLZ-T13 (Note)	5227CLZ	13"	24 Ld QFN (4mmx5mm) (Pb-Free)	MDP0046
EL5227CR	5227CR	-	20 Ld TSSOP (4.4mm)	MDP0044
EL5227CR-T7	5227CR	7"	20 Ld TSSOP (4.4mm)	MDP0044
EL5227CR-T13	5227CR	13"	20 Ld TSSOP (4.4mm)	MDP0044
EL5227CRZ (Note)	5227CRZ	-	20 Ld TSSOP (4.4mm) (Pb-Free)	M20.173
EL5227CRZ-T7 (Note)	5227CRZ	7"	20 Ld TSSOP (4.4mm) (Pb-Free)	M20.173
EL5227CRZ-T13 (Note)	5227CRZ	13"	20 Ld TSSOP (4.4mm) (Pb-Free)	M20.173
EL5327CL	5327CL	-	24 Ld QFN (4mmx5mm)	MDP0046
EL5327CL-T7	5327CL	7"	24 Ld QFN (4mmx5mm)	MDP0046
EL5327CL-T13	5327CL	13"	24 Ld QFN (4mmx5mm)	MDP0046
EL5327CLZ (Note)	5327CLZ	-	24 Ld QFN (4mmx5mm) (Pb-Free)	MDP0046
EL5327CLZ-T7 (Note)	5327CLZ	7"	24 Ld QFN (4mmx5mm) (Pb-Free)	MDP0046
EL5327CLZ-T13 (Note)	5327CLZ	13"	24 Ld QFN (4mmx5mm) (Pb-Free)	MDP0046
EL5327CR	5327CR	-	24 Ld TSSOP (4.4mm)	MDP0044
EL5327CR-T7	5327CR	7"	24 Ld TSSOP (4.4mm)	MDP0044
EL5327CR-T13	5327CR	13"	24 Ld TSSOP (4.4mm)	MDP0044
EL5327CRZ (Note)	5327CRZ	-	24 Ld TSSOP (4.4mm) (Pb-Free)	MDP0044
EL5327CRZ-T7 (Note)	5327CRZ	7"	24 Ld TSSOP (4.4mm) (Pb-Free)	MDP0044
EL5327CRZ-T13 (Note)	5327CRZ	13"	24 Ld TSSOP (4.4mm) (Pb-Free)	MDP0044
EL5427CL	5427CL	-	32 Ld QFN (5mmx6mm)	MDP0046
EL5427CL-T7	5427CL	7"	32 Ld QFN (5mmx6mm)	MDP0046
EL5427CL-T13	5427CL	13"	32 Ld QFN (5mmx6mm)	MDP0046
EL5427CLZ (Note)	5427CLZ	-	32 Ld QFN (5mmx6mm) (Pb-Free)	MDP0046
EL5427CLZ-T7 (Note)	5427CLZ	7"	32 Ld QFN (5mmx6mm) (Pb-Free)	MDP0046

**Ordering Information** (Continued)

PART NUMBER	PART MARKING	TAPE & REEL	PACKAGE	PKG. DWG. #
EL5427CLZ-T13 (Note)	5427CLZ	13"	32 Ld QFN (5mmx6mm) (Pb-Free)	MDP0046
EL5427CR	5427CR	-	28 Ld TSSOP (4.4mm)	MDP0044
EL5427CR-T13	5427CR	13"	28 Ld TSSOP (4.4mm)	MDP0044
EL5427CRZ (Note)	5427CRZ	-	28 Ld TSSOP (4.4mm) (Pb-Free)	MDP0044
EL5427CRZ-T7 (Note)	5427CRZ	7"	28 Ld TSSOP (4.4mm) (Pb-Free)	MDP0044
EL5427CRZ-T13 (Note)	5427CRZ	13"	28 Ld TSSOP (4.4mm) (Pb-Free)	MDP0044

NOTE: Intersil Pb-free plus anneal products employ special Pb-free material sets; molding compounds/die attach materials and 100% matte tin plate termination finish, which are RoHS compliant and compatible with both SnPb and Pb-free soldering operations. Intersil Pb-free products are MSL classified at Pb-free peak reflow temperatures that meet or exceed the Pb-free requirements of IPC/JEDEC J STD-020.

Pinouts

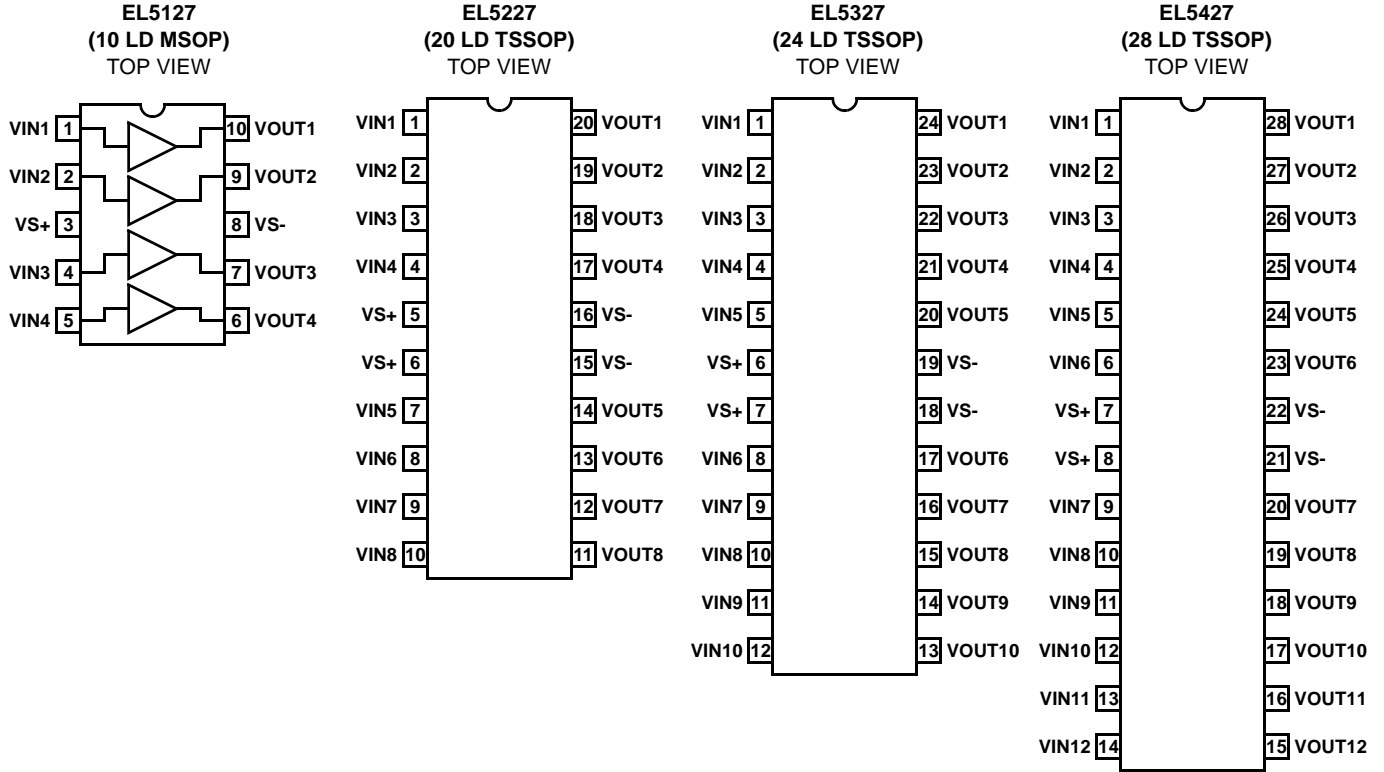

EL5227, EL5327  
(24 LD QFN)  
TOP VIEW

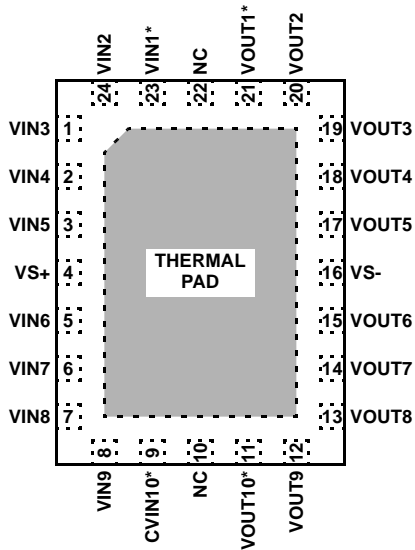

EL5427  
(32 LD QFN)  
TOP VIEW

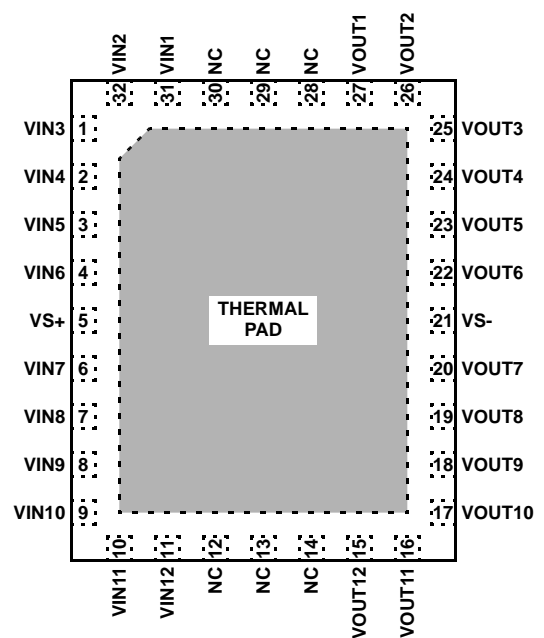

\* NOT AVAILABLE IN EL5227

# EL5127, EL5227, EL5327, EL5427

## Absolute Maximum Ratings (T<sub>A</sub> = +25°C)

Supply Voltage Between V <sub>S+</sub> and V <sub>S-</sub>	+18V
Input Voltage	V <sub>S-</sub> -0.5V, V <sub>S</sub> +0.5V
Maximum Continuous Output Current	30mA
ESD Voltage	.2kV

## Thermal Information

Maximum Die Temperature	+125°C
Storage Temperature	-65°C to +150°C
Power Dissipation	See Curves
Operating Temperature	-40°C to +85°C
Pb-free reflow profile	see link below <a href="http://www.intersil.com/pbfree/Pb-FreeReflow.asp">http://www.intersil.com/pbfree/Pb-FreeReflow.asp</a>

**CAUTION:** Stresses above those listed in "Absolute Maximum Ratings" may cause permanent damage to the device. This is a stress only rating and operation of the device at these or any other conditions above those indicated in the operational sections of this specification is not implied.

**IMPORTANT NOTE:** All parameters having Min/Max specifications are guaranteed. Typ values are for information purposes only. Unless otherwise noted, all tests are at the specified temperature and are pulsed tests, therefore: T<sub>J</sub> = T<sub>C</sub> = T<sub>A</sub>

## Electrical Specifications V<sub>S+</sub> = +5V, V<sub>S-</sub> = -5V, R<sub>L</sub> = 10kΩ, C<sub>L</sub> = 10pF to 0V, T<sub>A</sub> = +25°C, Unless Otherwise Specified.

PARAMETER	DESCRIPTION	CONDITIONS	MIN	TYP	MAX	UNIT
<b>INPUT CHARACTERISTICS</b>						
V <sub>OS</sub>	Input Offset Voltage	V <sub>CM</sub> = 0V		1	15	mV
TCV <sub>OS</sub>	Average Offset Voltage Drift	(Note 1)		5		μV/°C
I <sub>B</sub>	Input Bias Current	V <sub>CM</sub> = 0V		2	50	nA
R <sub>IN</sub>	Input Impedance			1		GΩ
C <sub>IN</sub>	Input Capacitance			1.35		pF
A <sub>V</sub>	Voltage Gain	-4.5V ≤ V <sub>OUT</sub> ≤ 4.5V	0.99		1.01	V/V
<b>OUTPUT CHARACTERISTICS</b>						
V <sub>OL</sub>	Output Swing Low	I <sub>L</sub> = -5mA		-4.95	-4.85	V
V <sub>OH</sub>	Output Swing High	I <sub>L</sub> = +5mA	4.85	4.95		V
I <sub>OUT</sub> (max)	Max Output Current (Note 2)	R <sub>L</sub> = 10Ω	100	±120		mA
<b>POWER SUPPLY PERFORMANCE</b>						
PSRR	Power Supply Rejection Ratio	V <sub>S</sub> is moved from ±2.25V to ±7.75V	55	80		dB
I <sub>S</sub>	Supply Current	No load (EL5127)		0.7	0.9	mA
		No load (EL5227)		1.2	1.4	mA
		No load (EL5327)		1.4	2	mA
		No load (EL5427)		1.6	2.2	mA
<b>DYNAMIC PERFORMANCE</b>						
SR	Slew Rate (Note 3)	-4.0V ≤ V <sub>OUT</sub> ≤ 4.0V, 20% to 80%	0.9	2.2		V/μs
t <sub>S</sub>	Settling to +0.1% (A <sub>V</sub> = +1)	(A <sub>V</sub> = +1), V <sub>O</sub> = 2V step		900		ns
BW	-3dB Bandwidth	R <sub>L</sub> = 10kΩ, C <sub>L</sub> = 10pF		2.5		MHz
CS	Channel Separation	f = 100kHz		75		dB

### NOTES:

1. Measured over operating temperature range.
2. Instantaneous peak current.
3. Slew rate is measured on rising and falling edges.

**EL5127, EL5227, EL5327, EL5427**

**Electrical Specifications**  $V_{S+} = +5V$ ,  $V_{S-} = 0V$ ,  $R_L = 10k\Omega$ ,  $C_L = 10pF$  to 2.5V,  $T_A = +25^\circ C$ , Unless Otherwise Specified.

PARAMETER	DESCRIPTION	CONDITION	MIN	TYP	MAX	UNIT
<b>INPUT CHARACTERISTICS</b>						
$V_{OS}$	Input Offset Voltage	$V_{CM} = 2.5V$		1	15	mV
$TCV_{OS}$	Average Offset Voltage Drift	(Note 4)		5		$\mu V/^\circ C$
$I_B$	Input Bias Current	$V_{CM} = 2.5V$		2	50	nA
$R_{IN}$	Input Impedance			1		$G\Omega$
$C_{IN}$	Input Capacitance			1.35		pF
$A_V$	Voltage Gain	$0.5V \leq V_{OUT} \leq 4.5V$	0.99		1.01	V/V
<b>OUTPUT CHARACTERISTICS</b>						
$V_{OL}$	Output Swing Low	$I_L = -5mA$		80	150	mV
$V_{OH}$	Output Swing High	$I_L = +5mA$	4.85	4.95		V
$I_{OUT(max)}$	Output Current (Note 5)	$R_L = 10\Omega$	100	$\pm 120$		mA
<b>POWER SUPPLY PERFORMANCE</b>						
PSRR	Power Supply Rejection Ratio	$V_S$ is moved from 4.5V to 15.5V	55	80		dB
$I_S$	Supply Current	No load (EL5127)		0.7	0.9	mA
		No load (EL5227)		1.1	1.35	mA
		No load (EL5327)		1.35	1.9	mA
		No load (EL5427)		1.5	2.05	mA
<b>DYNAMIC PERFORMANCE</b>						
SR	Slew Rate (Note 6)	$1V \leq V_{OUT} \leq 4V$ , 20% to 80%	0.9	1.5		$V/\mu s$
$t_S$	Settling to +0.1% ( $A_V = +1$ )	( $A_V = +1$ ), $V_O = 2V$ step		1000		ns
BW	-3dB Bandwidth	$R_L = 10k\Omega$ , $C_L = 10pF$		2.5		MHz
CS	Channel Separation	$f = 5MHz$		75		dB

**NOTES:**

4. Measured over operating temperature range.
5. Instantaneous peak current.
6. Slew rate is measured on rising and falling edges.

**EL5127, EL5227, EL5327, EL5427**

**Electrical Specifications**  $V_{S+} = +15V$ ,  $V_{S-} = 0V$ ,  $R_L = 10k\Omega$ ,  $C_L = 10pF$  to 7.5V,  $T_A = +25^\circ C$ , Unless Otherwise Specified.

PARAMETER	DESCRIPTION	CONDITION	MIN	TYP	MAX	UNIT
<b>INPUT CHARACTERISTICS</b>						
$V_{OS}$	Input Offset Voltage	$V_{CM} = 7.5V$		1	18	mV
$TCV_{OS}$	Average Offset Voltage Drift	(Note 7)		5		$\mu V/^\circ C$
$I_B$	Input Bias Current	$V_{CM} = 7.5V$		2	50	nA
$R_{IN}$	Input Impedance			1		$G\Omega$
$C_{IN}$	Input Capacitance			1.35		pF
$A_V$	Voltage Gain	$0.5V \leq V_{OUT} \leq 14.5V$	0.99		1.01	V/V
<b>OUTPUT CHARACTERISTICS</b>						
$V_{OL}$	Output Swing Low	$I_L = -5mA$		50	150	mV
$V_{OH}$	Output Swing High	$I_L = +5mA$	14.85	14.95		V
$I_{OUT(max)}$	Output Current (Note 8)	$R_L = 10\Omega$	100	$\pm 120$		mA
<b>POWER SUPPLY PERFORMANCE</b>						
PSRR	Power Supply Rejection Ratio	$V_S$ is moved from 4.5V to 15.5V	55	80		dB
$I_S$	Supply Current	No load (EL5127)		0.75	0.95	mA
		No load (EL5227)		1.3	1.55	mA
		No load (EL5327)		1.5	2.1	mA
		No load (EL5427)		1.6	2.4	mA
<b>DYNAMIC PERFORMANCE</b>						
SR	Slew Rate (Note 9)	$1V \leq V_{OUT} \leq 14V$ , 20% to 80%	0.9	2.2		$V/\mu s$
$t_S$	Settling to +0.1% ( $A_V = +1$ )	( $A_V = +1$ ), $V_O = 2V$ step		900		ns
BW	-3dB Bandwidth	$R_L = 10k\Omega$ , $C_L = 10pF$		2.5		MHz
CS	Channel Separation	$f = 5MHz$		75		dB

NOTES:

7. Measured over operating temperature range.
8. Instantaneous peak current.
9. Slew rate is measured on rising and falling edges.

Typical Performance Curves

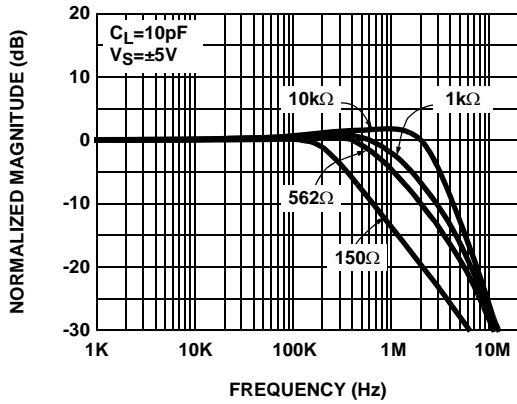

FIGURE 1. FREQUENCY RESPONSE FOR VARIOUS  $R_L$

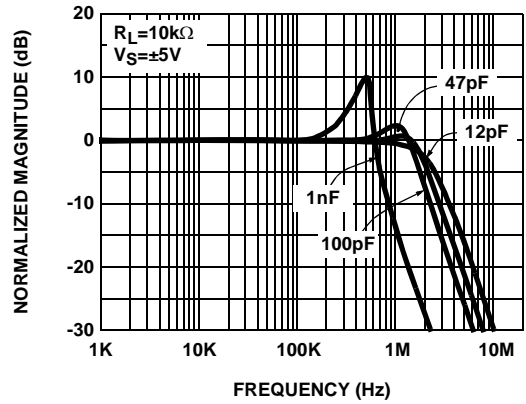

FIGURE 2. FREQUENCY RESPONSE FOR VARIOUS  $C_L$

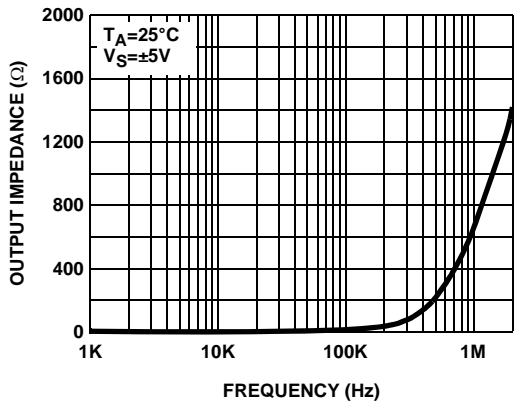

FIGURE 3. OUTPUT IMPEDANCE vs FREQUENCY

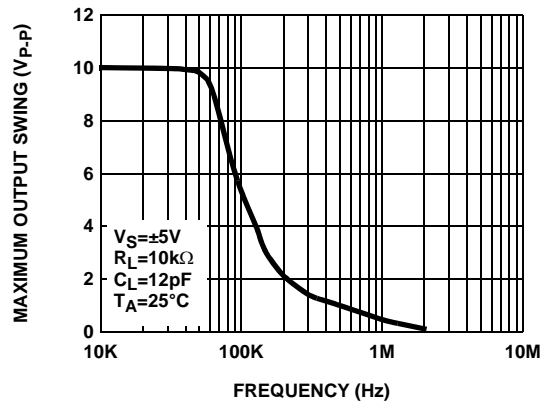

FIGURE 4. MAXIMUM OUTPUT SWING vs FREQUENCY

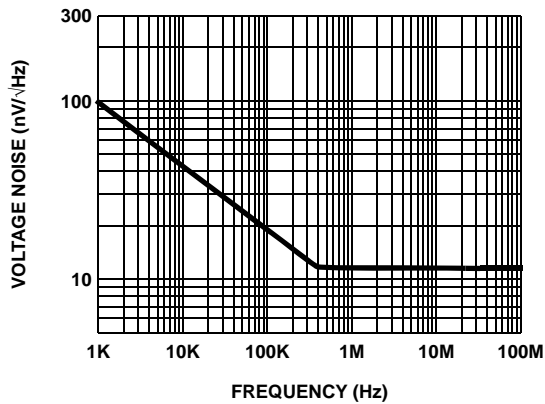

FIGURE 5. INPUT VOLTAGE NOISE SPECTRAL DENSITY vs FREQUENCY

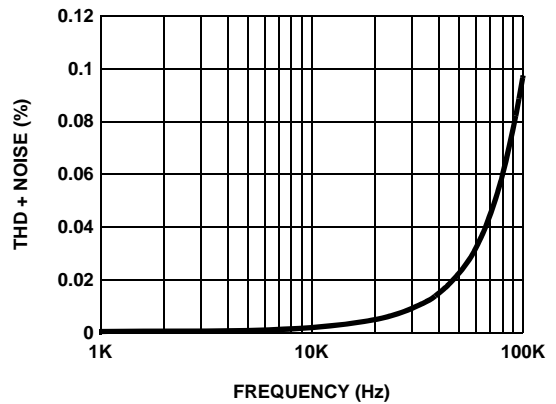

FIGURE 6. TOTAL HARMONIC DISTORTION + NOISE vs FREQUENCY



Typical Performance Curves

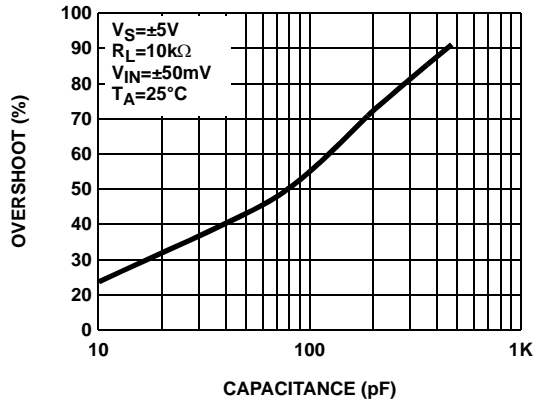

FIGURE 7. SMALL SIGNAL OVERSHOOT vs LOAD CAPACITANCE

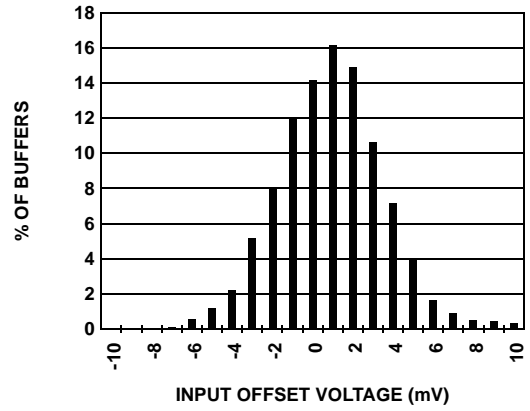

FIGURE 8. INPUT OFFSET VOLTAGE DISTRIBUTION

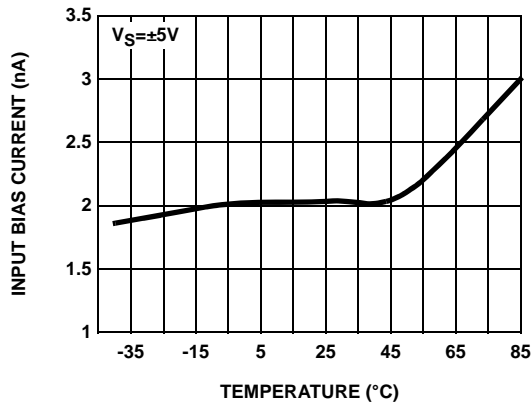

FIGURE 9. INPUT BIAS CURRENT vs TEMPERATURE

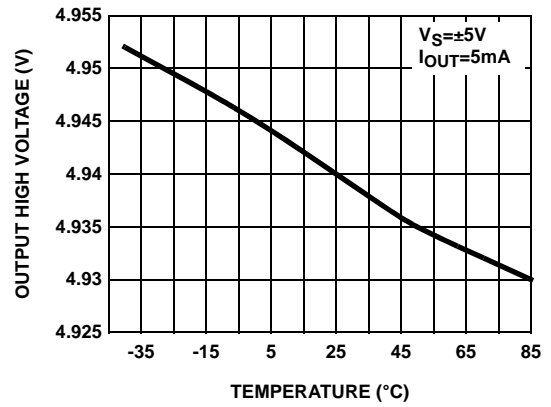

FIGURE 10. OUTPUT HIGH VOLTAGE vs TEMPERATURE

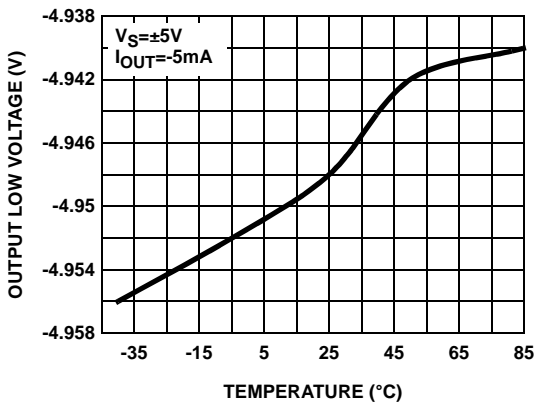

FIGURE 11. OUTPUT LOW VOLTAGE vs TEMPERATURE

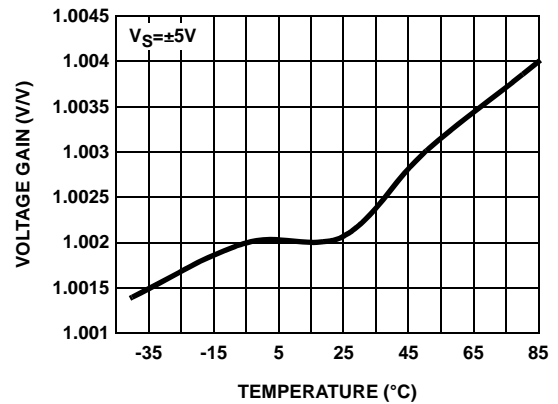

FIGURE 12. VOLTAGE GAIN vs TEMPERATURE

Typical Performance Curves

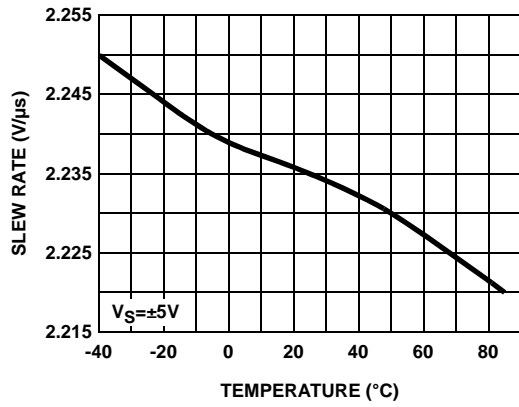

FIGURE 13. SLEW RATE vs TEMPERATURE

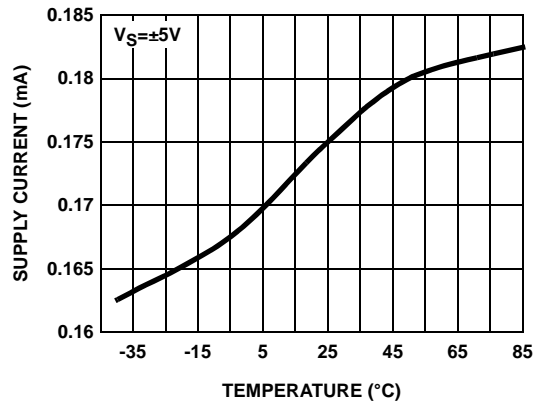

FIGURE 14. SUPPLY CURRENT PER CHANNEL vs TEMPERATURE

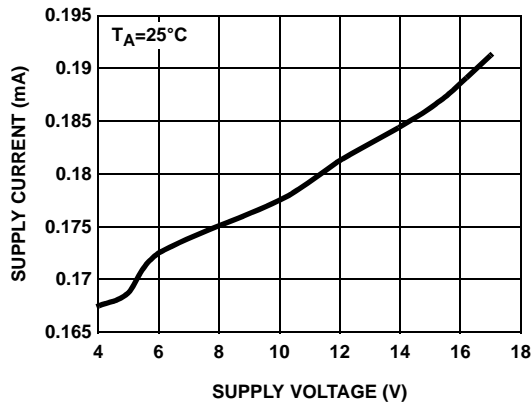

FIGURE 15. SUPPLY CURRENT PER CHANNEL vs SUPPLY VOLTAGE

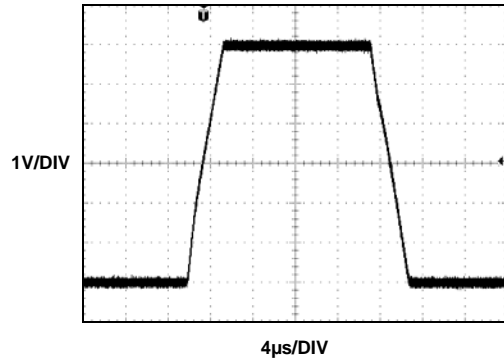

FIGURE 16. LARGE SIGNAL TRANSIENT RESPONSE

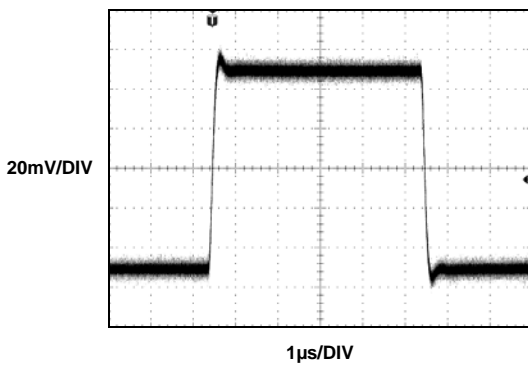

FIGURE 17. SMALL SIGNAL TRANSIENT RESPONSE

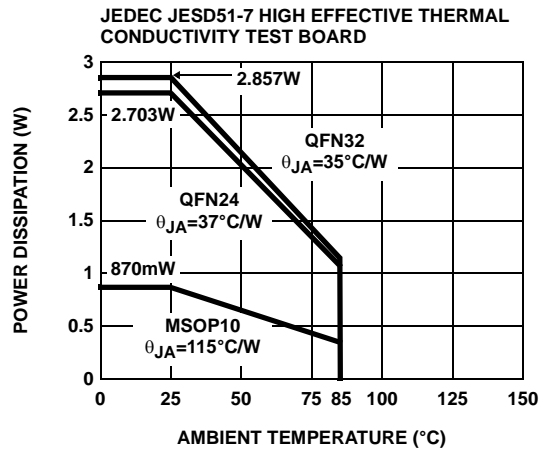

FIGURE 18. PACKAGE POWER DISSIPATION vs AMBIENT TEMPERATURE

Typical Performance Curves

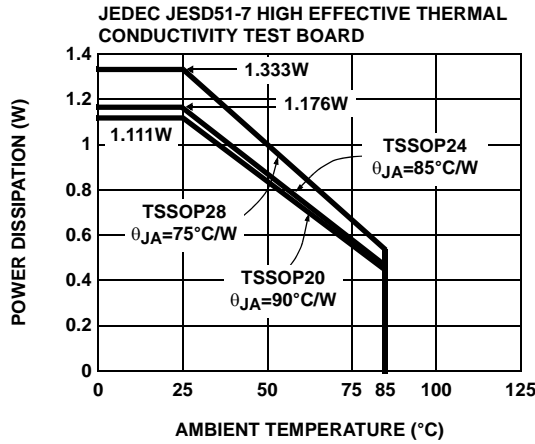

FIGURE 19. PACKAGE POWER DISSIPATION vs AMBIENT TEMPERATURE

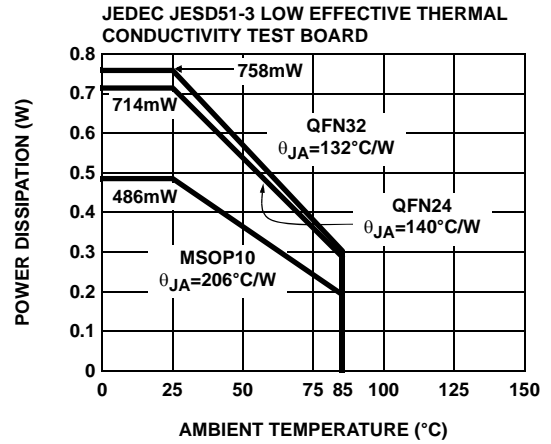

FIGURE 20. PACKAGE POWER DISSIPATION vs AMBIENT TEMPERATURE

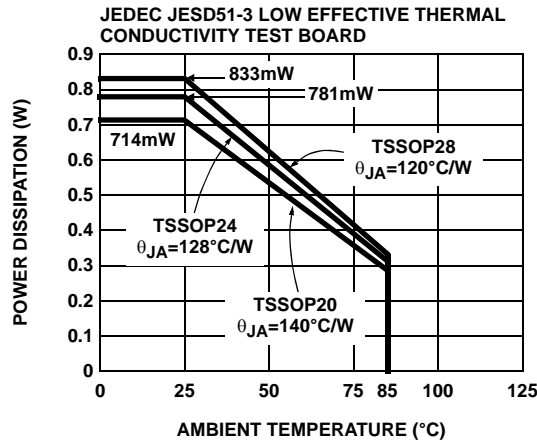

FIGURE 21. PACKAGE POWER DISSIPATION vs AMBIENT TEMPERATURE

Applications Information

Product Description

The EL5127, EL5227, EL5327, and EL5427 unity gain buffers are fabricated using a high voltage CMOS process. It exhibits rail-to-rail input and output capability and has low power consumption (120µA per buffer). These features make the EL5127, EL5227, EL5327, and EL5427 ideal for a wide range of general-purpose applications. When driving a load of 10kΩ and 12pF, the EL5127, EL5227, EL5327, and EL5427 have a -3dB bandwidth of 2.5MHz and exhibits 2.2V/µs slew rate.

Operating Voltage, Input, and Output

The EL5127, EL5227, EL5327, and EL5427 are specified with a single nominal supply voltage from 5V to 15V or a split supply with its total range from 5V to 15V. Correct operation is guaranteed for a supply range of 4.5V to 16.5V. Most EL5127, EL5227, EL5327, and EL5427 specifications are stable over both the full supply range and operating

temperatures of -40°C to +85°C. Parameter variations with operating voltage and/or temperature are shown in the typical performance curves.

The output swings of the EL5127, EL5227, EL5327, and EL5427 typically extend to within 80mV of positive and negative supply rails with load currents of 5mA. Decreasing load currents will extend the output voltage range even closer to the supply rails. Figure 22 shows the input and output waveforms for the device. Operation is from ±5V supply with a 10kΩ load connected to GND. The input is a 10V<sub>P-P</sub> sinusoid. The output voltage is approximately 9.985V<sub>P-P</sub>.

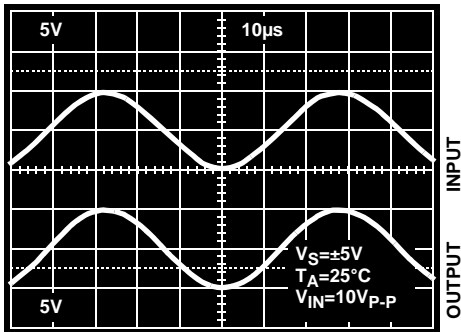

FIGURE 22. OPERATION WITH RAIL-TO-RAIL INPUT AND OUTPUT

**Short Circuit Current Limit**

The EL5127, EL5227, EL5327, and EL5427 will limit the short circuit current to ±120mA if the output is directly shorted to the positive or the negative supply. If an output is shorted indefinitely, the power dissipation could easily increase such that the device may be damaged. Maximum reliability is maintained if the output continuous current never exceeds ±30mA. This limit is set by the design of the internal metal interconnects.

**Output Phase Reversal**

The EL5127, EL5227, EL5327, and EL5427 are immune to phase reversal as long as the input voltage is limited from  $V_S - 0.5V$  to  $V_S + 0.5V$ . Figure 23 shows a photo of the output of the device with the input voltage driven beyond the supply rails. Although the device's output will not change phase, the input's overvoltage should be avoided. If an input voltage exceeds supply voltage by more than 0.6V, electrostatic protection diodes placed in the input stage of the device begin to conduct and overvoltage damage could occur.

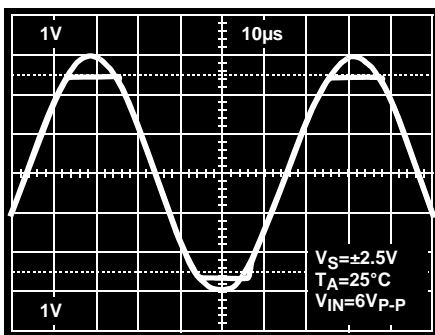

FIGURE 23. OPERATION WITH BEYOND-THE-RAILS INPUT

**Power Dissipation**

With the high-output drive capability of the EL5127, EL5227, EL5327, and EL5427 buffer, it is possible to exceed the +125°C “absolute-maximum junction temperature” under certain load current conditions. Therefore, it is important to calculate the maximum junction temperature for the

application to determine if load conditions need to be modified for the buffer to remain in the safe operating area.

The maximum power dissipation allowed in a package is determined according to:

$$P_{DMAX} = \frac{T_{JMAX} - T_{AMAX}}{\theta_{JA}}$$

where:

$T_{JMAX}$  = Maximum junction temperature

$T_{AMAX}$  = Maximum ambient temperature

$\theta_{JA}$  = Thermal resistance of the package

$P_{DMAX}$  = Maximum power dissipation in the package

The maximum power dissipation actually produced by an IC is the total quiescent supply current times the total power supply voltage, plus the power in the IC due to the loads, or:

$$P_{DMAX} = \sum i [V_S \times I_{SMAX} + (V_S + V_{OUT}^i) \times I_{LOAD}^i]$$

when sourcing, and:

$$P_{DMAX} = \sum i [V_S \times I_{SMAX} + (V_{OUT}^i - V_S^-) \times I_{LOAD}^i]$$

when sinking.

where:

$i$  = 1 to Total number of buffers

$V_S$  = Total supply voltage

$I_{SMAX}$  = Maximum quiescent current per channel

$V_{OUT}^i$  = Maximum output voltage of the application

$I_{LOAD}^i$  = Load current

If we set the two  $P_{DMAX}$  equations equal to each other, we can solve for  $R_{LOAD}^i$  to avoid device overheat. The package power dissipation curves provide a convenient way to see if the device will overheat. The maximum safe power dissipation can be found graphically, based on the package type and the ambient temperature. By using the previous equation, it is a simple matter to see if  $P_{DMAX}$  exceeds the device's power derating curves.

**Unused Buffers**

It is recommended that any unused buffer have the input tied to the ground plane.

### ***Driving Capacitive Loads***

The EL5127, EL5227, EL5327, and EL5427 can drive a wide range of capacitive loads. As load capacitance increases, however, the -3dB bandwidth of the device will decrease and the peaking increase. The buffers drive 10pF loads in parallel with 10k $\Omega$  with just 1.5dB of peaking, and 100pF with 6.4dB of peaking. If less peaking is desired in these applications, a small series resistor (usually between 5 $\Omega$  and 50 $\Omega$ ) can be placed in series with the output. However, this will obviously reduce the gain slightly. Another method of reducing peaking is to add a “snubber” circuit at the output. A snubber is a shunt load consisting of a resistor in series with a capacitor. Values of 150 $\Omega$  and 10nF are typical. The advantage of a snubber is that it does not draw any DC load current or reduce the gain.

### ***Power Supply Bypassing and Printed Circuit Board Layout***

As with any high frequency device, good printed circuit board layout is necessary for optimum performance. Ground plane construction is highly recommended, lead lengths should be as short as possible, and the power supply pins must be well bypassed to reduce the risk of oscillation. For normal single supply operation, where the V<sub>S-</sub> pin is connected to ground, a 0.1 $\mu$ F ceramic capacitor should be placed from V<sub>S+</sub> pin to V<sub>S-</sub> pin. A 4.7 $\mu$ F tantalum capacitor should then be connected from V<sub>S+</sub> pin to ground. One 4.7 $\mu$ F capacitor may be used for multiple devices. This same capacitor combination should be placed at each supply pin to ground if split supplies are to be used.

Mini SO Package Family (MSOP)

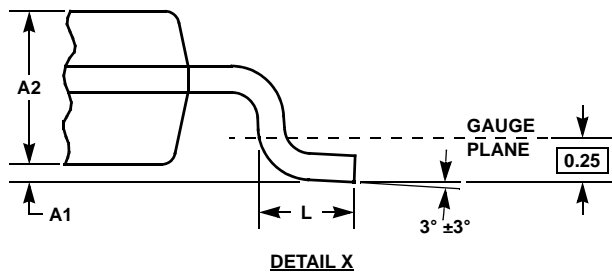
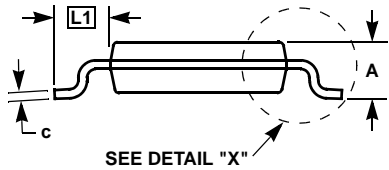
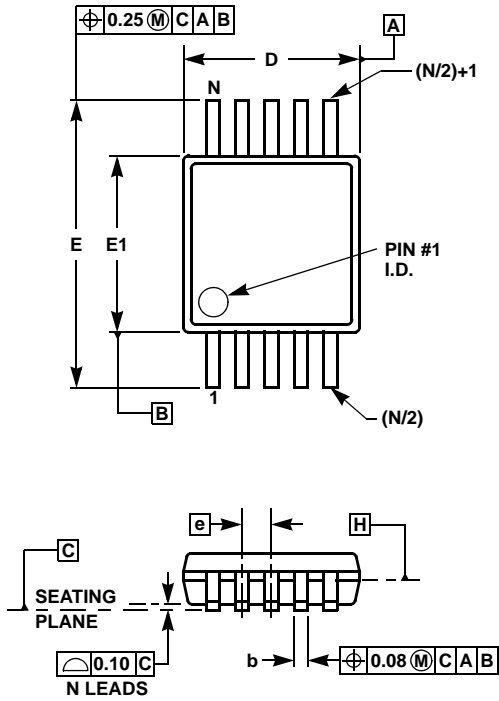

MDP0043  
MINI SO PACKAGE FAMILY

SYMBOL	MILLIMETERS		TOLERANCE	NOTES
	MSOP8	MSOP10		
A	1.10	1.10	Max.	-
A1	0.10	0.10	±0.05	-
A2	0.86	0.86	±0.09	-
b	0.33	0.23	+0.07/-0.08	-
c	0.18	0.18	±0.05	-
D	3.00	3.00	±0.10	1, 3
E	4.90	4.90	±0.15	-
E1	3.00	3.00	±0.10	2, 3
e	0.65	0.50	Basic	-
L	0.55	0.55	±0.15	-
L1	0.95	0.95	Basic	-
N	8	10	Reference	-

Rev. D 2/07

NOTES:

1. Plastic or metal protrusions of 0.15mm maximum per side are not included.
2. Plastic interlead protrusions of 0.25mm maximum per side are not included.
3. Dimensions "D" and "E1" are measured at Datum Plane "H".
4. Dimensioning and tolerancing per ASME Y14.5M-1994.

**QFN (Quad Flat No-Lead) Package Family**

**MDP0046**

QFN (QUAD FLAT NO-LEAD) PACKAGE FAMILY  
(COMPLIANT TO JEDEC MO-220)

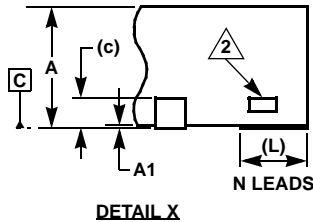
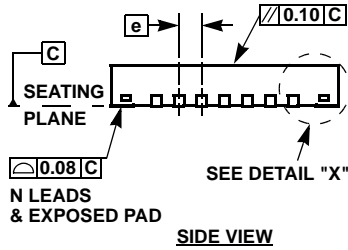
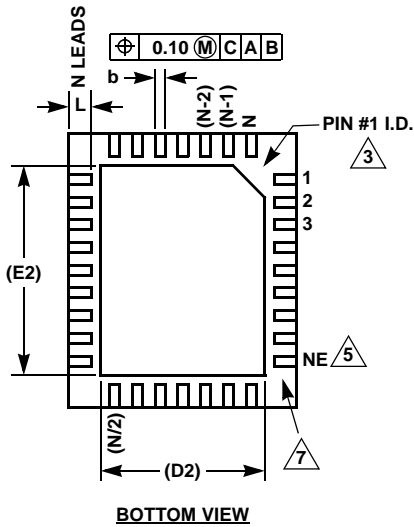
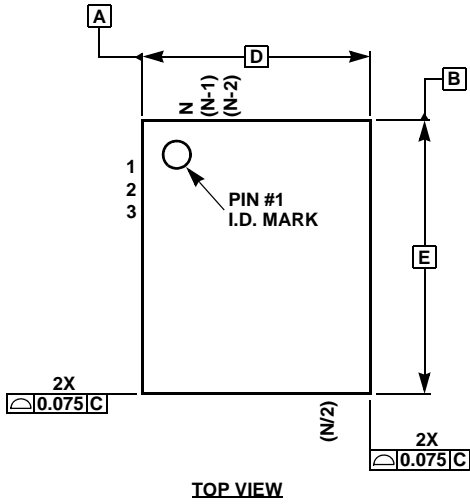

SYMBOL	MILLIMETERS				TOLERANCE	NOTES
	QFN44	QFN3	QFN32			
A	0.90	0.90	0.90	0.90	±0.10	-
A1	0.02	0.02	0.02	0.02	+0.03/-0.02	-
b	0.25	0.25	0.23	0.22	±0.02	-
c	0.20	0.20	0.20	0.20	Reference	-
D	7.00	5.00	8.00	5.00	Basic	-
D2	5.10	3.80	5.80	3.60/2.48	Reference	8
E	7.00	7.00	8.00	6.00	Basic	-
E2	5.10	5.80	5.80	4.60/3.40	Reference	8
e	0.50	0.50	0.80	0.50	Basic	-
L	0.55	0.40	0.53	0.50	±0.05	-
N	44	38	32	32	Reference	4
ND	11	7	8	7	Reference	6
NE	11	12	8	9	Reference	5

SYMBOL	MILLIMETERS					TOLERANCE	NOTES
	QFN28	QFN2	QFN20		QFN16		
A	0.90	0.90	0.90	0.90	0.90	±0.10	-
A1	0.02	0.02	0.02	0.02	0.02	+0.03/-0.02	-
b	0.25	0.25	0.30	0.25	0.33	±0.02	-
c	0.20	0.20	0.20	0.20	0.20	Reference	-
D	4.00	4.00	5.00	4.00	4.00	Basic	-
D2	2.65	2.80	3.70	2.70	2.40	Reference	-
E	5.00	5.00	5.00	4.00	4.00	Basic	-
E2	3.65	3.80	3.70	2.70	2.40	Reference	-
e	0.50	0.50	0.65	0.50	0.65	Basic	-
L	0.40	0.40	0.40	0.40	0.60	±0.05	-
N	28	24	20	20	16	Reference	4
ND	6	5	5	5	4	Reference	6
NE	8	7	5	5	4	Reference	5

Rev 11 2/07

**NOTES:**

1. Dimensioning and tolerancing per ASME Y14.5M-1994.
2. Tiebar view shown is a non-functional feature.
3. Bottom-side pin #1 I.D. is a diepad chamfer as shown.
4. N is the total number of terminals on the device.
5. NE is the number of terminals on the "E" side of the package (or Y-direction).
6. ND is the number of terminals on the "D" side of the package (or X-direction). ND = (N/2)-NE.
7. Inward end of terminal may be square or circular in shape with radius (b/2) as shown.
8. If two values are listed, multiple exposed pad options are available. Refer to device-specific datasheet.

Thin Shrink Small Outline Package Family (TSSOP)

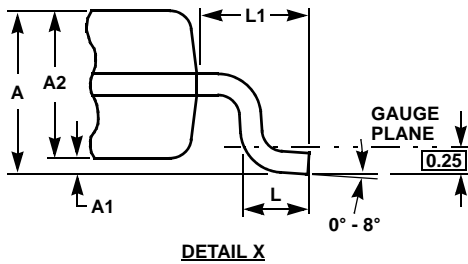
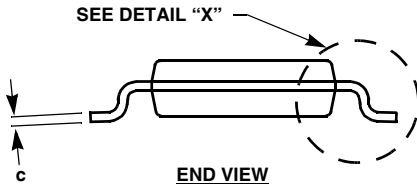
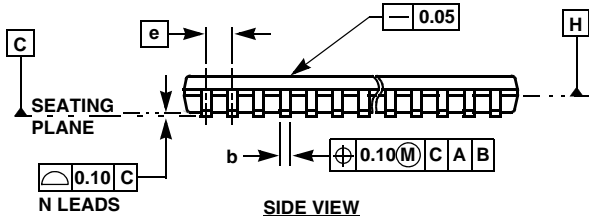
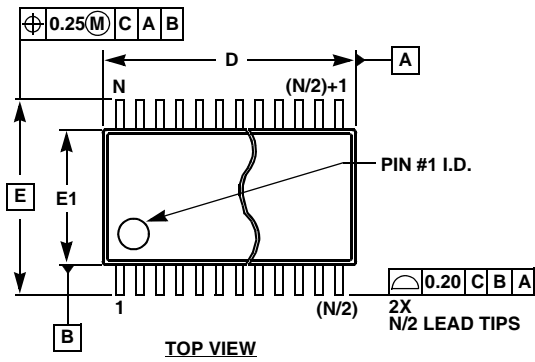

MDP0044

THIN SHRINK SMALL OUTLINE PACKAGE FAMILY

SYMBOL	MILLIMETERS					TOLERANCE
	14 LD	16 LD	20 LD	24 LD	28 LD	
A	1.20	1.20	1.20	1.20	1.20	Max
A1	0.10	0.10	0.10	0.10	0.10	±0.05
A2	0.90	0.90	0.90	0.90	0.90	±0.05
b	0.25	0.25	0.25	0.25	0.25	+0.05/-0.06
c	0.15	0.15	0.15	0.15	0.15	+0.05/-0.06
D	5.00	5.00	6.50	7.80	9.70	±0.10
E	6.40	6.40	6.40	6.40	6.40	Basic
E1	4.40	4.40	4.40	4.40	4.40	±0.10
e	0.65	0.65	0.65	0.65	0.65	Basic
L	0.60	0.60	0.60	0.60	0.60	±0.15
L1	1.00	1.00	1.00	1.00	1.00	Reference

Rev. F 2/07

NOTES:

1. Dimension "D" does not include mold flash, protrusions or gate burrs. Mold flash, protrusions or gate burrs shall not exceed 0.15mm per side.
2. Dimension "E1" does not include interlead flash or protrusions. Interlead flash and protrusions shall not exceed 0.25mm per side.
3. Dimensions "D" and "E1" are measured at dAtum Plane H.
4. Dimensioning and tolerancing per ASME Y14.5M-1994.



Thin Shrink Small Outline Plastic Packages (TSSOP)

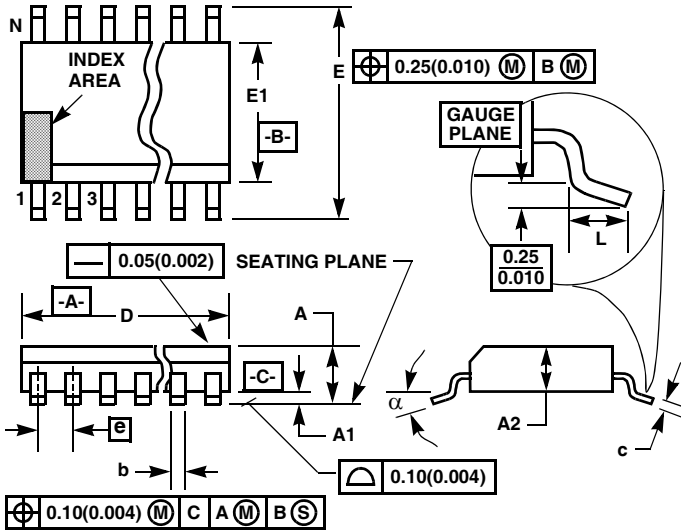

M20.173  
20 LEAD THIN SHRINK SMALL OUTLINE PLASTIC PACKAGE

SYMBOL	INCHES		MILLIMETERS		NOTES
	MIN	MAX	MIN	MAX	
A	-	0.047	-	1.20	-
A1	0.002	0.006	0.05	0.15	-
A2	0.031	0.051	0.80	1.05	-
b	0.0075	0.0118	0.19	0.30	9
c	0.0035	0.0079	0.09	0.20	-
D	0.252	0.260	6.40	6.60	3
E1	0.169	0.177	4.30	4.50	4
e	0.026 BSC		0.65 BSC		-
E	0.246	0.256	6.25	6.50	-
L	0.0177	0.0295	0.45	0.75	6
N	20		20		7
$\alpha$	0°	8°	0°	8°	-

NOTES:

- These package dimensions are within allowable dimensions of JEDEC MO-153-AC, Issue E.
- Dimensioning and tolerancing per ANSI Y14.5M-1982.
- Dimension "D" does not include mold flash, protrusions or gate burrs. Mold flash, protrusion and gate burrs shall not exceed 0.15mm (0.006 inch) per side.
- Dimension "E1" does not include interlead flash or protrusions. Interlead flash and protrusions shall not exceed 0.15mm (0.006 inch) per side.
- The chamfer on the body is optional. If it is not present, a visual index feature must be located within the crosshatched area.
- "L" is the length of terminal for soldering to a substrate.
- "N" is the number of terminal positions.
- Terminal numbers are shown for reference only.
- Dimension "b" does not include dambar protrusion. Allowable dambar protrusion shall be 0.08mm (0.003 inch) total in excess of "b" dimension at maximum material condition. Minimum space between protrusion and adjacent lead is 0.07mm (0.0027 inch).
- Controlling dimension: MILLIMETER. Converted inch dimensions are not necessarily exact. (Angles in degrees)

Rev. 1 6/98

All Intersil U.S. products are manufactured, assembled and tested utilizing ISO9000 quality systems. Intersil Corporation's quality certifications can be viewed at [www.intersil.com/design/quality](http://www.intersil.com/design/quality)

*Intersil products are sold by description only. Intersil Corporation reserves the right to make changes in circuit design, software and/or specifications at any time without notice. Accordingly, the reader is cautioned to verify that data sheets are current before placing orders. Information furnished by Intersil is believed to be accurate and reliable. However, no responsibility is assumed by Intersil or its subsidiaries for its use; nor for any infringements of patents or other rights of third parties which may result from its use. No license is granted by implication or otherwise under any patent or patent rights of Intersil or its subsidiaries.*

For information regarding Intersil Corporation and its products, see [www.intersil.com](http://www.intersil.com)