

用途	车载等级
特点	AEC-Q200
	电源线用
系列	ACH
状态	量产体制(新设计非推荐)
	推荐代替型号 : YFF18AC1H472MT0Y0N (不保证其兼容性。)



尺寸

长度(L)	3.20mm ±0.30mm
宽度(W)	1.80mm ±0.20mm
厚度(T)	2.50mm ±0.25mm

电气特性

插入损耗 [Typ.]	25dB (45MHz~105MHz)
截止频率 [Typ.]	
额定电压 [Max.]	20V
额定电流 [Max.]	1.5A
直流电阻 (Max.)	
额定电容 [Typ.]	

其他

电路型	T Type
传输线路	单端
使用温度范围	-40~125° C
焊接方法	回流
	烙铁焊接
AEC-Q200	YES
包装形式	塑封编带 (180mm卷筒)
包装个数	1000pcs
重量	0.07g

特性图表 (这是参考数据，并不保证产品的特性。)

Associated Images

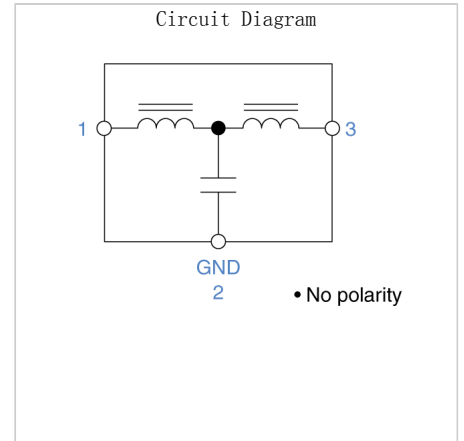
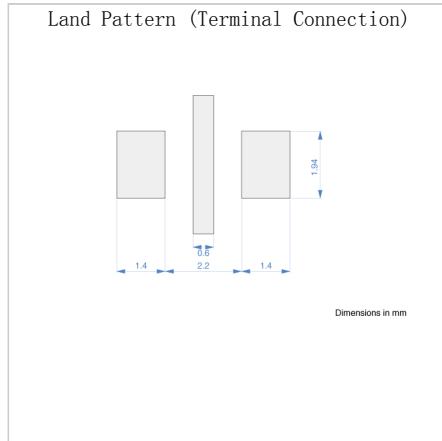
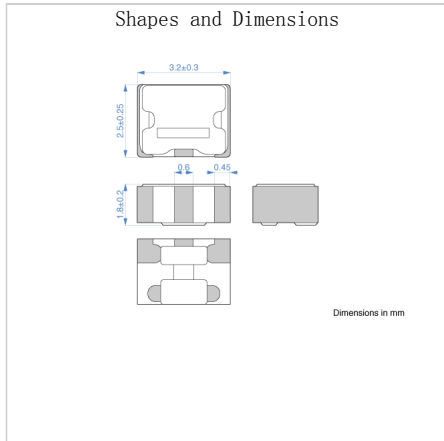

! Images are for reference only and show exemplary products.
 ! This PDF document was created based on the data listed on the TDK Corporation website.
 ! All specifications are subject to change without notice.