

单端式

B41866C4188M008

RoHS Reach Pb Free

型	B41866
特点	High ripple current
状态	 量产体制



尺寸

D x L 12.5mm x 25mm

其他详细信息 [请参照规格书](#)

电气特性

额定电容	1800 μ F
额定电压 [DC]	16V
额定纹波电流	1.358A (100kHz, 125° C)
最大ESR	0.089 Ω (10kHz, 20° C)
最大阻抗	0.082 Ω (100kHz, 20° C)

其他详细信息 [请参照规格书](#)

其他

最低温度	-55° C
上限工作温度	125° C
额定使用寿命	>5000h
端子和封装数据	Taped leads, Ammo pack_lead spacing F=5.0 mm

包装形式 [请参照规格书](#)

Associated Images

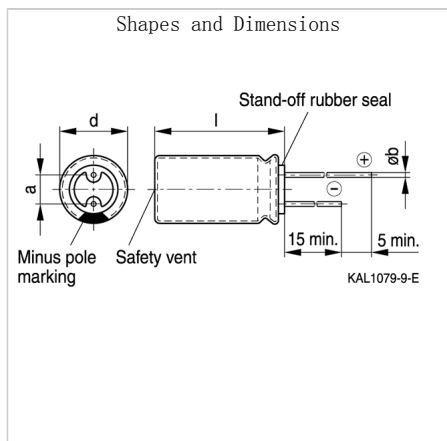

! Images are for reference only and show exemplary products.
! This PDF document was created based on the data listed on the TDK Corporation website.
! All specifications are subject to change without notice.