

单端式

B41866C4338M002

RoHS Reach Pb Free

型	B41866
特点	High ripple current
状态	 量产体制



尺寸

D x L 18mm x 25mm

其他详细信息 [请参照规格书](#)

电气特性

额定电容 3300 μ F

额定电压 [DC] 16V

额定纹波电流 2.454A (100kHz, 125° C)

最大ESR 0.039 Ω (10kHz, 20° C)

最大阻抗 0.037 Ω (100kHz, 20° C)

其他详细信息 [请参照规格书](#)

其他

最低温度 -55° C

上限工作温度 125° C

额定使用寿命 >5000h

端子和封装数据 Cut leads, bulk

包装形式 [请参照规格书](#)

Associated Images

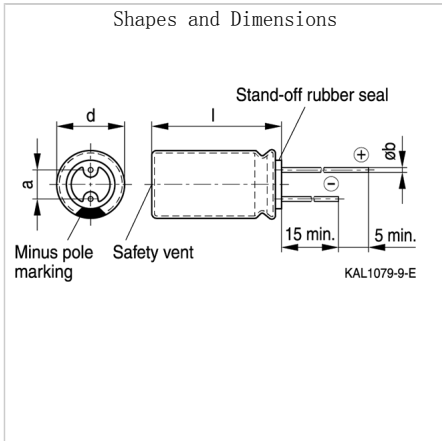

! Images are for reference only and show exemplary products.
 ! This PDF document was created based on the data listed on the TDK Corporation website.
 ! All specifications are subject to change without notice.