

单端式

B41866C6826M008

RoHS Reach Pb Free

型	B41866
特点	High ripple current
状态	 量产体制



尺寸

D x L 8mm x 11.5mm

其他详细信息 [请参照规格书](#)

电气特性

额定电容 82 μ F

额定电压 [DC] 50V

额定纹波电流 0.37A (100kHz, 125° C)

最大ESR 0.646 Ω (10kHz, 20° C)

最大阻抗 0.573 Ω (100kHz, 20° C)

其他详细信息 [请参照规格书](#)

其他

最低温度 -55° C

上限工作温度 125° C

额定使用寿命 >2000h

端子和封装数据 Taped leads, Ammo pack_lead spacing F=5.0 mm

包装形式 [请参照规格书](#)

! Images are for reference only and show exemplary products.

! This PDF document was created based on the data listed on the TDK Corporation website.

! All specifications are subject to change without notice.

Associated Images

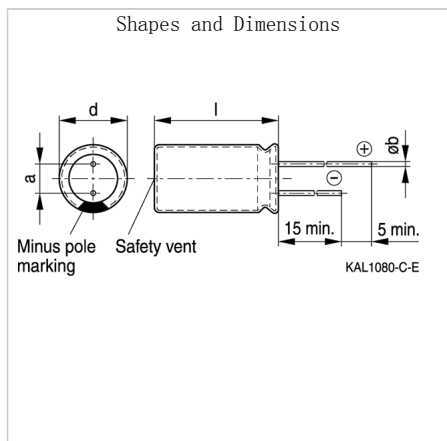

! Images are for reference only and show exemplary products.
! This PDF document was created based on the data listed on the TDK Corporation website.
! All specifications are subject to change without notice.