

单端式

B41888C4337M008

RoHS Reach Pb Free

型	B41888
特点	Long useful life, Low impedance
状态	 量产体制



尺寸

D x L 8mm x 11.5mm

其他详细信息 [请参照规格书](#)

电气特性

额定电容 330 μ F

额定电压 [DC] 16V

额定纹波电流 0.69A (100kHz, 105° C)

最大ESR 0.204 Ω (10kHz, 20° C)

最大阻抗 0.183 Ω (100kHz, 20° C)

其他详细信息 [请参照规格书](#)

其他

最低温度 -55° C

上限工作温度 105° C

额定使用寿命 >5000h

端子和封装数据 Taped leads, Ammo pack_lead spacing F=5.0 mm

包装形式 [请参照规格书](#)

! Images are for reference only and show exemplary products.

! This PDF document was created based on the data listed on the TDK Corporation website.

! All specifications are subject to change without notice.

单端式

B41888C4337M008

RoHS Reach Pb Free

Associated Images

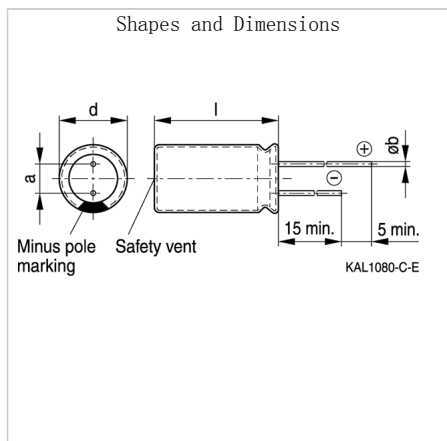

! Images are for reference only and show exemplary products.
 ! This PDF document was created based on the data listed on the TDK Corporation website.
 ! All specifications are subject to change without notice.